

LENS CLEANERS

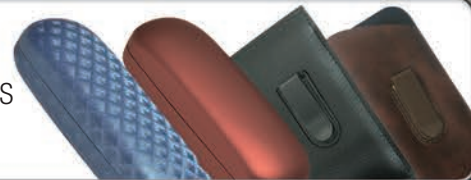

EYEGLOSS CASES



ACCESSORIES



DISPENSING



OPTOMETRIC



SURFACING



FINISHING



TOOLS



FRAME PARTS



# THE OPTICAL SUPPLY RESOURCE



1-800-OptiSource (678-4768)

1-800-OptiSource.com

# Over 1 Million Sold



Thank you to our loyal customers for making All Off the most widely used marking ink remover.

Lens Cleaners 3-18



Eyeglass Cases 19-30



Accessories 31-92



Dispensing 93-104



Optometric 105-126



Surfacing 127-140

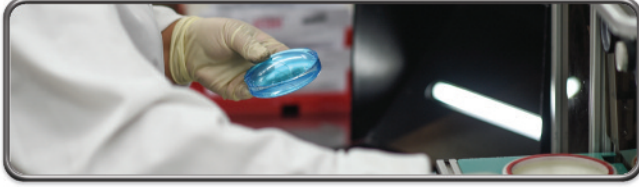

Finishing 141-178



Tools 179-216



Frame Parts 217-233



Index 234-239

Terms & Conditions 240

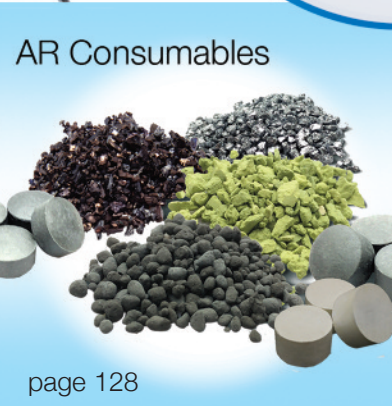
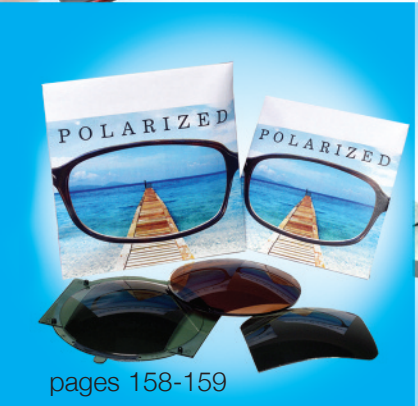
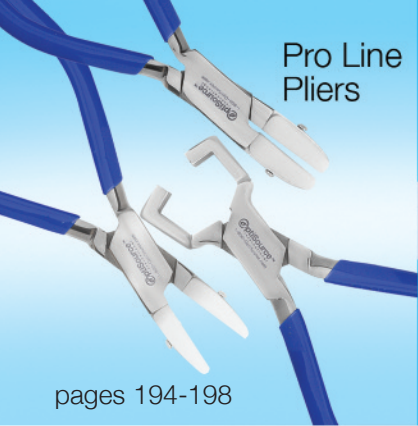

# Lens Cleaners



# Lens Cleaner Kits

Lens cleaner kits are available with any lens cleaner label. Pair it with a coordinating cloth color for maximum appeal (see pages 10-12 for available cloth colors).

- Six packaging options
- Imprinting available

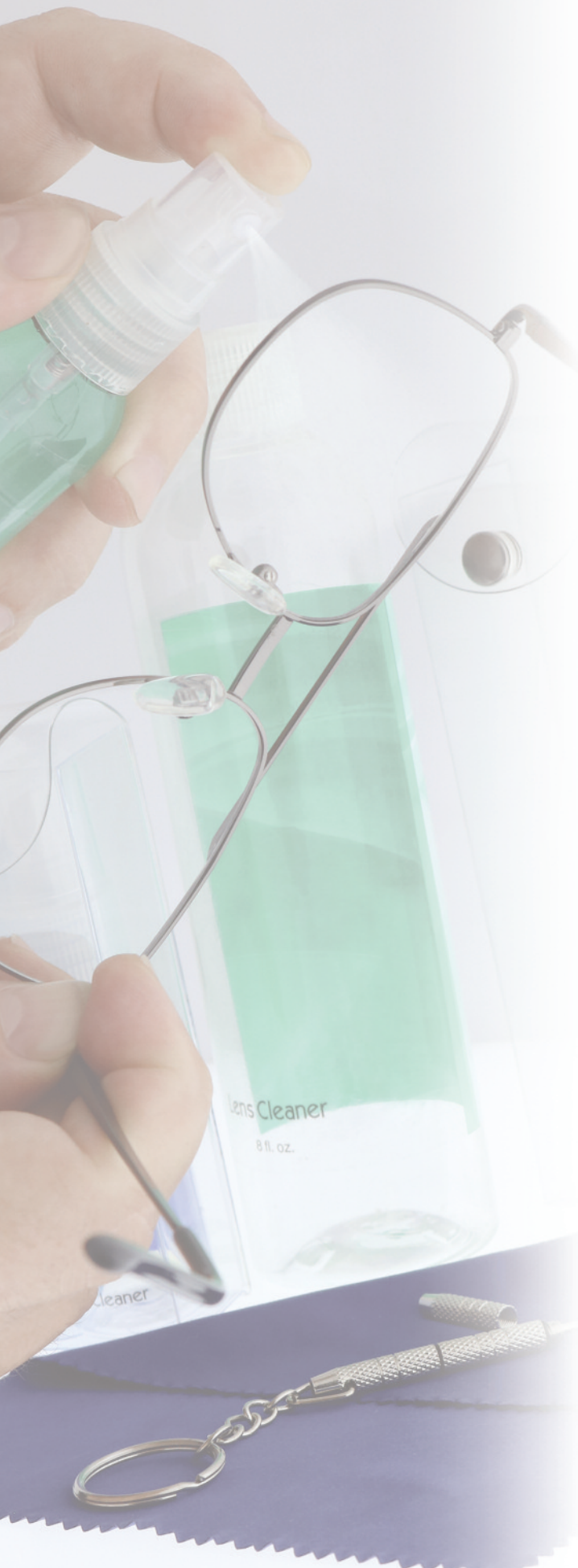

Snap Pouch  
1 or 2 oz.



Silver Ribbon  
2 oz. only



Plastic Box  
1 oz.



Hang Tag  
2 oz. only



Drawstring Bag  
1 or 2 oz.



Shrink Sleeve Combo  
1 oz. Cleaner / 8 oz. Refill



Optional 3-way keychain screwdriver available with drawstring bag, snap pouch, or plastic box kits.

Call customer service to order.

1-800-OptiSource (678-4768)

# Premium Lens Cleaners

## Wave Label

Our newest lens cleaner label maximizes your imprint visibility. The contemporary design is available in four vibrant colors and is sure to be a new favorite among patients.

### How to Order

1. Build item number beginning with 99-LCW
2. Add color code.  
Example: Unprinted Green Wave 2 oz.: 99-LCWG
3. Add size code.  
Example: Unprinted Green Wave 2 oz.: 99-LCWG2-72
4. For imprinting\* add P  
Example: Imprinted Green Wave 2 oz.: 99-LCWG2P-72

### Quantity/Prices for Non-Imprinted Cleaners

Size	Case Qty.	Price Ea.
1 oz.	72	\$0.79
2 oz.	72	\$0.94
4 oz.	50	\$1.34
8 oz.	24	\$1.69

For imprinting add \$0.05 to price.

\* Two case minimum order for imprinting.



Color Codes: Green (G) Blue (B) Orange (O) Purple (P)  
 Size Codes: 1 oz. (1-72) 2 oz. (2-72) 4 oz. (4-50) 8 oz. (8-24)

## Clear Label



The elegance of a black imprint with a clear liquid and a matching black sprayer are sure to enhance your brand.



Item	Unit	Case Qty.	Code	Price Ea.
Imprinted	1 oz.	72	99-LCC1P-72	\$0.84
Imprinted	2 oz.	72	99-LCC2P-72	\$0.99

\* Two case minimum order for imprinting.

## Clear View Label

Clear View has been a trusted brand in premium lens cleaners for over twenty years. The mild formula is proven to be safe and effective on all lenses and coatings.



Size Codes: 1 oz. (1-72) 2 oz. (2-72) 4 oz. (4-50) 8 oz. (8-24)



# Custom Bottle. Custom Color. Custom Label.

The most versatile and customizable lens cleaner packaging in the industry.

- Unique flat bottle design is perfect for handling and storing in pockets and purses
- Wide range of lens cleaner liquid colors to choose from
- Hundreds of label design and color combinations
- 2 oz. spray bottle

## Choose the Lens Cleaner Color



Blue Clear Purple Green Ice

## Select from Hundreds of Label Designs and Colors



Direct Printing

## Choose a Cloth

Want the sleekest lens cleaner kit? Add a custom die-cut cloth in a plastic carrying case that sticks to the back of the Custom Clean bottle so it is always handy.

- Embossed microfiber cloth with rounded edges
- Cloth measures 6 x 3.5"



**\$1.09**  
each  
50 per box

**\$1.79**  
each  
50 per box

### Lens Cleaner

Purple	99-LC3P
Blue	99-LC3B
Green	99-LC3G
Ice	99-LC3I
Clear	99-LC3C

### Cleaner with Cloth (Kit)

Purple	99-LC3KP
Blue	99-LC3KB
Green	99-LC3KG
Ice	99-LC3KI
Clear	99-LC3KC

For imprinting add \$0.10 to price.

200 pc. minimum order for imprinting. Cloth not printable.



## Display

Holds 24 cleaners.  
Cleaners not included.  
Display free with order  
of 200 bottles.



99-LC3DISPLAY \$29.99

## Customize and Order Online!

The magic behind Custom Clean happens online with our proprietary customization ordering engine.

- Watch your lens cleaner package get built as you select colors, labels, imprinting type, and font colors
- Upload logos, or choose from our stock optical logos and icons
- Make changes in real-time!

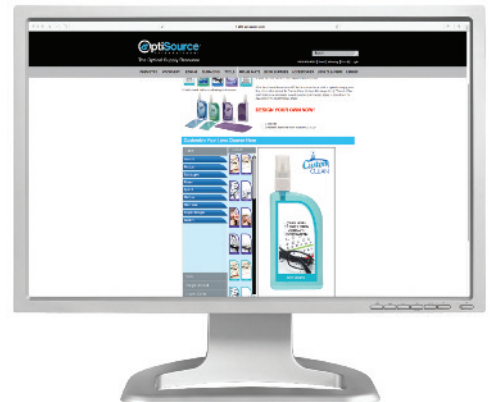

[1-800-OptiSource.com/Custom-Clean](http://1-800-OptiSource.com/Custom-Clean)



# Kool Klean Kit

The Cool Way to Clean Glasses

Kool Klean is a patent pending, creative lens care kit. Inside one lens of this "Kool" sunglass shaped case is a refillable 15ml bottle of lens cleaner good for over 100 cleanings. Inside the other lens is a 4x7" full size microfiber cleaning cloth. The cloth quickly stashes in its covered case to keep it clean and protected from debris.

- Novel lens care kit
- Refillable spray cleaner and microfiber cloth
- Available in four fun colors
- 24 kits per box

\$1.99 each



- Assorted 97-KOOL-AST
- Black 97-KOOL-BK
- Lime 97-KOOL-LI
- Blue 97-KOOL-BL
- Purple 97-KOOL-PR



# Aktiv Lens Cleaner Kit

All-In-One Sporty, Compact Kit

Our Aktiv lens cleaner is a cloth and cleaner, all-in-one, compact kit. The refillable 10ml spray cleaner is AR safe, and fast-drying. The silky microfiber cloth is attached with a strap that retracts the cloth back into the Aktiv kit when pulled. A handy carabiner allows Aktiv to attach to any loop.

- Cloth and cleaner kit
- Refillable
- 24 kits per box



16 piece display. Cleaners not included.

- 97-LCSPORT Each \$2.59
- 97-LCSPORTSDisplay Each \$24.99



Spray



Clean



Retract

## LENS CLEANERS

### Lens Cleaner Refill

Refill customer or dispensary lens cleaner bottles.  
Choose from one gallon size or 2.5 gallon cubitainer with spigot.

- Available in clear or purple cleaner



#### Purple Cleaner

99-LCG	Gallon	\$24.99
99-LCD	2.5 Gallon	\$59.99

#### Clear Cleaner

99-LCGC	Gallon	\$24.99
99-LCDC	2.5 Gallon	\$59.99

### Economy Squeeze Lens Cleaner



This 1oz. economy lens cleaner is ideal to use as a giveaway promotional item. The drip top container dispenses drops of cleaner to the lens surface.

- Economy priced
- 50 bottles per case

Unprinted	47-LC1SQZ	Each	\$ .39
Imprinted	47-LC1SQZ-PL	Each	\$ .49

\* Two case minimum order for imprinting

### Fog Free™ Anti-Fog Cleaner



Fog Free™ is a temporary defogging cleaner that is safe and effective on most lenses (does not work on AR coatings).

- Cleans and puts an anti-static charge on lens
- Works great on dive masks
- 2 oz. bottle
- 72 bottles per box

99-LCFF	2 oz.	Each	\$1.59
99-LCFFG	Gallon		\$29.99

### Compact Lens Cleaner Display



Our new two-step acrylic display is designed to save counter space and provide a simple, yet stylish way to offer lens cleaners.

- Small footprint: 6"L x 6"W x 6"H

47-COMPACTLCDISPLAY \$29.99

### Universal Lens Cleaner Display



Our acrylic universal lens cleaner display holds a variety of different style cleaners, kits or cloths. Fill the display with your best selling lens care products.

- Small footprint: 13"L x 7 1/8"W x 6 1/4"H
- Holds a variety of cloths and cleaners

47-LCDISPLAY \$39.99

Products not included

### Pre-Moistened Lens Wipes

- Safe on all AR coatings
- Easily carried in a wallet or purse
- 5.25" x 6" cloth



99-MW20	20 Wipe packs	\$2.59
99-MW20C	24 Boxes (Case)	\$37.99

# Card Cleaner Kit

The credit card sized kit measures just 2 1/4" x 3 1/4" x 3/8". The super slim design allows the Card Cleaner Kit to fit discretely into pockets, purses, carrying cases, and anywhere else a round or bulky cleaner would not be desirable.

- 20ml rectangular spray bottle of lens cleaner
- 6" x 5 3/4" silky microfiber cloth
- 25 assorted-color cleaner kits per box

97-CARDASST Each \$1.79

\* For imprinting add "PL" to the code + \$0.15  
(Minimum 250 Pieces)  
Cloth not imprintable. Imprinting on case only.



Plastic pouch holds a business or appointment recall card

# Luxury Cleaner Kit

We decided it's time to break the mold on lens cleaner design with the new Luxury Cleaner Kit. The fashion-forward design is trendy, unique and sure to be a hit with your customers. The front of the cleaner is imprintable with your company's information.

- 30ml oval spray bottle
- 7" x 6 3/4" designer pattern cloth with sewn edges
- 25 assorted-color cleaner kits per box

97-LUXASST Each \$2.29

\* For imprinting add "PL" to the code + \$0.15  
(Minimum 250 Pieces)  
Cloth not imprintable. Imprinting on spray bottle only.



# Mini Clean

The ultra-compact lens care kit easily stashes inside pockets, purses, and carrying cases. The microfiber cloth conveniently stores inside the cap.

- 1 oz. refillable travel-size bottle
- Mini 1 3/4" x 3" x 1 1/8" size
- 4" x 5" gray microfiber cloth
- 50 cleaners per box

99-LCMC-50 Each \$1.79

\* For imprinting add "PL" to the code + \$0.15  
(Minimum 250 Pieces)  
Cloth not imprintable. Imprinting on spray bottle only.  
\$30 one-time plate charge.



# LENS CLEANERS

## Basic Cloths

Our popular Basic cloths are a value-priced alternative to Premium microfiber. The generous size and smooth finish allow for easy, safe cleaning.

- 6" x 7" smooth fabric
- Packaged 100 to a box



**59¢**  
each

### Loose

**BUY MORE, SAVE MORE!**

	Quantity	Price Each	
Black	99-331-0104		
Burgundy	99-331-0103	100 - 500	\$ .59
Gray	99-331-0107		
Navy	99-331-0106	600 - 1,000	\$ .49
Red	99-331-0102		
Sky Blue	99-331-0105	1,100 - 2,400	\$ .39
White	99-331-0101	2,500+	\$ .29

For imprinting add "PL" to the code + \$0.10

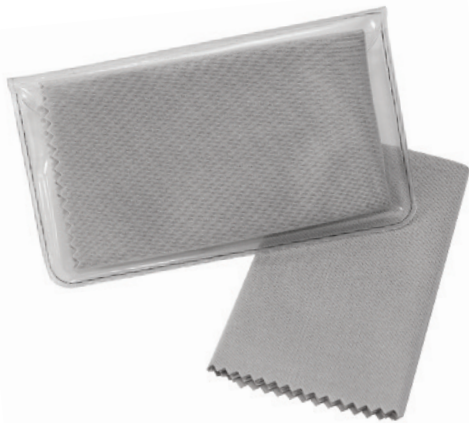
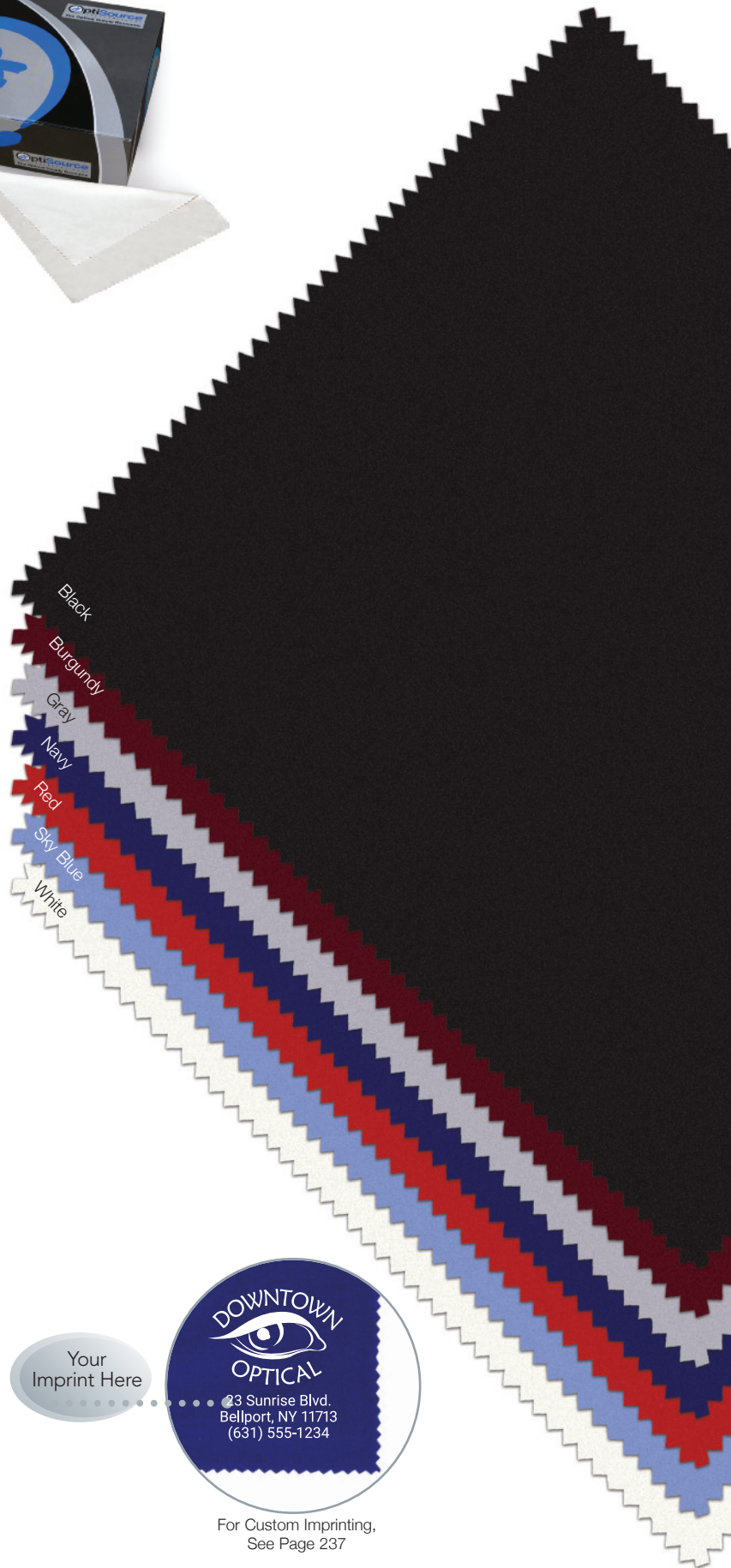

**69¢**  
each

### Cloth-In-Case

**BUY MORE, SAVE MORE!**

	Quantity	Price Each	
Black	99-331-0204		
Burgundy	99-331-0203	100 - 500	\$ .69
Gray	99-331-0207		
Navy	99-331-0206	600 - 1,000	\$ .59
Red	99-331-0202		
Sky Blue	99-331-0205	1,100 - 2,400	\$ .49
White	99-331-0201	2,500+	\$ .39

For imprinting add "PL" to the code + \$0.10

Your Imprint Here



For Custom Imprinting,  
See Page 237

# Premium Microfiber Cloths

These high thread-count cloths are made of the best quality microfiber available. They are heavy-weight, resilient and incredibly smooth. The microfiber properties allow for superior cleaning even without a spray cleaner. OptiSource cloths are safe on AR coatings, all lenses, screens, and monitors.

- Silky weave traps dust and oils for safe cleaning
- 6" x 7" silky, close-knit fabric
- Packaged 100 to a box

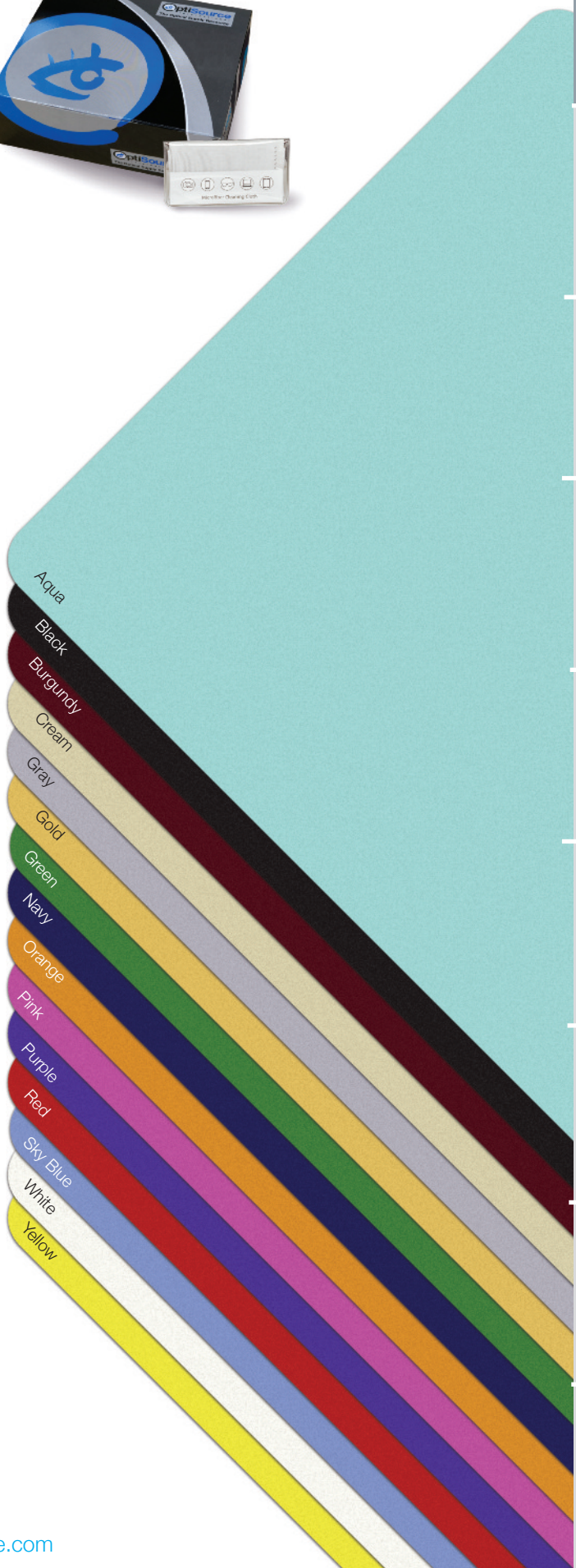

LENS CLEANER  
CASES  
ACCESSORIES  
DISPENSING  
OPTOMETRIC  
SURFACING  
FINISHING  
TOOLS  
FRAME PARTS

84¢  
each

## Loose

**BUY MORE, SAVE MORE!**

		Quantity	Price Each
Aqua	33-LCAQLZ		
Black	33-LCBLLZ		
Burgundy	33-LCBULZ	100 - 500	\$ .84
Cream	33-LCCRLZ		
Gray	33-LCGRLZ	600 - 1,000	\$ .79
Gold	33-LCGLLZ		
Green	33-LCGNLZ	1,100 - 1,500	\$ .74
Navy	33-LCNALZ		
Orange	33-LCORLZ	1,600 - 2,400	\$ .69
Pink	33-LCPKLZ		
Purple	33-LCPRLZ	2,500+	\$ .59
Red	33-LCRELZ		
Sky Blue	33-LCSBLZ		
White	33-LCWHLZ		
Yellow	33-LCYELZ		

For imprinting add "PL" to the code + \$0.10



99¢  
each

## Cloth-In-Case

**BUY MORE, SAVE MORE!**

		Quantity	Price Each
Aqua	33-LCAQCZ		
Black	33-LCBLCZ		
Burgundy	33-LCBUCZ	100 - 500	\$ .99
Cream	33-LCCRCZ		
Gray	33-LCGRCZ	600 - 1,000	\$ .94
Gold	33-LCGLCZ		
Green	33-LCGNCZ	1,100 - 1,500	\$ .89
Navy	33-LCNACZ		
Orange	33-LCORCZ	1,600 - 2,400	\$ .84
Pink	33-LCPKCZ		
Purple	33-LCPRCZ	2,500+	\$ .74
Red	33-LCRECZ		
Sky Blue	33-LCSBCZ		
White	33-LCWHCZ		
Yellow	33-LCYECZ		

For imprinting add "PL" to the code + \$0.10

# LENS CLEANERS

## Neon Cloths

84¢  
each



- Variety of radiant colors
- 6" x 7" microfiber
- Packaged 100 to a box

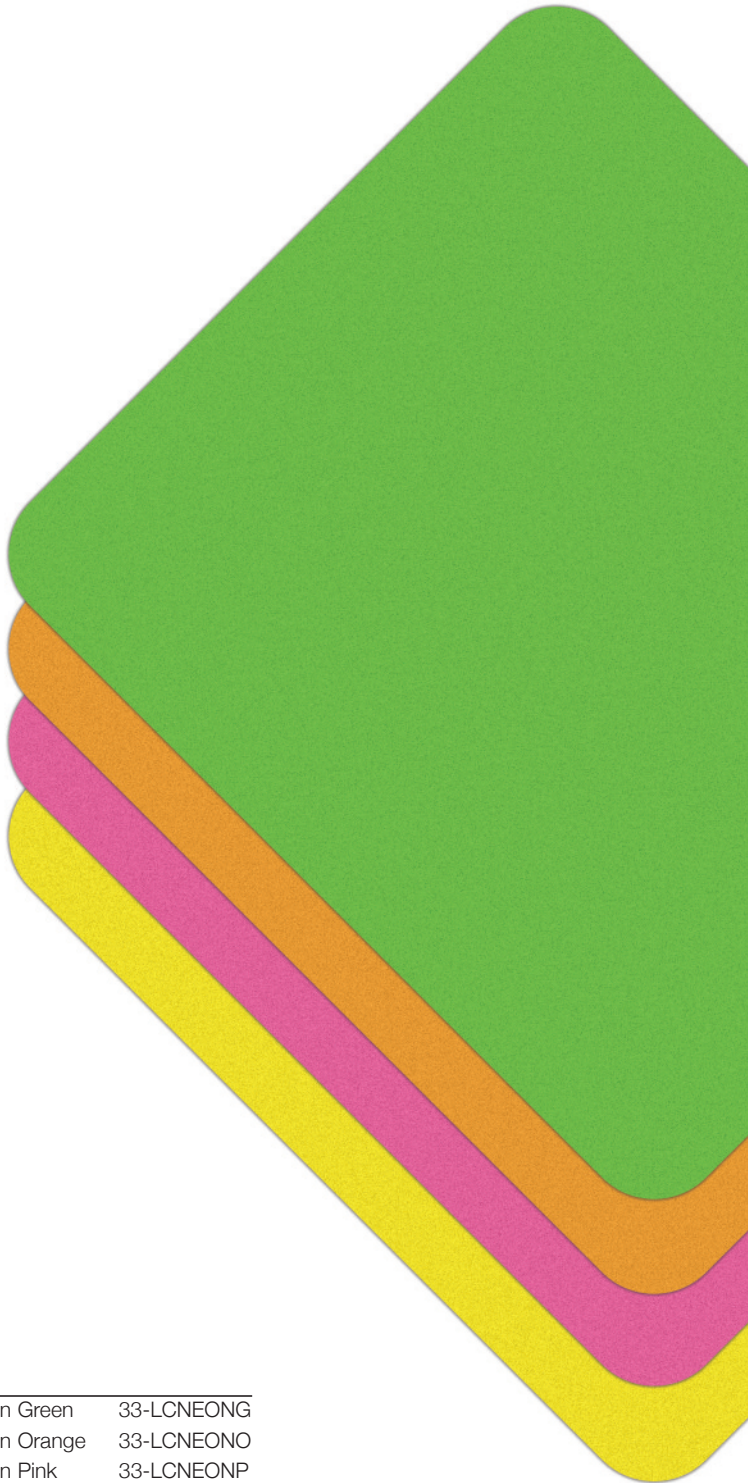

Neon Green	33-LCNEONG
Neon Orange	33-LCNEONO
Neon Pink	33-LCNEONP
Neon Yellow	33-LCNEONY

For imprinting add "PL" to the code + \$0.10

## Wave Cloths

94¢  
each



Fashionable patterns based on our Wave Lens Cleaner label designs.

- Pair with Wave Lens Cleaner (pg.5)
- Each cloth is packed in a clear retail tube
- 6" x 7" microfiber
- Packaged 25 to a bag



Purple Wave	33-D32-25
Orange Wave	33-D31-25
Green Wave	33-D33-25
Blue Wave	33-D30-25

For imprinting add "PL" to the code + \$0.10

# Designer Cloths

94¢  
each



## Variety of Fashionable Patterns

- Each cloth is packed in a clear retail tube
- 6" x 7" microfiber
- Packaged 25 to a box



Liquid Cobalt 33-D09-25



Twilight Orchid 33-D07-25



Honeycomb 33-D08-25



Lotus Flower 33-D06-25



Purple Silk 33-D05-25



Rainbow Madness 33-D03-25



Stained Glass 33-D10-25



Winter Wind 33-D01-25

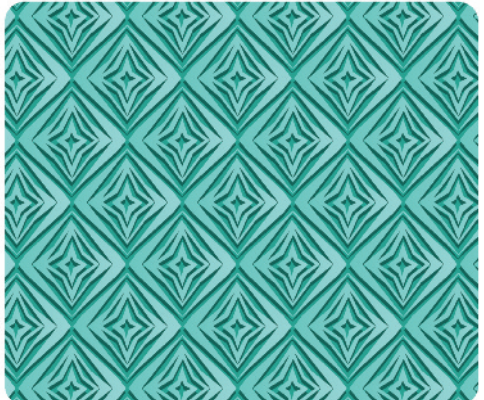

Dancing Diamonds 33-D02-25

LENS CLEANER

CASES

ACCESSORIES

DISPENSING

OPTOMETRIC

SURFACING

FINISHING

TOOLS

FRAME PARTS

# Holiday Cloths

94¢  
each

Spread some holiday cheer in any season! Our festive holiday cloths are a great premium item for your invaluable customers. All designs are available with or without your custom imprinting.

- 6" x 7" silky microfiber
- Minimum order for custom imprinting is 500 cloths per design
- Packed 100 to a box



Merry Christmas (red) 33-LCH12



Season's Greetings 33-LCH10



Merry Christmas (blue) 33-LCH13



Happy Holidays Snowman 33-LCH9



Happy Holidays Wreath 33-LCH16



Season's Greetings Candles 33-LCH19



Merry Christmas Red Ribbon 33-LCH18



Merry Christmas Santa 33-LCH17





Halloween Scarecrow 33-LCH1



Halloween Pumpkin 33-LCH2



July 4th Celebration 33-LCH4



July 4th Balloons 33-LCH3



Thanksgiving Cornucopia 33-LCH6



Breast Cancer Awareness 33-LCH14

## Imprint Sample

All Holiday cloths are available for custom imprinting

\* For imprinting add "PL" to the end of the product code, + \$0.10 (Minimum order 500 cloths). Allow six weeks for processing.



Your Imprint Here

# LENS CLEANERS

## Chamois Cloths

- Thick, heavy-weight cloth
- Flocked texture cleans and absorbs in seconds
- 6" x 7"
- Sold in bag of 100



Loose	33-LCLARZGRL	\$ .99
Cloth-In-Case	33-LCCARZGRL-1	\$ 1.09

## Dispensary Microfiber Cloth

This oversized dispensary microfiber cloth is ideal for use behind the counter and at fitting tables. The sewn in loop allows for hanging on hooks or knobs so the cloth is always within reach. Washable and reusable.

- Large 16 x 16" size
- Sewn in loop for hanging



**\$4.99**  
each



Black	99-331-0302
White	99-331-0301
Gray	99-331-0303

## Lab Size Cloths

**\$3.99**  
each

- Three Materials Available:  
Terry - a looped knit just like terry cloth towels  
Suede - thick flocked material that is very soft and absorbent  
Microfiber - soft and silky fabric
- Large 12" x 15" size



Terry

Suede

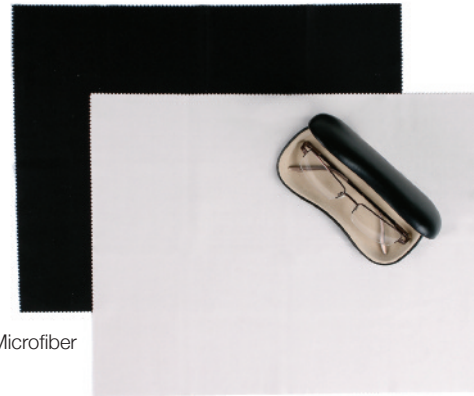

Microfiber

Terry Cloth	33-LCLTTLBLU
Suede Cloth	33-LCLTSLBLU
Black Microfiber Cloth	33-LABCLOTHBLK
Gray Microfiber Cloth	33-LABCLOTHGRAY

## Microfiber Pouches

**\$1.99**  
per pouch

Drawstring Pouches are handmade using our highest quality microfiber. They are a great alternative to hard cases and are perfect for cleaning lenses.

- Double drawstring ensures a tight closure
- Sold in packs of 10



Black	42-OSDSBLKMF
Grey	42-OSDSGRMF
Navy	42-OSDSNAMF
White	42-OSDSWHTMF

# Kimberly-Clark® Disposable Wipes



Kimwipes EX-L 1 ply  
4.4" x 8.4"  
25-34155

Shown in pop-up dispenser box  
25-PUSHUPBOX



Wypall heavy-duty wiper  
12.5" x 16.8"  
25-34015



Kimwipes EX-L 2 ply  
11.8" x 11.8"  
25-34705



Kimwipes EX-L 1 ply  
14.7" x 16.6"  
25-34256



Kaydry EX-L 2 ply  
15" x 16.8"  
25-34721

## By the Case

Kimwipes EX-L 1 Ply	15 Boxes	25-34256C	\$139.99
Kimwipes EX-L 1 Ply	60 Boxes	25-34155C	\$194.99
Kimwipes EX-L 2 Ply	15 Boxes	25-34705C	\$139.99
Kaydry EX-L 2 Ply	15 Boxes	25-34721C	\$189.99

## By the Box

Kimwipes EX-L 1 Ply	140 Wipes	25-34256	\$9.99
Kimwipes EX-L 1 Ply	280 Wipes	25-34155	\$3.99
Kimwipes EX-L 2 Ply	119 Wipes	25-34705	\$9.99
Kaydry EX-L 2 Ply	90 Wipes	25-34721	\$13.99
Wypall X60	180 Wipes	25-34015	\$19.99
Dispenser Box	Each	25-PUSHUPBOX	\$14.99

# Custom Imprinting Services

## Lens Cleaning Cloth Add-On Options

OptiSource offers the largest variety of customization and personalization for lens cleaning cloths. Our services are unique, affordable and easy to use. We require low-quantity minimums and offer quick turnaround times. Our in-house art department works with all file types and can enhance your artwork to maximize printing quality.



### One-Color Printing

Our customers' favorite printing option

Personalize your cloths with your company's information. OptiSource specializes in personalizing any of our cloth offerings with your company's information, logo, marketing message, etc. One color printing is an efficient way to show off your company identity. 1,000 piece minimum.



### Two-Color Printing

Add a custom flair to your cloth printing

If your company logo is two colors, this printing option is a home run! Keep your brand consistent. Pick from any two colors to create a truly custom cloth. 1,000 piece minimum.



### Full Color Printing

Brilliant high resolution printing

We can transfer any photo-quality picture or artwork onto microfiber cloths. Put a picture of your optical storefront, interior, or even your best selling frame on a cloth.

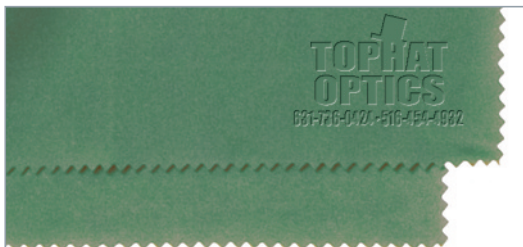

### Embossing

Create a unique look on cloths this year

Our embossing leaves a subtle engraved impression that separates your cloth from the rest! Embossing has an expensive look and feel and can match the look of designer eyeglass case embossing. 1,000 piece minimum.



### Hand-Stitched Edge

Custom stitching adds an elegant look to cloths

Looking for a way to add value and differentiate your cloth from the rest? Stitched edges are hand sewn and add a classy finish to standard cloth edges. 1,000 piece minimum.



### Plastic Carrying Case

Credit-card size carrying case keeps cloths clean and handy

This handy plastic carrying case keeps cloths free of dirt or dust that may collect in glove compartments, drawers, and purses. Perfect size for stashing in pockets and purses or for inserting a business card. 1,000 piece minimum. Printing is done on the cloth, not the case.

# Cases



## Custom Imprinting for Eyeglass Cases

OptiSource offers you the opportunity to add your brand identity to our cases. Include your logo, phone number, address, and website for customers to easily contact you.

Our in-house art department can assist you with production.

Cases – 300 pieces minimum for custom imprinting.

Add \$0.15 for printing

### Pad Printing



### Hot Foil Stamping



### Embossing



1,000 piece minimum order

## Clamshell Cases



### Shiny Leatherette

Small Oval

\$1.09 ea. (100/box)

Assorted 77-010101



### Shiny Leatherette

Large Oval

\$1.29 ea. (50/box)

Assorted 77-030201



### Shiny Leatherette

Medium Rectangular

\$1.09 ea. (100/box)

Assorted 77-020602

# Clamshell Cases

LENS CLEANER

CASES

ACCESSORIES

DISPENSING

OPTOMETRIC

SURFACING

FINISHING

TOOLS

FRAME PARTS



**Shiny Brushed**  
Large Wedge  
\$1.19 ea. (50/box)  
Assorted 77-030301



**Shiny Brushed**  
Medium Oblong  
\$1.19 ea. (100/box)  
Assorted 77-021004



**Shiny Brushed**  
Medium Wave  
\$1.19 ea. (100/box)  
Black 77-020803



**Shiny Brushed**  
Medium Modern  
\$1.09 ea. (100/box)  
Assorted 77-020901  
Black 77-020902



**Shiny Brushed**  
Medium Wave  
\$1.19 ea. (100/box)  
Assorted 77-020804

## Clamshell Cases



**Leatherette**  
Large w/ Finger Lift  
\$1.19 ea. (50/box)  
Assorted 77-030401



**Leatherette**  
Medium Modern  
\$1.19 ea. (100/box)  
Assorted 77-020302

**Leatherette**  
Medium Tapered  
\$1.09 ea. (100/box)  
Assorted 77-020501  
Black 77-020502



**Leatherette**  
Medium Rectangular  
\$1.19 ea. (100/box)  
Assorted 77-020101



**Leatherette**  
Medium Arched  
\$1.19 ea. (100/box)  
Assorted 77-020701



# Clamshell Cases

LENS CLEANER

CASES

ACCESSORIES

DISPENSING

OPTOMETRIC

SURFACING

FINISHING

TOOLS

FRAME PARTS



**Checkered Embossed**  
 Medium Concave  
 \$1.59 ea. (50/box)  
 Assorted 77-020401



**Checkered Embossed**  
 Medium Modern  
 \$1.49 ea. (50/box)  
 Assorted 77-020301



**Leatherette**  
 Medium Convex  
 \$1.29 ea. (100/box)  
 Assorted 77-020203  
 Black 77-020204



**Denim**  
 Medium Rectangular  
 \$1.19 ea. (100/box)  
 Assorted 77-020102



**Retro Circle**  
 Small Modern  
 \$1.59 ea. (50/box)  
 Assorted 77-010201

## Clamshell Cases



Suede  
Small Rectangular  
\$1.29 ea. (50/box)  
Assorted 77-020601



Suede  
Medium Box  
\$1.59 ea. (50/box)  
Assorted 77-030101



Bright Leatherette  
Medium Convex  
\$1.19 ea. (100/box)  
Assorted 77-020201



Speckled  
Medium Convex  
\$1.39 ea. (50/box)  
Assorted 77-020202



Speckled  
Small Modern  
\$1.29 ea. (50/box)  
Assorted 77-010202

# Clamshell Cases



**Shiny Diamond**  
Medium Oblong

\$1.29 ea. (50/box)  
Assorted 77-021002



**Shiny Diamond**  
Medium Wave

\$1.39 ea. (50/box)  
Assorted 77-020802



**Mini Diamond**  
Medium Oblong

\$1.29 ea. (50/box)  
Assorted 77-021003



**Mini Diamond**  
Medium Wave

\$1.39 ea. (50/box)  
Black 77-020801



**Micro Diamond**  
Large Oval

\$1.49 ea. (50/box)  
Assorted 77-030202



**Micro Diamond**  
Medium Slender

\$1.29 ea. (50/box)  
Assorted 77-020503

# Sunglass Cases

50 per case



**Leatherette**

Sunglass XL  
\$1.69 ea.

Assorted 77-040301  
Black 77-040202

**Two-Tone & Black**

Sunglass Oval

\$1.99 ea.

Assorted 77-040201



**Checkered**

Sunglass Rectangular

\$1.89 ea.

Assorted 77-040101



# Semi-Hard Cases

100 per case



**Traditional Paisley**

Small

\$1.49 ea.

Assorted 84-0705



**Traditional Paisley**

Medium

\$1.59 ea.

Assorted 84-0606



**Traditional Paisley**

Large

\$1.69 ea.

Assorted 84-0805



**Leatherette**

Small

\$1.49 ea.

Assorted 84-0701



**Leatherette**

Medium

\$1.59 ea.

Assorted 84-0601



**Leatherette**

Large

\$1.69 ea.

Assorted 84-0801

# Semi-Hard Cases

100 per case

## Leopard

Small

\$1.49 ea.

84-0704



## Leopard

Medium

\$1.59 ea.

84-0605



## Leopard

Large

\$1.69 ea.

84-0804



## Black Leatherette

Small

\$1.49 ea.

84-0702



## Black Leatherette

Medium

\$1.59 ea.

84-0602



## Black Leatherette

Large

\$1.69 ea.

84-0802



## Brown Leatherette

Small

\$1.49 ea.

84-0703



## Brown Leatherette

Medium

\$1.59 ea.

84-0603



## Brown Leatherette

Large

\$1.69 ea.

84-0803



## Caramel Leatherette

Medium

\$1.59 ea.

84-0604



## Fun Fabric

Medium

\$1.59 ea.

Assorted 84-0608



## Gel Touch

Medium

\$1.59 ea.

Assorted 84-0607



# Soft Slip-In Cases

100 per case



**Petals**  
\$0.79 ea.  
Assorted 84-0109



**Flowers**  
\$0.79 ea.  
Assorted 84-0103



**Floral**  
\$0.79 ea.  
Assorted 84-0102



**Fun Fabric**  
Half Eye  
\$0.69 ea.  
Assorted 84-0302



**Fun Fabric**  
Medium  
\$0.79 ea.  
Assorted 84-0104



**Dots**  
Half-Eye  
\$0.59 ea.  
Assorted 84-0303



**Dots**  
Medium  
\$0.69 ea.  
Assorted 84-0101

# Soft Slip-In Cases

100 per case



**Textured Modern**  
\$1.19 ea.  
Assorted 84-0108



**Gel touch**  
\$0.79 ea.  
Assorted 84-0110



**Leatherette**  
\$0.69 ea.  
Assorted 84-0111



**Leatherette w/Clip**  
\$0.79 ea.  
Assorted 84-0113  
Black 84-0114  
Brown 84-0115



**Leatherette Half-Eye**  
\$0.59 ea.  
Assorted 84-0301



**Leatherette Flip-Top w/Clip**  
\$1.39 ea.  
Assorted 84-0501



**Leatherette Flip-Top**  
\$1.19 ea.  
Assorted 84-0401  
Black 84-0402  
Brown 84-0403

## Soft Slip-In Cases

100 per case



Diamonds

\$0.69 ea.  
Assorted 84-0105



Animals

\$0.69 ea.  
Assorted 84-0112



Traditional Paisley

\$0.79 ea.  
Assorted 84-0107



New Paisley

\$0.79 ea.  
Assorted 84-0106

## Soft-Flip Top Cases

100 per case



Traditional Paisley

Flip-Top  
\$0.79 ea.  
Assorted 84-0203



Petals

Flip-Top  
\$0.79 ea.  
Assorted 84-0201



Diamonds

Flip-Top  
\$0.79 ea.  
Assorted 84-0202



# Accessories





OptiPets are the creative, collectible, and fun-to-use eyeglass holder. Each hand-painted piece has a cradle designed to hold folded frame temples.

Originally introduced to spice up storefronts and frame counters, OptiPets have quickly become an incredibly popular accessory item that sells itself. OptiPets have become the go-to gift item for the hardest to shop for men, women, and children.

- Perfect for nightstands, desks, kitchen counters, and end tables
- Patients will always know exactly where their glasses are

## Animal Collections

Our animal collections are a staple item for children's frame displays, pediatric dispensaries, and collectors of all things animals.



### Animals

- 6 piece set

18-FG-AN

\$47.99



### Dinosaurs

- 6 piece set

18-E15513

\$35.99

**NEW  
PRODUCT**



## Children's Animals

• 12 piece set

18-E15019      \$71.99

# Breed Specific Collection

\$14.99  
each

These United Kingdom born original designs are heavy-weight, hand-painted, and have a high-shine glazed finish. These adorable versions of popular breeds are the crown jewel of the OptiPets product line. They uniquely dress up any décor and are a must-have for your pet loving patients.



German Shepherd	18-E15511
Chihuahua	18-E15555
Beagle	18-E15559
Black Poodle	18-E15558
Westie	18-E15512
Dachshund	18-E15556

German Shepherd, Chihuahua, Beagle, Black Poodle, Westie, Dachshund



Red Setter	18-E15800
St. Bernard	18-E15562
Shih-Tzu	18-E15485
Dalmatian	18-E15563
Black Pug	18-E15560
Tan Pug	18-E42031

Red Setter, St. Bernard, Shihtzu, Dalmatian, Black Pug, Tan Pug



\$14.99  
each

Pekingese	18-E40006
Labrador	18-E15561
Rottweiler	18-E40011
Basset Hound	18-E40000
CKC Spaniel	18-E40001

Pekingese, Labrador, Rottweiler, Basset Hound, CKC Spaniel



Black Labrador	18-E42025
Chocolate Labrador	18-E42021
Boxer	18-E42023
Yorkie	18-E42026

Black Labrador, Chocolate Labrador, Boxer, Yorkie

Breed Specific Collection

\$14.99  
each



White Poodle, Springer Spaniel, English Bulldog

White Poodle	18-E42024
Springer Spaniel	18-E42022
English Bulldog	18-E42027



Comet, Siamese, Nuky

Comet Cat	18-E42030
Siamese Cat	18-E42028
Nuky Cat	18-E42029
Tigger Cat	18-E40007
Jess Cat	18-E40005
Sheba Cat	18-E40010
Meerkat	18-E15557



Tigger, Jess, Sheba

Meerkat

## Fish and Frogs

The six-piece Art Fish collection features intricate hand paint work that contrasts frame colors. Our Frogs have won the hearts of ECPs and patients around the world. And of course, who could forget the beloved Ugly Fish? These bug-eyed creations are a conversation piece and hold frames with their temples open.



### Ugly Fish

• 3 piece set

18-E15700

\$29.99



### Art Fish

• 6 piece set

18-FG-FS

\$53.99



### Frogs

• 6 piece set

18-A10600

\$53.99



Amusingly Cute Eyewear Holders



Walnut

Natural

Cedar

## Specialty Noses

Our specialty nose collections offer a design for every taste. We are proud to offer the largest collection of eyewear holders and continuously add to the range. Our hand-painted designs range from elegant florals to bling-studded lip-noses.



## Wood Noses

• 6 piece set

18-345-2	Walnut	\$53.99
18-345-3	Natural	\$53.99
18-345-1	Cedar	\$53.99

## Tupton Noses

• 6 piece set

18-TUPTON	\$64.99
-----------	---------



## Lip Noses

• 12 piece set

18-FG-PLN	\$65.99
-----------	---------





## Chrome Noses

• 2 piece set

18-FG-CHM2 \$15.99



## Glass Noses

• 6 piece set

18-GLASS \$89.99



## Abstract Noses

• 12 piece set

18-FG-AB \$65.99



## Bling Noses

• 6 piece set

18-FG-BLN \$53.99



## Butterfly Noses

• 6 piece set

18-FG-BBN \$53.99



## Sea Coral Noses

• 6 piece set

18-FG-SC \$47.99



Baseball	18-FG-B
Basketball	18-FG-BB
Football	18-FG-FB
Male Golf	18-FG-G
Female Golf Blue	18-FG-GBLUE
Female Golf Pink	18-FG-GPINK
Ice Hockey	18-FG-H
Soccer	18-FG-SB
Tennis	18-FG-T

## Sports Noses

**\$7.99**  
each

Looking for an imaginative way to display your new sports frame line? How about the perfect gift for the family athlete, Mother's Day, Father's Day, or stocking stuffer? Our sports noses are a top-selling part of the OptiNoses line thanks to their original creative design and character.

# Specialty Reading Glasses Collections

## MiCRO SPEX



\$12.50  
each

### Premium Folding Reading Glasses

The patented design technology allows the glasses to easily fold into the size of a Zippo® lighter and fit inside a stylish, durable hard case.

- Patented telescoping temples
- Resilient spring hinges
- Comfortable built-in nose pads
- Micro-size case



### Frame Colors



Brown

Black

Gunmetal

### How to Order

1. Build item number beginning with 26-
2. Add color code
3. Add power code

Color Codes  
Brown: 10, Black: 11, Gunmetal: 12

Power Codes  
150, 200, 250, 300

### Sample Product Code

Note: All product codes start with 26-

26- 11 150

Item # Color Code Power



Display holds 24 readers

26-10000

\$29.99

Readers not included



# SLIM SPEX



Folds Thin as a Paperclip 

Patented revolutionary hardware allows full-size frames to magically fold flat inside a super slim case. Discretely slips into pockets and purses for easy carrying.



Display holds 6 readers

Readers not included

99-363-01

\$29.99

Display free with purchase of 24 Slim Spex readers

### How to Order

1. Build item number beginning with 26-
2. Add color code from under product photo.
3. Add power code: 100, 150, 200, 250

### Sample Product Code

Note: All product codes start with 26-

26-	22	200
Item #	Color	Power

## Readers

\$16.99 each

- Comfort fit with spring hinges
- Premium metal frames
- Optical quality lenses



Shiny Gold: 20

Matte Black: 22

Gunmetal: 21

## Ophthalmic (Rx-able)

\$32.50 each

- Functioning rim locks, fully Rx-able
- Stainless steel frames with premium edge pattern
- Premium nose pads and temple ends
- Unisex full-size frame makes a perfect fit for any face



Antique Bronze: 26-301

Matte Black: 26-302

Gunmetal: 26-303

ACCESSORIES

# Pod Readers

**\$9.99**  
each

## The All-In-One Reader with Built-In Case

The amazing Pod Readers' swivel temples create a stylish design that also doubles as a protective case.



## Display

Includes 30 assorted readers

13-1000 \$229.99



Sky Blue (1)



Mocha Brown (2)



Cool Gray (3)



Plum Purple (4)



Soft Red (5)



Sunrise Yellow (6)

### How to Order

1. Build item number beginning with 13-
2. Add color code.
3. Add power code.

Power Codes  
100, 150, 200, 250, 300

### Sample Product Code

Note: All product codes start with 13-

**13- 1 150**

Item #    Color Code    Power

# Blade Readers

Patented Pocket Blade Readers feature swivel temples that create a durable case. Small and lightweight, the Pocket Blade is the ideal reader for people on the go.

**\$8.99**  
each



Lime (1)



Plum (2)



Black (3)



Ice (4)



Red (5)



Blue (6)



Readers not included

### How to Order

1. Build item number beginning with 99-276-
2. Add color code. See above.
3. Add power code.

Power Codes  
100, 150, 200, 250, 300

### Sample Product Code

Note: All product codes start with 99-276-

**99-276- 1 150**

Item #    Color Code    Power

## Display

Trendy display highlights the key features of the Pocket Blade and holds 8 pieces.

99-276-1000

\$36.99



\$5.99  
each

### The Latest Trend in Novelty Readers

Cleverly designed readers with memory-plastic temples that gently and securely hang around the neck when not in use.

- Three fashionable styles to choose from
- Unique temple design ensures that you are never without your readers
- Available powers: 1.00, 1.25, 1.50, 1.75, 2.00, 2.50, 3.00



Style shown is Ultra in blue

#### Oval (style code 1)



Black (color code 1)



Brown/Orange (color code 2)



Red (color code 3)



Blue (color code 4)

#### Rectangle (style code 2)



Black (color code 1)



Blue (color code 2)



Brown (color code 3)

#### Ultra (style code 3)



Black (color code 1)



Blue (color code 2)



Brown (color code 3)

#### How to Order

1. Build item number beginning with 20-242-
2. Add style code from above.
3. Add color code from above.
4. Add power code.

Power Codes  
100, 125, 150, 175, 200, 250, 300

#### Sample Product Code

Note: All product codes start with **20-242-**

20-242-	1	1	150
Item #	Style Code	Color Code	Power Code



Empty Display

20-242-999 \$29.99

# Standard Reading Glasses Collections

## Preferred Collection

Preferred readers offer high style without the high price. These mid-level readers offer better-than-drugstore style at comparable prices, and include a matching soft case. With the assistance of an optical professional to find the best power, style, and fit, your customers will never shop elsewhere for readers.

**\$4.99**  
each

### How to Order

1. Build item number beginning with 96-
2. Add two-digit style code
3. Add two-digit color code
4. Add power code: 150, 200, or 250

### Sample Product Code

Note: All product codes start with 96-

96-1101150

Item #	Style Code	Color Code	Power Code
96	11	01	150

### Reader Dimensions

1. Frame Width
2. Lens Width
3. Lens Depth
4. Temple Length

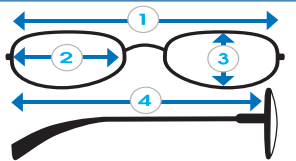

## Illusion

Style code: 01

Frame Width	135
Lens Width	52
Lens Depth	25
Temple Length	136



## Fantasia

Style code: 02

Frame Width	137
Lens Width	52.6
Lens Depth	31.8
Temple Length	142





Preferred Collection

\$4.99  
each

Daydream

Style code: 03

Frame Width 136  
Lens Width 49.7  
Lens Depth 24  
Temple Length 139



Color code: 55



Color code: 11



Color code: 66

Visionaire

Style code: 04

Frame Width 140  
Lens Width 50  
Lens Depth 35  
Temple Length 147



Color code: 54



Color code: 89



Color code: 87

Kurios

Style code: 05

Frame Width 138  
Lens Width 50.5  
Lens Depth 34  
Temple Length 147



Color code: 87



Color code: 73



Color code: 89

LENS CLEANER

CASES

ACCESSORIES

DISPENSING

OPTOMETRIC

SURFACING

FINISHING

TOOLS

FRAME PARTS

Preferred Collection

\$4.99  
each

Persian

Style code: 06

Frame Width 138  
Lens Width 49  
Lens Depth 26  
Temple Length 145



Color code: 13



Color code: 63



Color code: 43

Intrigue

Style code: 07

Frame Width 128  
Lens Width 49.5  
Lens Depth 28  
Temple Length 142



Color code: 74



Color code: 71



Color code: 81

Ezy

Style code: 08

Frame Width 137  
Lens Width 52.5  
Lens Depth 34.5  
Temple Length 141



Color code: 55



Color code: 87



Color code: 11

Preferred Collection

\$4.99  
each

Virtuoso

Frame Width 135  
Lens Width 45  
Lens Depth 37  
Temple Length 145

Style code: 09



Color code: 74



Color code: 11



Color code: 23

London

Frame Width 140  
Lens Width 54.5  
Lens Depth 27  
Temple Length 141

Style code: 10



Color code: 81



Color code: 83



Color code: 89

Nikito

Frame Width 134  
Lens Width 47  
Lens Depth 38.6  
Temple Length 141

Style code: 11



Color code: 17



Color code: 53



Color code: 78

LENS CLEANER

CASES

ACCESSORIES

DISPENSING

OPTOMETRIC

SURFACING

FINISHING

TOOLS

FRAME PARTS

Preferred Collection

\$4.99  
each

Carter

Style code: 12

Frame Width	135
Lens Width	51
Lens Depth	37
Temple Length	141



Color code: 87



Color code: 57



Color code: 89

Concerto

Style code: 13

Frame Width	130
Lens Width	49
Lens Depth	27.6
Temple Length	134



Color code: 11

All Concerto readers come with a clear plastic case



Color code: 88



Color code: 55

Glamour

Style code: 14

Frame Width	134
Lens Width	52
Lens Depth	27
Temple Length	137



Color code: 83



Color code: 11



Color code: 85



All readers on this page come with a black-stitched black soft case

\$4.99 each

Preferred Collection

Crusade

Style code: 15

Frame Width	135
Lens Width	51
Lens Depth	37
Temple Length	141



Color code: 88

Color code: 11

Carnegie

Style code: 18

Frame Width	136
Lens Width	52
Lens Depth	29
Temple Length	141



Color code: 89

Color code: 77

Botero

Style code: 16

Frame Width	133
Lens Width	54
Lens Depth	28.5
Temple Length	145



Color code: 88

Color code: 77

Daly

Style code: 19

Frame Width	136
Lens Width	52
Lens Depth	30
Temple Length	135



Color code: 77

Color code: 88

Zara

Style code: 17

Frame Width	124
Lens Width	51
Lens Depth	26.4
Temple Length	135



Color code: 89

Color code: 19

Alejandro

Style code: 20

Frame Width	135
Lens Width	50
Lens Depth	27
Temple Length	132



Color code: 77

Color code: 88

# ACCESSORIES

## Elite Collection

**\$9.99**  
each

Elite readers are our highest quality reading glasses. These ophthalmic quality frames include both timeless designs and today's best-selling styles, and are made with premium materials: acetate, titanium, and natural wood. Each piece is hand-made to the highest standards and includes a premium case.



All Elite readers come with a stylish black hard case with magnetic cover

### Chic (acetate)

Frame Width 139  
Lens Width 54  
Lens Depth 28  
Temple Length 140

Style code: 21



Color code: 86

Color code: 66

### Jackie J. (acetate)

Frame Width 136  
Lens Width 53  
Lens Depth 37  
Temple Length 145

Style code: 24



Color code: 64

Color code: 63

### Monaco (acetate)

Frame Width 136  
Lens Width 53  
Lens Depth 31  
Temple Length 145

Style code: 22



Color code: 51

Color code: 65

### Alva E. (titanium)

Frame Width 129  
Lens Width 52  
Lens Depth 29.8  
Temple Length 140

Style code: 25



Color code: 88

Color code: 77

### Falkao (acetate)

Frame Width 138  
Lens Width 53  
Lens Depth 33  
Temple Length 140

Style code: 23



Color code: 55

Color code: 87

### Soho (acetate/wood)

Frame Width 140  
Lens Width 54  
Lens Depth 39  
Temple Length 140

Style code: 26



Color code: 77

Color code: 87

# Ultimate Collection

**\$9.99**  
each

The Rx-able frames in this collection are constructed of Ultimate™, a breakthrough material that is ultra-feather-light, ultra-flexible, and virtually indestructible.

**How to Order**

1. Build item number beginning with 96-
2. Add two-digit style code
3. Add two-digit color code
4. Add power code: 150, 200, or 250

**Sample Product Code**  
Note: All product codes start with 96-

96-	11	01	150
Item #	Style Code	Color Code	Power

**Miss**

Frame Width	140
Lens Width	53
Lens Depth	30
Temple Length	140

Style code: 33



Color code: 55



Color code: 81



Color code: 66

**Max**

Frame Width	137
Lens Width	52
Lens Depth	34
Temple Length	140

Style code: 34



Color code: 88



Color code: 89



Color code: 77

**Min**

Frame Width	134.5
Lens Width	52
Lens Depth	29
Temple Length	140

Style code: 35



Color code: 88



Color code: 55



Color code: 77

## Basic Collection

**\$2.99**  
each

Basic Readers are for the value-conscious consumer. These single piece injection molded frames offer simple styling at a value price and include a basic case.

### How to Order

1. Build item number beginning with 96-
2. Add two-digit style code
3. Add two-digit color code
4. Add power code: 150, 200, or 250

### Sample Product Code

Note: All product codes start with 96-

**96-1101150**

96-	11	01	150
Item #	Style Code	Color Code	Power Code

## Cheers

Frame Width 134  
Lens Width 45.5  
Lens Depth 18  
Temple Length 134

Style code: 27



## Cassandra

Frame Width 136  
Lens Width 50  
Lens Depth 23.7  
Temple Length 150

Style code: 28



## Tavio

Frame Width 134  
Lens Width 46.5  
Lens Depth 23  
Temple Length 142

Style code: 29





Basic Collection

\$2.99  
each

Charlotte

Style code: 30

Frame Width 134.5  
Lens Width 50  
Lens Depth 27  
Temple Length 140



Color code: 19



Color code: 98

Charlotte and Tokyo readers come with a clear tube hard case

Tokyo

Style code: 31

Frame Width 129  
Lens Width 52  
Lens Depth 29.8  
Temple Length 140



Color code: 88



Color code: 55



Mozil

Style code: 32

Frame Width 120  
Lens Width 45  
Lens Depth 23  
Temple Length 138



Color code: 88



Color code: 64





# CLiC<sup>®</sup>

## magnetic readers



The patented design features a neodymium magnetic front connection and a built-in adjustable retainer that allows the reading glasses to be conveniently worn around the neck when not in use. They're available in a wide range of styles and colors with powers ranging from +1.25 to +3.00.

- Patented magnetic front connection technology with built-in adjustable retainer
- Rx-able
- Virtually unbreakable
- Frames fold at the hinge to stay out of the way when not in use
- Available Powers: 1.50, 1.75, 2.00, 2.50, 3.00; select styles in 1.25 and 2.25

### T-Bar Display

47-CLICTBAR      \$24.99

Readers not included

OptiSource is the Exclusive Optical Distributor of CLiC<sup>®</sup> Reading Glasses

Original

Style code: 07

\$16.99  
each

Frame Width	140
Lens Width	50
Lens Depth	27
Nose Bridge	16
Temple Length	190-209



Blue: 04  
Also available in +1.25 and +2.25



Black: 01  
Also available in +1.25 and +2.25



Tortoise: 02  
Also available in +1.25 and +2.25



Bordeaux: 05



Clear: 06  
Also available in +1.25 and +2.25



Emerald: 07



Lavender: 08



Red: 10  
Also available in +1.25 and +2.25



Lemon Lime: 18

Original XXL

Style code: 08

\$18.99 each

Frame Width	143
Lens Width	50
Lens Depth	27
Nose Bridge	16
Temple Length	190-209



Bordeaux: 05



Black: 01  
Also available in +1.25 and +2.25



Tortoise: 02  
Also available in +2.25



Blue: 04



Blue Jean: 03



Clear: 06



Red: 10

Reader Dimensions (mm)

1. Frame Width
2. Lens Width
3. Lens Depth
4. Nose Bridge
5. Temple Length

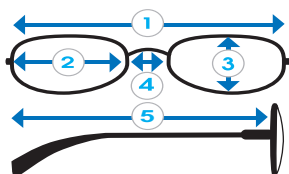

How to Order

1. Build item number beginning with 47-
  2. Add style code from under collection name.
  3. Add color code from under product photo.
  4. Add power code.
- Powers: 1.25\*, 1.50, 1.75, 2.00, 2.25\*, 2.50, 3.00  
\*Available in selected styles

Sample Product Code

Note: All product codes start with 47-

47-	01	18	150
Item #	Style Code	Color Code	Power

## Executive

Style code: 05

\$18.99  
each

Frame Width	142
Lens Width	54
Lens Depth	30
Nose Bridge	14
Temple Length	190-209



Black: 01  
Also available in +2.25



Tortoise: 02  
Also available in +2.25



Blue Jean: 03



Red: 10

## Half Frames

Style code: 12

\$29.99  
each

Frame Width	140
Lens Width	53
Lens Depth	26
Nose Bridge	16
Temple Length	190-209



Black: 01



## Sonoma Tortoise

Style code: 13

\$29.99  
each

Frame Width	140
Lens Width	54
Lens Depth	26
Nose Bridge	16
Temple Length	190-209



Tortoise: 02



ACCESSORIES

City

Style code: 02

\$16.99  
each

Frame Width	140
Lens Width	51
Lens Depth	23
Nose Bridge	13
Temple Length	190-209



Black: 01



Blue Jean: 03



Blue: 04



Bordeaux: 05



Clear: 06



Emerald: 07



Lavender: 08



Pink: 09



Red: 10



White: 11

# City XXL

Style code: 03

**\$18.99**  
each

Frame Width	143
Lens Width	51
Lens Depth	23
Nose Bridge	13
Temple Length	190-209



Black: 01



Tortoise: 02



Clear: 06

# Vintage

Style code: 10

**\$16.99**  
each

Frame Width	132
Lens Width	44
Lens Depth	35
Nose Bridge	16
Temple Length	190-209



Black: 01



Tortoise: 02

# Vintage XXL

Style code: 11

**\$18.99**  
each

Frame Width	135
Lens Width	40
Lens Depth	45
Nose Bridge	13
Temple Length	190-209



Tortoise: 02



Black: 01

ACCESSORIES

Ashbury

Style code: 01

\$19.99  
each

Frame Width	140
Lens Width	51
Lens Depth	37
Nose Bridge	15
Temple Length	190-209



Black: 01



Tortoise: 02

CliC Prepacks

Our Top Sellers Bundled for Your Convenience

12-Piece Prepack

47-CLIC12-AST

\$210.00



Original Blue

+1.50  
+2.50



Original Black

+1.50  
+2.50



Executive Blue Jean

+1.50  
+2.00



Original Clear

+2.00  
+2.50



Original XXL Black

+1.50  
+2.00



Original XXL Tortoise

+2.00  
+2.50

18-Piece Prepack

47-CLIC18-AST

\$317.00



Original Blue

+1.50  
+2.50



Original Black

+1.50  
+2.50



Executive Blue Jean

+1.50  
+2.50



Original Clear

+2.00  
+2.50



Original XXL Black

+2.00  
+2.50



Original XXL Tortoise

+2.00  
+2.50



Executive Black

+2.00  
+2.50



Executive Tortoise

+1.50  
+3.00



City Clear

+1.50  
+3.00



Ages 0-3



99-328-130703 Little Lilac



99-328-130603 Black Satin



99-328-130203 Powder Pink



99-328-130103 Baby Blue

Ages 3-7+



99-328-130937 Grape Jelly



99-328-130837 Red Hot



99-328-130437 Hot Pink



99-328-130337 Electric Blue



99-328-130537 Jet Black



**minishades™**  
Polarized

**NEW PRODUCT**



**\$10.00**  
each

- Rx-able, polarized, 100% UV protection, and impact resistant
- Fits children ages 0-7+
- Proprietary rubber frame material is virtually indestructible and super comfy

**“Hide n’ Seek” Loss & Damage Warranty**

At any point in the future, should your patient’s child lose or damage their MiniShades, or scratch the lenses, the manufacturer will send them a one-time replacement pair for free.

**22-Piece Display**

**\$219.99**

Wire frame display includes a pre-assorted mix of 20 MiniShades plus 2 extra units for try-on.



99-328-MS701  
10"W x 12"D x 12"H

# Ultra Thin Clip-On Sunglasses

**\$14.99**  
per clip

Free Case with Every Clip



## Ultra Thin Clip-On Sunglasses

Made of .7mm Tri Acetate Cellulose (TAC) polarized lenses.

### Frameless Design Technology

- Rimless style provides a barely-there look and feel
- Ever-Crimp hooks use no screws or rivets
- Adjustable nose bridge and hooks provide a near-custom fit



POP display



Complete fitting kit includes  
43 clip-ons in three boxes

### How to Order

1. Build item number beginning with 49-  
(See fitting guide pages for both shape code and shape size availability.)
2. Add shape number.
3. Add shape size.
4. Add lens color code.  
Gray (color code 1)  
Brown (color code 2)

### Sample Product Code

Note: All product codes start with 49-

49-	10	52	1
	Shape	Size(mm)	Color

POP Display	49-2991-1	\$29.99
43 Piece Fitting Kit	49-3000	\$499.99
Empty Fitting Box	49-2000	\$29.99

# Ultra Thin Clip-On Sunglasses Actual Size Fitting Guide

Place frames over the best-fitting colored shape

**DRX**  
Shape 10

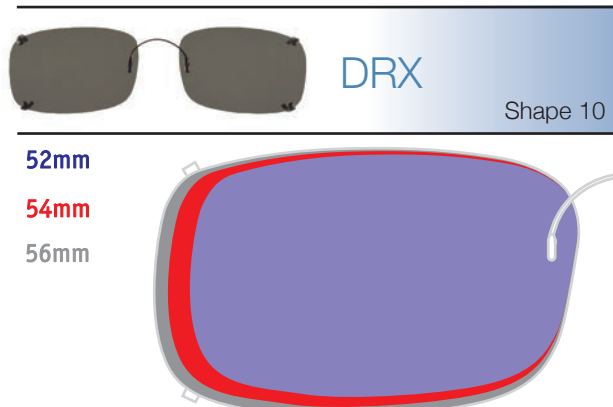

52mm  
54mm  
56mm

**EXX**  
Shape 11

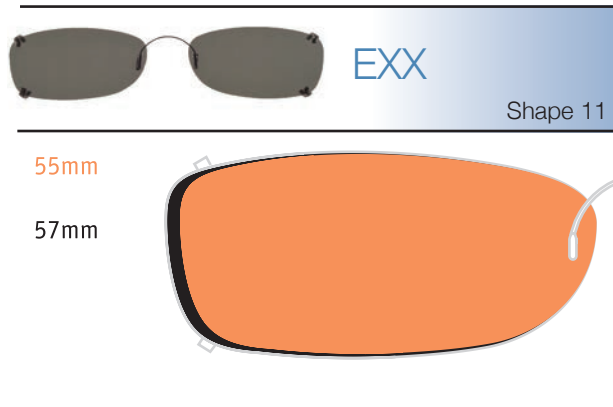

55mm  
57mm

**Modified Oval**  
Shape 12

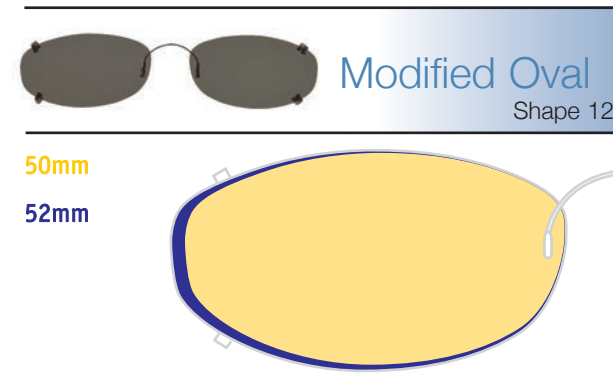

50mm  
52mm

**MDX**  
Shape 13

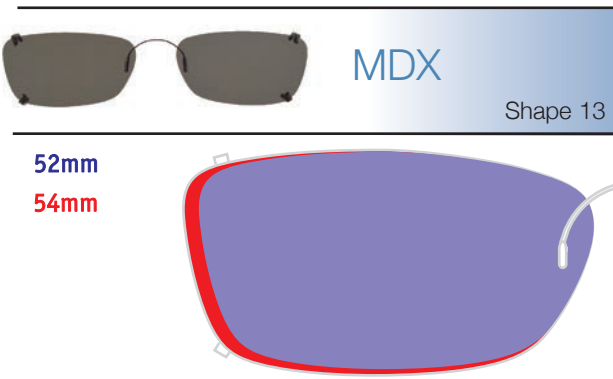

52mm  
54mm

**Modified Rectangle**  
Shape 14

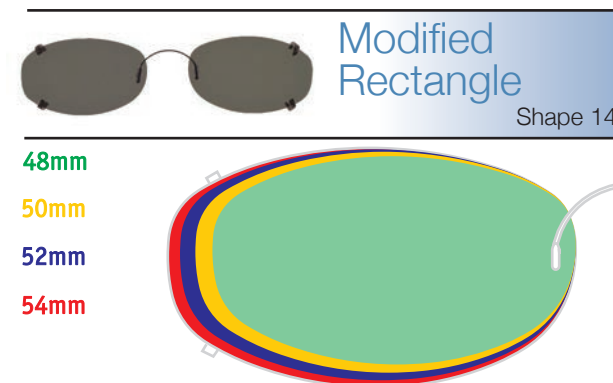

48mm  
50mm  
52mm  
54mm

**Oval**  
Shape 15

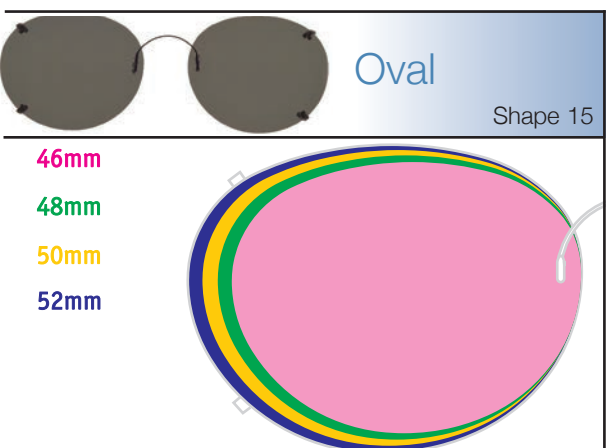

46mm  
48mm  
50mm  
52mm

# Ultra Thin Clip-On Sunglasses Actual Size Fitting Guide

Place frames over the best-fitting colored shape

**Rectangle**  
Shape 16

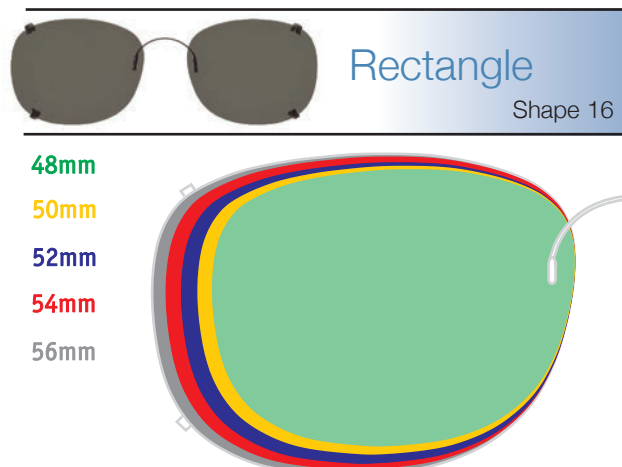

48mm  
50mm  
52mm  
54mm  
56mm

**Slim Rectangle**  
Shape 17

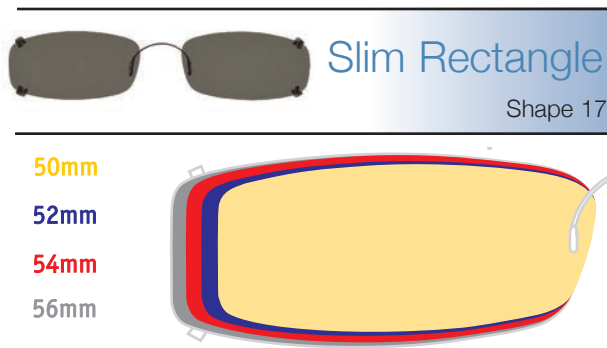

50mm  
52mm  
54mm  
56mm

**SLX**  
Shape 18

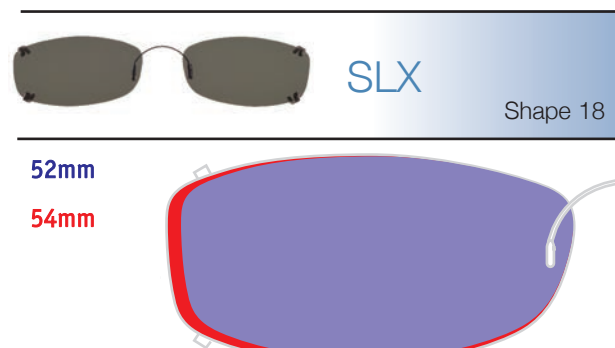

52mm  
54mm

**Square**  
Shape 19

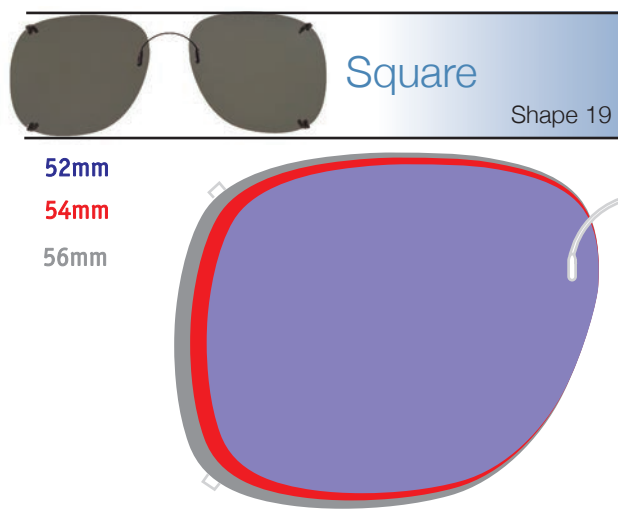

52mm  
54mm  
56mm

**Tru-Rectangle**  
Shape 20

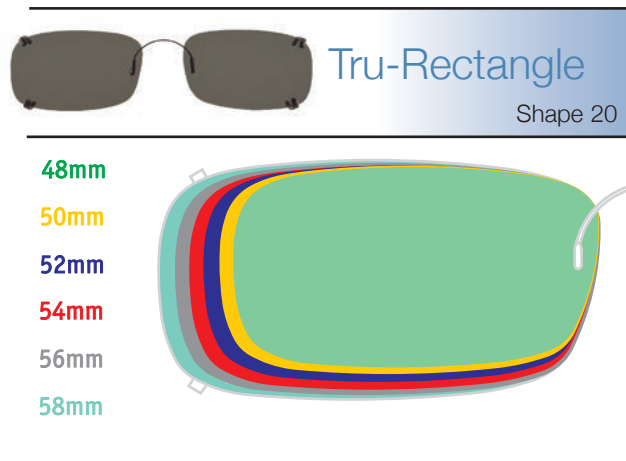

48mm  
50mm  
52mm  
54mm  
56mm  
58mm

**Lo-Rectangle**  
Shape 21

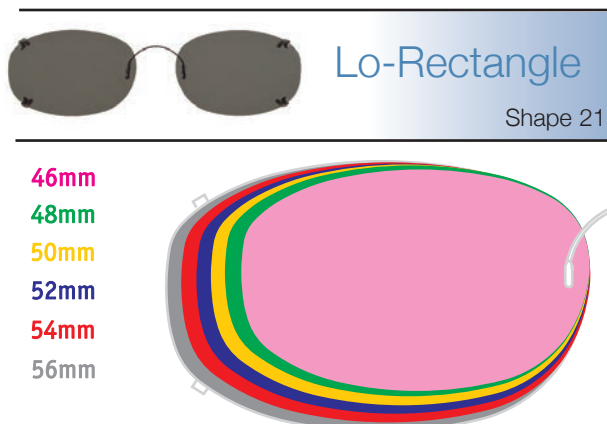

46mm  
48mm  
50mm  
52mm  
54mm  
56mm



# D-Clips® Clip-Ons

**\$6.99**  
per clip













Metal Alloy Clip Construction

Free Case  
with Every Clip

The D-Clips line features the DDO Flip-Clip, a patented, virtually unbreakable clip mechanism. The clip mechanism has a proprietary coating to protect ophthalmic lenses and prevent shifting and scratching lenses.

- Convenient one hand application to Rx frames
- Designed to ensure that the polarized horizontal axis is never compromised
- Polarized shatter resistant lenses



 Deep Rectangle Size: 54 x 31 Shape C1	 Narrow Rectangle Size: 52 x 31 Shape C2	 Tru Rectangle Size: 53 x 29 Shape TRUX
 Small Aviator Size: 54 x 48 Shape H1	 Large Aviator Size: 60 x 51 Shape H2	 Lo Rectangle Size: 56 x 31 Shape XLO
 Small Oval Size: 50 x 37 Shape V1	 Oval Size: 54 x 38 Shape V2	 Rectangle Size: 58 x 47 Shape 5
 Small Rectangle Size: 47 x 33 Shape X1	 Medium Rectangle Size: 52 x 35 Shape X2	 Large Rectangle Size: 62 x 39 Shape X3

## How to Order

1. Build item number beginning with 67-FLIP  
(See fitting guide pages for both shape code and shape size availability.)
2. Add shape number from above.
3. Add lens color code.  
Gray (color code GR)  
Brown (color code BR)

### Sample Product Code

Note: All product codes start with **67-FLIP**

**67-FLIP** **C1** **GR**  
 Shape      Color

### Clip Colors:

Black Clip / Gray Lens  
 or Bronze Clip / Brown Lens

### Lens Colors:

Gray or Brown Polarized



# Shade Control® Clip-Ons

**\$20.99**  
per clip

Free Case with Every Clip

Premium Quality Stainless Steel Frames  
with Patented Concealed Spring Top-Bar

Shade control polarized clip-ons will fit 96% of optical frames.  
The concealed spring keeps the clip at a perfect horizontal axis.  
The upscale fitting kit is ideal for presentation, fitting, and selling.



- Patented concealed spring
- Adjustable hooks
- Functional rimlocks

## How to Order

1. Build item number beginning with 67-  
(See fitting guide pages for both shape code and shape size availability.)
2. Add shape code from the following pages.
3. Add frame size.
3. Add frame color code.  
Black: BL      Bronze: BR  
Gold: GO      Gunmetal: GU
4. Add lens color code.  
Gray: 1      Brown: 2

## Sample Product Code

Note: All product codes start with 67-

67-	XLO	54	BL	1
	Shape	Size	Frame Color	Lens Color

## 28 Piece Starter Kit

67-28STARTERKIT      \$399.99

US Patent # 6,234,628  
EU Patent # 1116984



## Shade Control® Clip-Ons Actual Size Fitting Guide

Place frames over the best-fitting colored shape



Wayfarer

Shape code WAY

Not available in gold  
or gunmetal frame

54mm

57mm

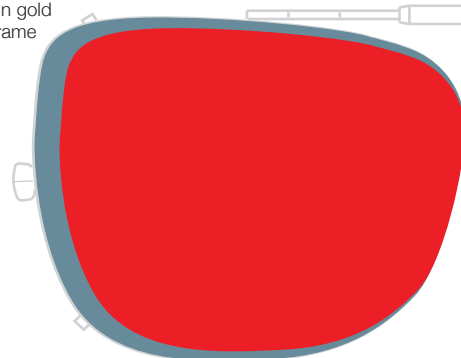

**Tru-Rectangle**  
Shape code TRUX

Not available in gold frame

48mm  
50mm  
52mm  
54mm  
56mm

**Modified Rectangle**  
Shape code MODX

46mm  
48mm  
50mm  
52mm  
54mm

**Lo-Oval**  
Shape code OLO

42mm  
44mm  
46mm  
48mm  
50mm

**Almond**  
Shape code ALM

48mm  
50mm  
52mm

**Lo-Rectangle**  
Shape code XLO

44mm  
46mm  
48mm  
50mm  
52mm  
54mm  
56mm

**Rectangle**  
Shape code X

48mm  
50mm  
52mm  
54mm  
56mm

**MDX**  
Shape code MDX

Not available in gold frame

52mm  
54mm

**Mod-Oval**  
Shape code MODO

Not available in gold frame

50mm  
52mm

# Shade Control® Clip-Ons Actual Size Fitting Guide

**\$20.99**  
per clip



Not available in gold frame

- 52mm
- 54mm
- 56mm

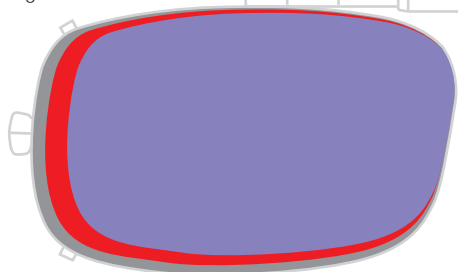

Not available in gold frame

- 56mm
- 58mm

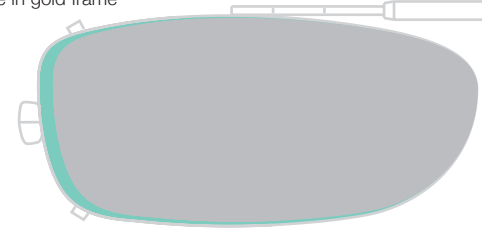

Not available in gold frame

- 48mm
- 50mm
- 52mm
- 54mm
- 56mm

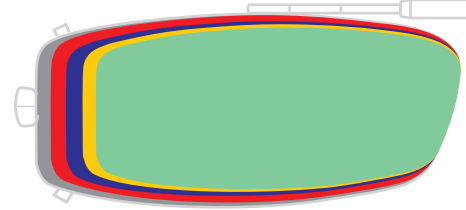

- 42mm
- 44mm
- 46mm
- 48mm
- 50mm
- 52mm

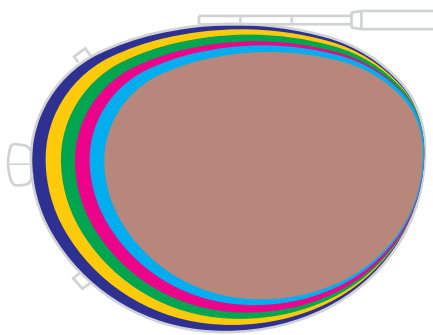

Not available in black frame

- 52mm
- 54mm
- 56mm
- 58mm

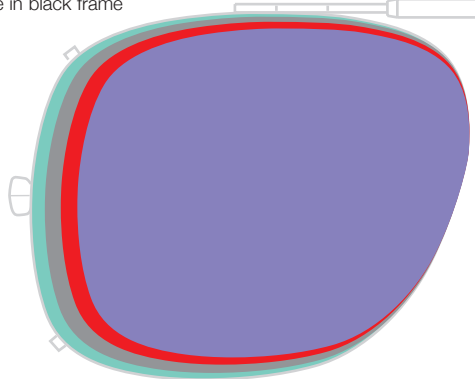

Not available in gold frame

- 52mm
- 54mm

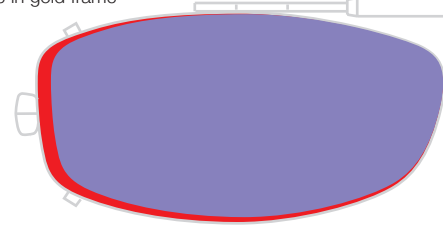

- 46mm
- 48mm
- 50mm

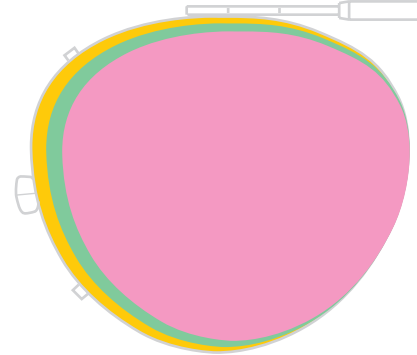

- 48mm
- 50mm
- 52mm

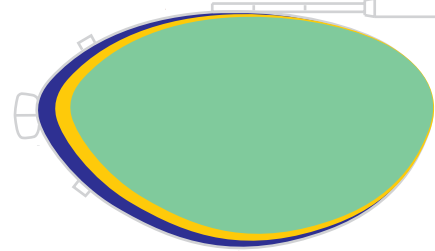





# Signature Fits Over Sunwear

High Fashion Sunglass Collection

- Optical grade polarized lens technology with zero friction surface
- BendToFit™ Temples

**\$19.99**  
each

## FREESIA 1

Chocolate Frame, Amber Lens



## FREESIA 2

Gloss Black Frame, Gray Lens



## DAHLIA 1

Gloss Black Frame, Gray Lens



## DAHLIA 2

Gloss Black Frame, Gray Lens



Freesia 1	Chocolate Frame	Amber Lens	53-3HSD116E3S1
Freesia 2	Gloss Black Frame	Grey Lens	53-3HSD11690S1

Dahlia 1	Gloss Black Frame	Grey Lens	53-3HSG11690S1
Dahlia 2	Gloss Black Frame	Grey Lens	53-3HSG11690SY



# Dry Eye Relief Sunglasses

**\$16.95**  
each

- Comfortable dual layer foam gasket helps retain moisture around the eye
- Rx-able
- BendToFit® temples
- Scratch resistant polycarbonate lenses
- Anti-fog lens coating

The dual layer foam gasket provides a barrier to the eyes for patients with sensitivities from dry eyes, allergies, dust, wind, and extreme bright light. Frame and lenses provide 50% more protection from sun and elements than conventional sunglasses.



Foam Gasket

6 Piece Empty Countertop Display  
53-17P204DESZ \$53.99  
FREE with purchase of 12 sunglasses



Medium Modified Rectangle	
Black/Smoke	53-5FX359SF2A
Tortoise/Copper	53-5FX355F2TA



Large Modified Rectangle	
Black/Smoke	53-5FX5559SF2A
Tortoise/Copper	53-5FX5555F2TA



Large Square	
Black/Smoke	53-5F5559SF2A
Tortoise/Copper	53-5F5555F2TA



Extra Large Square	
Black/Smoke	53-5F5659SF2A
Tortoise/Copper	53-5F5655F2TA



Medium Oval	
Black/Smoke	53-5FS0500SF2A
Tortoise/Copper	53-5FS0555F2TA



Medium Large Rectangle	
Black/Smoke	53-5F1050SF2A
Tortoise/Copper	53-5F10555F2TA

# HAVEN

FITS OVER SUNWEAR™

OPTIFY™  
LENS TECHNOLOGY



- Polarized to reduce glare
- Hardcoat offers 2X more scratch resistance than coating on ordinary sunglasses
- Oleophobic coating repels water, oil and smudges

- Lightweight, nylon frame
- BendToFit® temples on most styles
- Lenses block 100% UVA/UVB



- Over the glass protection
- Polarized
- Water Repellent
- Anti-Smudge
- Tough Coat

## Fits Over Sunwear

\$14.99  
each

### Fashion Collection

Contemporary styling without side lenses



**Avalon**  
Fits over Rx glasses not exceeding  
5-1/2"W x 1-1/4"H



**Solana**  
Fits over Rx glasses not exceeding  
5-1/2"W x 1-1/4"H



**Sunset**  
Fits over Rx glasses not exceeding  
5-3/8"W x 1-5/8"H



**Balboa**  
Fits over Rx glasses not exceeding  
5-3/8"W x 1-5/8"H

Avalon	Gloss Black Frame - Gray Lens	53-3HG2690S
	Tort Frame - Amber Lens	53-3HG2653ST
	White Frame - Gray Lens	53-3HG2660S
Sunset	Mocha Frame - Amber Lens	53-3HC643S
	Tort Frame - Amber Lens	53-3HC653ST
	Midnight Blue Frame - Gray Lens	53-3HC620S
Solana	Gloss Black Frame - Gray Lens	53-3HG690S
	Midnight Blue Frame - Gray Lens	53-3HG620S
	Tort Frame - Amber Lens	53-3HG653ST
Balboa	Gloss Black Frame - Gray Lens	53-3HK690S
	Gloss Wine Frame - Gray Lens	53-3HK6W0S
	Tort Frame - Amber Lens	53-3HK653ST

### Classic Collection

Traditional shapes provide optimal coverage



**Summerwood**  
Fits over Rx glasses not exceeding  
5-3/8"W x 1-7/8"H



**Windemere**  
Fits over Rx glasses not exceeding  
5-1/2"W x 1-1/4"H



**Meridian**  
Fits over Rx glasses not exceeding  
5-1/4"W x 1-1/2"H



**Banyan**  
Fits over Rx glasses not exceeding  
5-1/2"W x 1-1/4"H

Summerwood	Black Frame - Gray Lens	53-3H4600S
	Black Frame - Yellow Lens	53-3H4607S
	Matte Tort Frame - Amber Lens	53-3H46543ST
	Tort Frame - Amber Lens	53-3H4653ST
Meridian	Black Frame - Gray Lens	53-3H5600S
	Black Frame - Yellow Lens	53-3H5607S
	Tort Frame - Amber Lens	53-3H5653ST
Windemere	Black Frame - Gray Lens	53-3H2W600S
	Tort Frame - Amber Lens	53-3H2W653ST
Banyan	Black Frame - Gray Lens	53-3H3600S
	Matte Tort Frame - Driving Lens	53-3H36543ST

## Panorama Collection

Wrap-around lenses allow for maximum peripheral view



Tolosa

Fits over Rx glasses not exceeding  
5-1/2"W x 1-1/2"H



Malloy

Fits over Rx glasses not exceeding  
5-1/3"W x 1-1/3"H



Foxen

Fits over Rx glasses not exceeding  
5-1/2"W x 1-1/4"H



Hunter

Fits over Rx glasses not exceeding  
5-5/8"W x 1-5/8"H

Tolosa	Black Frame - Gray Lens	53-3HRT600S
	Tort Frame - Amber Lens	53-3HRT653ST
Foxen	Black Frame - Gray Lens	53-3HRN600S
	Midnight Blue Frame - Gray Lens	53-3HRN620S
	Tort Frame - Amber Lens	53-3HRN653ST
Malloy	Black Frame - Gray Lens	53-3HRM600S
	Tort Frame - Amber Lens	53-3HRM653ST
Hunter	Black Frame - Gray Lens	53-3HRH600S
	Matte Tort Frame - Amber Lens	53-3HRH6543ST
	Tort Frame - Amber Lens	53-3HRH653ST

## Sport Collection

Vented frame helps reduce fogging



Rainer

Fits over Rx glasses not exceeding  
5-1/2"W x 1-1/2"H



Biscayne

Fits over Rx glasses not exceeding  
5-1/3"W x 1-1/3"H



Denali

Fits over Rx glasses not exceeding  
5-1/2"W x 1-1/4"H



Everest

Fits over Rx glasses not exceeding  
5-5/8"W x 1-5/8"H

Rainer	Soft Touch Black Frame - Gray Lens	53-3HX600S
	Tort Frame - Amber Lens	53-3HX653ST
Denali	Matte Tort Frame - Amber Lens	53-3HW116543ST
	Soft Touch Black Frame - Gray Lens	53-3HW11600S
Biscayne	Soft Touch Black Frame - Gray Lens	53-3HY600S
	Tort Frame - Amber Lens	53-3HY653ST
Everest	Black Frame - Gray Lens	53-3HXX600S
	Tort Frame - Amber Lens	53-3HXX653ST

## Lens Options



YELLOW  
(Available on Classic only.)



GRAY



AMBER

## Displays



18 Piece Empty Floor Display

53-17P208DHNO \$199.99

FREE with purchase of 18 sunglasses

6 Piece Empty Countertop Display

53-17P204DHNO \$53.99

FREE with purchase of 12 sunglasses



## Guardian Safety Eyewear Collection



Comfortable over-glass safety glasses especially designed to protect user's eyes from airborne particles and substances. Both Guardian® and Guardian Pro® are ANSI and OSHA approved, come with UV400 Polycarbonate protection, and Anti-Scratch coated lenses.

### Size Chart for both Guardian and Guardian Pro

Fits over frames up to:

<b>M</b>	5 1/4" W x 1 1/2"H • 132mm x 38mm
<b>M/L</b>	5 1/2" W x 1 5/8"H • 139mm x 41mm
<b>L</b>	5 3/8" W x 1 7/8"H • 137mm x 47mm

**\$4.99**  
each

### Guardian®

- Wear over Rx glasses or alone
- Lightweight frames

Smoke



Medium - 53-25G88HS  
M/L - 53-2XG88HS  
Large - 53-29G88HS

Yellow



Medium - 53-25G77HS  
M/L - 53-2XG77HS  
Large - 53-29G77HS

Clear



Medium - 53-25G66HS  
M/L - 53-2XG66HS  
Large - 53-29G66HS

**\$8.99**  
each

### Guardian Pro®

- Wear over Rx glasses or alone
- Wraparound protection
- Flexible Temples/Lightweight frames



Medium - 53-25E88GS  
M/L - 53-2XE88GS  
Large - 53-24E88GS



Medium - 53-25E77GS  
M/L - 53-2XE77GS  
Large - 53-24E77GS



Medium - 53-25E66GS  
M/L - 53-2XE66GS  
Large - 53-24E66GS

## Swim Flex

Rx Swimming Goggles

**\$9.99**  
each

- Powers range from -2.0 to -8.0, and Plano
- UV protection
- Anti-fog polycarbonate lenses
- Interchangeable nose pieces (S, M, and L)
- Made from 100% silicone
- Double head strap design prevents sliding



### How to Order

1. Build item number beginning with 99-291
2. Add color code.
3. Add power code:  
2.0, 2.5, 3.0, 3.5, 4.0, 4.5  
5.0, 5.5, 6.0, 7.0, 8.0, P (Plano)

### Sample Product Code

Note: All product codes start with 99-291

99-291	-	1	-	20
Item #		Color Code		Power

Color Code

- 1 (Black)
- 2 (Blue)
- 3 (Pink)



# Peeper Keepers® Eyewear Holders

Holding on Since 1979

Since 1979, Peeper Keepers has been supplying opticians and retail stores with a wide range of the highest quality eyewear holders available. Their unique grip ends are Made in the USA and are attach permanently to polyester cord, beaded cord, leather, and chain.





- Patented “Stay Put” grip ends secure tightly to any size frame
- No moving parts to work loose
- No sliding up and down the temple



Two-sided display with six metal hooks on each side.

Countertop Display  
95-220 \$79.99  
Retainers not included

## Floating Eyewear Holders

Color	Color Code
	18
Red	18
	01
Black	01
	45
Yellow	45
	44
Blue	44

**\$4.50**  
each

Floating Eyewear Holders  
w/Rubber Tube #600

- Foam and rubber tube combination
- Universal fit
- 17" long

Style Code 0600



## Floating Eyewear Prepack

#600 6-Piece

2 Black, 2 Red, 1 Blue, 1 Yellow

**\$24.30**  
each

99-581-600AST

### How to Order

1. Build item number beginning with 99-581
2. Add 4 digit style code.
3. Add 2 digit color code.

### Sample Product Code

Note: All product codes start with 99-581

99-581	-	0200	18
Item #		Style Code	Color Code



# Eyewear Holders

## Attitube Eyewear Holders

Color	Color Code	
Black	01	
Brown	04	
Red	18	
Navy	09	Only available in #200
Royal	36	
Turquoise	37	
Brown Heather	30	Only available in #200
Black Heather	28	
Blue Heather	29	
Khaki Heather	39	
Pink Heather	34	
Purple Heather	35	Only available in #250



\$3.50 each

### Attitube #200

- Quick dry, poly-Lycra fabric
- Standard size
- 28" long

Style Code 0200



\$3.50 each

### Attitube Lite #250

- Thinner size
- 28" long

Style Code 0250

### How to Order

1. Build item number beginning with 99-581
2. Add 4 digit style code.
3. Add 2 digit color code

### Sample Product Code

Note: All product codes start with 99-581

99-581	-	0200	18
Item #		Style Code	Color Code

## Attitube Prepacks

\$37.80 each

### #200 12-Piece

- 3 Black, 1 Brown, 1 Navy, 1 Red, 1 Royal, 1 Black Heather, 1 Brown Heather, 1 Blue Heather, 1 Turquoise Heather, 1 Aqua Heather

99-581-200AST

### #250 12-Piece

- 3 Black, 1 Brown, 1 Navy, 1 Red, 1 Royal, 1 Black Heather, 1 Khaki Heather, 1 Pink Heather, 1 Turquoise Heather, 1 Aqua Heather

99-581-250AST



## Cord Eyewear Holders

- Super-premium cord with tight braid

Color	Color Code
Purple	13
Peacock	11
Raspberry	16
Pink	12
Bone	03
Black	01
Brown	04
Red	18
Navy	09
Royal	19
Forest	07
Wine	21
Charcoal	22
Rainbow Multi	15
Blue Multi	02
Purple Multi	14
Rasta Multi	17
Gray Multi	08
Brown Multi	05
Navy Stripe	10
Tan Stripe	20
Black Multi	40

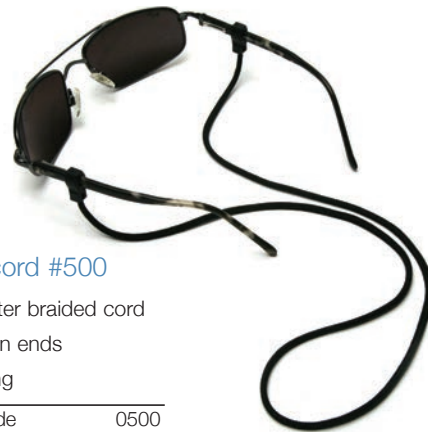

\$2.50 each

**BEST SELLER**

### Supercord #500

- Polyester braided cord
- Slide on ends
- 27" long

Style Code 0500



\$3.00 each

### Supercord Adjustable #550

- Slide on ends and adjustable length slider
- 27" long

Style Code 0550



\$3.00 each

### Sportcord #300

- Supercord with tube ends
- 24" long

Style Code 0300

Only available in Black, Brown, Royal, Navy, Red, Peacock, Raspberry, Back Multi, Rainbow Multi, Blue Multi

## Cords Prepacks

**#500 12-Piece** 99-581-500AST  
3 Black, 1 Brown, 1 Navy, 1 Red, 1 Royal, 2 Blue Multi, 2 Rainbow Multi, 1 Rasta Multi

\$27.00

**#550 12-Piece** 99-581-550AST  
3 Black, 1 Brown, 1 Navy, 1 Red, 1 Royal, 2 Blue Multi, 2 Rainbow Multi, 1 Rasta Multi

\$32.40

**#300 12-Piece** 99-581-300AST  
3 Black, 1 Brown, 1 Navy, 1 Red, 1 Royal, 2 Blue Multi, 2 Rainbow Multi, 1 Black Multi

\$32.40



# Fashion Eyewear Holders

## Czech Eyewear Holders

Color	Color Code
Aqua	55
White	60
Bronze	57
Silver	59
Black	56
Red	58

## Jewel Eyewear Holders

Color	Color Code
Amber	51
Blue	44
Aqua	24
Red	18
Black	01
Mixed	52

## Round Leather

Color	Color Code
Brown	04
Light Brown	47
Black	01

### Round Leather Prepack \$18.90

#1640 6-Piece  
2 Brown, 2 Light Brown, 2 Black  
99-581-1640AST



\$7.50 each

### Czech Beads & Chain #1400

- Authentic Czech glass beads
- 27" long

Style Code 1400

### Czech Prepack

#1400 6-Piece

\$40.50

1 Black w/Silver, 1 Red w/Silver, 1 Silver w/Silver,  
1 Aqua w/Gold, 1 Bronze w/Gold, 1 White w/Gold  
99-581-1400AST



\$6.00 each

### Jewel Glass Beads #1320

- 27" long

Style Code 1320

### Jewel Prepack

#1320 6-Piece

\$32.40

1 Amber, 1 Aqua, 1 Black, 1 Blue, 1 Mixed, 1 Red  
99-581-1320AST



\$3.50 each

### Leather #1640

- 27" long

Style Code 1640





# Kids Eyewear Holders

## Kids Attitube Lite

Color	Color Code
Black	01
Red	18
Royal	36
Aqua Heather	25
Turquoise Heather	38
Pink Heather	34

## Kids Sport Cord

Color	Color Code
Black	01
Red	18
Royal	36
Rainbow Multi	15
Blue Multi	02
Yellow Multi	43
Pink Multi	42

### How to Order

1. Build item number beginning with 99-581
2. Add 4 digit style code.
3. Add 2 digit color code

### Sample Product Code

Note: All product codes start with **99-581**

99-581	-	0200	18
Item #		Style Code	Color Code



\$3.00 each

Kids Attitube Lite #400

• 18" long

Style Code 0400

## Kids Attitube Lite Prepack

#400 6-Piece

1 Black, 1 Red, 1 Royal, 1 Aqua Heather,  
1 Turquoise Heather, 1 Pink Heather

99-581-600AST

\$16.20



\$3.00 each

Kids Sportcord #410

• 17" long

Style Code 0410

## Kids Sportcord Prepack

#410 6-Piece

1 Black, 1 Red, 1 Royal, 1 Blue Multi,  
1 Rainbow Multi, 1 Pink Multi

99-581-410AST

\$16.20



# Eyewear Retainers

Welcome to OptiSource's new eclectic selection of eyewear retainers. Our collection offers a variety from basic strings, to New York City designer collections to suit all customers. Each piece is individually packaged and includes a paperboard hang tab. All retainers are sold individually.

See pages 80-87



Two-sided display with six metal pegs on each side. Holds 48 retainers.

95-217 \$47.49



Hoopie - Silver 42-OSCAHS \$5.79



Round Town 42-OSCARTS \$4.99



Link and Flower 42-OSCALFS \$3.99



Ornamental - Silver 42-OSCBOS \$5.99



Dazzle 42-OSCADS \$3.99















Ornamental Gold 42-OSCBOG \$5.99



Safari 42-OSCASS \$3.99



Golden Flower 42-OSCALFG \$3.99

	Golden Beads	42-OS CABG	\$3.99
	Herringwish	42-OS CAHG	\$3.29
	Classic Gold	42-OS CACG	\$3.29
	Silver Beads	42-OS CABS	\$3.99
	Mamba - Gunmetal	42-OS CMBG	\$2.99
	Mamba - Silver	42-OS CMBS	\$2.99
	Everlink - Gold	42-OS CELGD	\$3.99
	Everlink - Gunmetal	42-OS CELGM	\$3.99
	Finity - Gunmetal	42-OS CFGM	\$2.49
	Finity - Gold	42-OS CFGD	\$2.49
	Carlin Beads	42-OS CCRB	\$2.99
	Petite - Pink	42-OS CBPI	\$5.99
	Petite - Silver	42-OS CBPSI	\$5.99

LENS CLEANER

CASES

ACCESSORIES

DISPENSING

OPTOMETRIC

SURFACING

FINISHING

TOOLS

FRAME PARTS

# ACCESSORIES



Animal Stripe

42-CMC22305

\$10.00



Faceted Copper

42-CMC22333

\$10.00



Desert Sands

42-CMC22377

\$10.00



Pearl Sensation - Peach

42-OSCBPSP

\$4.99



Pearl Sensation - Copper

42-OSCBPSC

\$4.99



Pearl Sensation - Green

42-OSCBPSG

\$4.99



Midnight Splendor

42-OSCBMS

\$5.79



Copper Twinkle

42-OSCBCT

\$5.49



Aura

42-OSCAUR

\$3.49



Asia

42-OSCASI











\$3.49

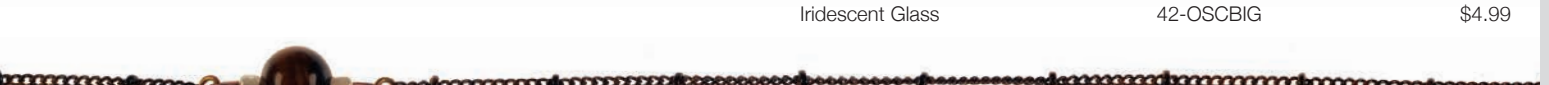

Monarch

42-OSCMON

\$4.49

	Gem Cut - Black	42-OSCBGCBK	\$5.79
	Iridescent Glass	42-OSCBIG	\$4.99
	Gem Cut - Bronze	42-OSCBGCBZ	\$5.79
	Jammin	42-OSCBJ	\$4.99
	Naturale	42-OSCBN	\$4.99
	Squaretones - Natural	42-OSCBSN	\$5.79
	Squaretones - Gray	42-OSCBSG	\$5.79
	Squaretones - Aqua	42-OSCBSA	\$5.79
	Belize - Emerald	42-OSCBLE	\$5.49
	Belize - Tawni	42-OSCBLT	\$5.49
	Belize - Lavender	42-OSCBLL	\$5.49



Octa Necklace Holder  
42-OSHAON  
\$5.39



Earthy Necklace Holder - Ivory  
42-OSHBENI  
\$3.79



Earthy Necklace Holder - Brown  
42-OSHBENB  
\$3.79



Angelica Necklace Holder  
42-OSHANG  
\$5.99



Sophia Necklace Holder  
42-OSHSOPH  
\$4.49

Butterfly Necklace Holder  
42-OSCATNB  
\$3.99

Square Necklace Holder  
42-OSCATNS  
\$3.99

Petals Necklace Holder  
42-OSCATNP  
\$3.99

Flower Necklace Holder  
42-OSCATNF  
\$3.99

# ACCESSORIES



Funtime - Green 42-OSCBFG \$0.99



Funtime - Orange 42-OSCBFO \$0.99



Funtime - Hot Pink 42-OSCBFHP \$0.99



Funtime - Soft Pink 42-OSCBFSP \$0.99



Funtime - Purple 42-OSCBFP \$0.99



Funtime - Blue 42-OSCBFB \$0.99



Optistrap Neoprene - Yellow 42-OSPYELLOW \$1.99



Optistrap Neoprene - Green 42-OSPGREEN \$1.99



Optistrap Neoprene - Blue 42-OSPBLUE \$1.99



Optistrap Neoprene - Red 42-OSPREDD \$1.99



Optistrap Neoprene - Black 42-OSPBLACK \$1.99



Optistring - Brown 42-OSGBROWN \$0.99



Optistring - Green 42-OSGGREEN \$0.99



Optistring - Black 42-OSGBLACK \$0.99



Optistring - Navy 42-OSGNAVY \$0.99



Optistring - Purple 42-OSGPURPLE \$0.99



Flat Sewn Nappa Leather - Natural 99-OCFSNN \$3.79



Flat Sewn Nappa Leather- Rust 99-OCFSNR \$3.79



Flat Sewn Suede - Black 99-OCFSSB \$3.79



Flat Sewn Suede - Choco Brown 99-OCFSSCB \$3.79



Braided Leather - Choco Brown 99-OCBLCB \$4.49



Braided Leather - Natural/Brown 99-OCBLNB \$4.49





Opticord - Brown 42-OCDBROWN \$1.69



Opticord - Burgundy 42-OCDBURGUNDY \$1.69



Opticord - Navy 42-OCDNAVY \$1.69



Opticord - Black 42-OCDBLACK \$1.69

## Cablz

The Cablz patented design keeps retainers off of your neck for a more comfortable wearing experience. The surgical steel or monofilament designs are feather light, and the exclusive rubber ends grip tight and will not melt or stain. Offer the brand that patients demand - Original Cablz.

\$6.50 each

### Cablz Classic

Black	30-CABLZBK
Monoz (Blue)	30-CABLZMONO
Black XL	30-CABLZBKXL
Monoz XL (Blue)	30-CABLZMONOXL

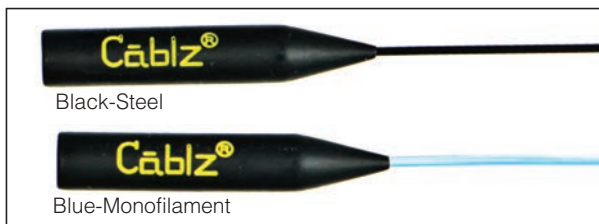

Display 30-CABLZDISPL \$28.00

## Cablz Zipz

\$9.50 each

Zipz takes Cablz to the next level by adding infinitely adjustable sliders. They can be worn at regular length or adjusted for a closer fit to the back of the head.

### Cablz Zipz

Black	30-CABLZBKZ
Blue	30-CABLZMONOZ



ACCESSORIES



LASH

\$12<sup>00</sup>  
each

Volumizing Primer

A silky, matte formula lash primer with conditioning peptides that prepares the surface of the eyelash for the maximum effects of mascara application.

99-321-1507

Size: 7.39 mL

3 month supply

MSRP: \$24.00

\$12<sup>00</sup>  
each

Volumizing Mascara

A buildable, high performance mascara designed to lengthen and volumize natural eyelashes.

Raven - 99-321-612

Espresso - 99-321-1631

Size: 7.39 mL

3 month supply

MSRP: \$24.00

\$12<sup>00</sup>  
each

Defining Liner Eyeliner

A richly pigmented cream formula for long-lasting, smudge-proof wear.

99-321-2795 Raven/Black

99-321-2796 Java/Brown

Size: 0.3 g

3 Month Supply

MSRP: \$24.00



BROW

\$55.00  
each

RevitaBrow Advanced

A breakthrough, category-leading eyebrow conditioner featuring a high impact, proprietary technology for iconic-looking eyebrows.

99-321-2039

Size: 3.0 mL

4 month supply

MSRP: \$110.00

\$16.00  
each

Hi-Def Tinted Brow Gel

A multi-tasking, breakthrough eyebrow setting gel that helps to control, enhance and condition eyebrows for immediate, dramatic results.

Soft Brown - 99-321-2241

Dark Brown - 99-321-2685

Size: 7.4 mL

MSRP: \$32.00



Full Beauty Bar

\$900.00

Includes:

- 8 Eyelash conditioners
- 3 Eyebrow conditioners
- 3 Primers
- 5 Mascara Raven
- 4 Eyeliners
- 4 Brow Gels
- Premium counter top display (\$200 Value)

\$1,800.00 Retail Value

# RevitaLash® ADVANCED

Breakthrough, Category-Leading Cosmetic Formula Created to Condition, Revitalize, and Beautify the Eyelashes

- New, premium profit category
- Repeat buying cycle
- Easy to sell - easy to use
- Turn-key introductory deal
- Sales & marketing support
- Trusted name with millions of loyal satisfied customers worldwide

\$65.00 each



Not available for sale in CA

3.0ml - 4 month supply (\$130.00 MSRP) 99-321-1278



## Introductory Offer Kit

\$325.00

(5) Revitalash® Advanced 3.0mL

Receive FREE with purchase:

- (1) 5-pc display with empty Revitalash® Advanced display tube
- (2) Revitalash® Advanced 1.0mL samples
- (1) 10-pk consumer brochures
- (1) Revitalash® 15" window decal

\$650.00 Retail Value

99-321-1967

## Low Vision Aids



### 3x ZELCO FLX Tabletop Lumifier with 5x bifocal

- 3x magnifying lens with a 4" diameter
- Ideal for optical professionals and patients
- Includes super bright, cool white LED bulbs (Requires 4 "AA" batteries.)

Item	Power	Price
35-570285	3x	\$52.92

## Classic Hand-Held Magnifiers



Rectangle (Includes a protective case)

Item	Power	Lens Size	Price
35-5449	2.4x	4"x3"	\$61.06
35-5438	2.5x	3.3"x2.5"	\$54.02
35-5432	3.5x	2.5"x2"	\$39.85
35-5460 (Round)	5.4x	1.9"	\$42.89

## 3x Designer Folding Reading Magnifier With LED Light

- Easy-to-hold handle folds flat against the lightweight silver-tone frame
- For patients who prefer rectangular magnifiers
- Lens size measures 3.5" x 2.5" (Includes one 'AAA' battery.)



Item	Power	Lens Size	Price
35-454382	3x	2"x4"	\$26.95

Visit our website for our full line of low vision aids

## 3M Press-On Lenses

\$19.99 each

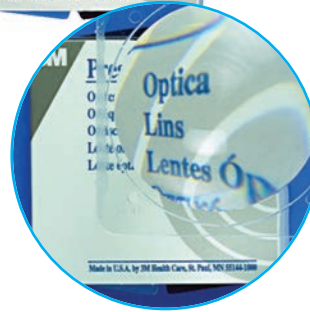

Item	Power	Code
------	-------	------

### Press-On Aspheric Lenses

+0.5D	08-3M495284
+1.0D	08-3M495292
+1.5D	08-3M495227
+2.0D	08-3M495235
+2.5D	08-3M495243
+3.0D	08-3M657818
+3.5D	08-3M495185
+4.0D	08-3M495193
+5.0D	08-3M657800
+6.0D	08-3M495219
+7.0D	08-3M495144
+8.0D	08-3M495151
+10.0D	08-3M495169
+12.0D	08-3M495177
+14.0D	08-3M495060
+16.0D	08-3M495078
-1.0D	08-3M495086
-2.0D	08-3M495094
-3.0D	08-3M495029
-4.0D	08-3M495037
-5.0D	08-3M495045
-6.0D	08-3M495052
-7.0D	08-3M494980
-8.0D	08-3M494998
-9.0D	08-3M495003
-10.0D	08-3M495011
-11.0D	08-3M494949
-12.0D	08-3M494956
-13.0D	08-3M494964
-14.0D	08-3M494972

Item	Power	Code
------	-------	------

### Press-On D-25 Segs (pair)

+1.0D	08-3M495102
+1.5D	08-3M495110
+2.0D	08-3M495128
+2.5D	08-3M495136
+3.0D	08-3M495425
+4.0D	08-3M495433
+5.0D	08-3M495441
+6.0D	08-3M495458

### Press-On Prisms

1.0D	08-3M495383
2.0D	08-3M495391
3.0D	08-3M495409
4.0D	08-3M495417
5.0D	08-3M495342
6.0D	08-3M495359
7.0D	08-3M495367
8.0D	08-3M495375
9.0D	08-3M653700
10.0D	08-3M495300
12.0D	08-3M495318
15.0D	08-3M495326
20.0D	08-3M495334
25.0D	08-3M495268
30.0D	08-3M495276
35.0D	08-3M657784
40.0D	08-3M657792

# Stick-On Bifocals

\$11.99  
each



Stick-On Bifocals are molded from a proprietary blend of crystal-clear plastic materials that allow them to firmly adhere to the inside of lenses without adhesive, then easily peel off. Stick-On Bifocals provide plus power magnification in an ideal size to be used on glasses, sunglasses, goggles, and masks.

- Crystal clear magnification
- Removable/reusable
- Includes carrying case
- No cutting necessary
- Available in powers from +1.50 to +3.00



Power	Code
+1.50	99-336-150
+2.00	99-336-200
+2.25	99-336-225
+2.50	99-336-250
+3.00	99-336-300



◀ Sticks here too!



# Auto Visor Clips

\$1.39  
each

Never sit on, lose or damage your eyewear again. Our Visor Clips mount to any automobile visor and securely hold your glasses.



Black	99-VISORBLACK
Blue	99-VISORBLUE
Red	99-VISORRED
Silver	99-VISORSILVER

# Snapit Eyeglass Repair Kit

Screw it in, Snap it off

This pocket-size eyeglass repair kit allows your patient to repair their eyeglasses anytime-anywhere.

- Includes 5 different size Snapit screws and special screwdriver
- Insert screw into any hinge or eyewire, once tightened, the long feeder tab simply snaps off leaving a smooth finish
- Display holds 12 repair kits
- Sold in cases of 24



02-REPAIRKIT \$1.99

USA Patent Numbers: 8070403, 8375546, 8556556, 899327

# Clip-On Night Light

This featherweight light easily attaches to any eyewear frame and provides a bright, uniform light for any type of activity. The built-in swivel function allows adjustment of light in any direction.

- Great for reading, repair projects, or any low light activity
- Long lasting LR41 batteries included
- Makes a great hands-free exam light for ODs

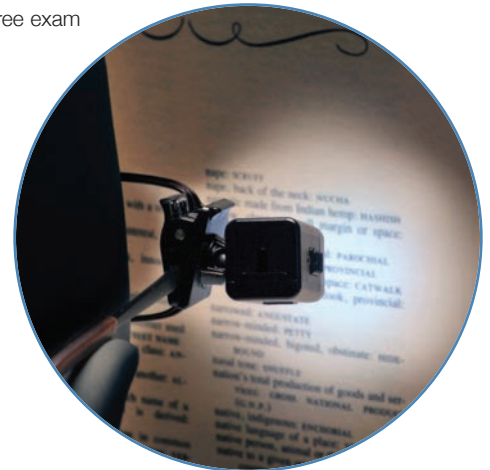

99-240-1 \$9.99

# Dispensing



# Boutique Paper Bags

Our premium retail paper bags are the perfect marketing tool to help you enhance your store's image. Choose from any of our matte finish boutique bags and bring elegance to your patients' purchases.

- Three different sizes
- 6 different matte colors
- 100 bags per box

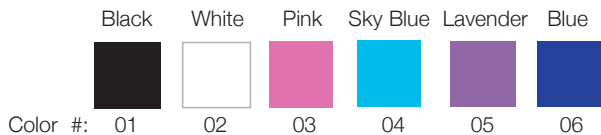

### How to Order

1. Build item number beginning with 99-395
2. Add size code from below dimensions.
3. Add color code from color swatches (left).

Sample Product Code

Note: All product codes start with **99-395**

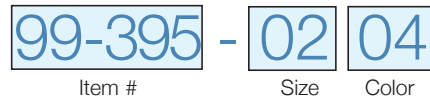

+\$0.15 for imprinting (Minimum 500 pieces) \$30 one-time plate charge.

## Large Vertical Bag

10"(W) x 4"(D) x 12"(H)  
Size #01

54¢  
per bag



## Horizontal Bag

10"(W) x 6"(D) x 8"(H)  
Size #02

49¢  
per bag



## Small Vertical Bag

8"(W) x 4"(D) x 10"(H)  
Size #03

44¢  
per bag



# Optical Design Bags

\$59.99  
100 bags

## Non-Woven Bags

Eco-friendly and economical bags offer unparalleled sturdiness and durability.

- 100% recyclable
- Reusable and hand washable
- 7 1/2" x 7" x 4"
- 100 bags per case

99-43-1



## Paper Bags

European style bags with a high gloss finish are sure to provide elegance to your customers' purchase. The paper bags feature a reinforced folded top with a twisted rope handle and paperboard bottom for stability.

- Two different styles: eyeglass design and plain white
- 8" x 7" x 4"
- 100 bags per case

99-264-1





# Retail Plastic Bags

These optical-themed bags are made of durable plastic with a die-cut reinforced handle for easy carrying.

- Eight unique optical designs (one side print)
- Large bag size: 12" x 16"
- Small bag size: 8" x 12"
- 100 bags per case

**\$15.99**  
100 bags

Large

Bag Style

Cool Glasses  
Eyecare  
See You  
Eye Chart  
Thank You  
Our Focus  
Family  
Words

64-COOL-LG

64-EYECARE-LG

64-SEEYOU-LG

64-CHART-LG

64-THANKYOU-LG

64-FOCUS-LG

64-FAMILY-LG

64-WORDS-LG

**\$9.99**  
100 bags

Small

64-COOL-SM

64-EYECARE-SM

64-SEEYOU-SM

64-CHART-SM

64-THANKYOU-SM

64-FOCUS-SM

64-FAMILY-SM

64-WORDS-SM



Cool Glasses



Eyecare



See You



Eye Chart



Thank You



Our Focus



Family



Words

# Frame Displays

Wood and Metal Tower



95-201 \$78.49

Tri-Spoke Swivel Display

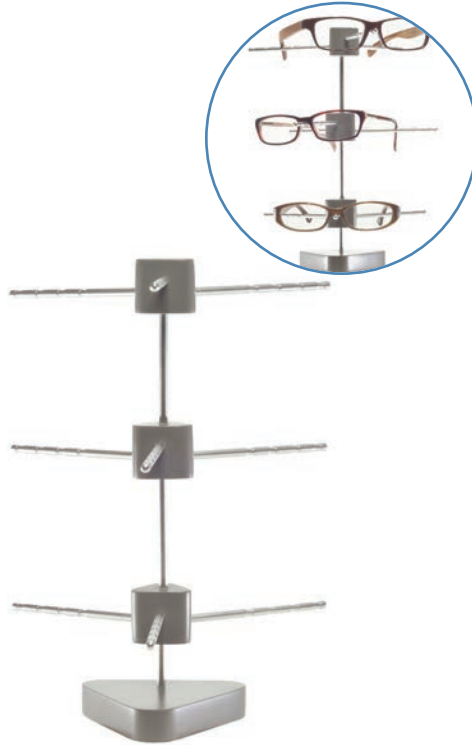

95-202 \$41.49

Four Frame Square Bar



95-203 \$44.99

Acrylic Panel



White Accent  
95-204 \$31.49



Black Accent  
95-205 \$31.49

Four Frame Tilted Panel



95-206 \$39.99

Five Frame Rod



95-207 \$16.99

3-Frame  
Wooden Base



95-218 \$42.99

Three Frame Rod



95-208 \$12.99

Tiered Frame Riser



3 Tier	95-212	\$11.99
4 Tier	95-213	\$17.99

Acrylic Block



Showcase  
New Arrivals

Gray  
95-210 \$11.49



Clear  
95-209 \$11.49

Invisible Display



95-211 \$49.99

Wave Display



3 Tier	95-214	\$15.99
5 Tier	95-215	\$19.99

Wood and Acrylic Panel



95-216 \$35.49

## Head Displays

\$24.99  
each

Half the space, all the display! The Head displays are a new way to showcase your frame lines. They are stackable and interchangeable with three different colors.



Black	99-247-1
Silver	99-247-2
White	99-247-3

## Optitle



### Modular Wall Display System

This rigid and virtually unbreakable display is the smartest way to build your store's wall one tile at a time. The wall-mounted panel can be installed in minutes for a simple yet modern way to display frames.

- Includes 6 frame holders and necessary mounting hardware
- Dimensions: 7"(W) x 16 3/8"(H) x 1"(D)



92-OPTITILE1 \$35.00

## Wood Presentation Tray

Our wood-finish dispensing tray is great during frame selection to hold potential frames, as well as a presentation tray for finished eyewear.

- Three compartments
- Black wood finish
- Satin lined compartments
- Measures: 10" x 7" x 2.25"



99-PRESTRAY \$24.99

## Swinger® Mirror

Pull Down When You Want It,  
Push Up When You're Done

This highly innovative mirror can be mounted to any drop or drywall ceiling in any retail environment while utilizing optimum retail display space more efficiently. With a simple pull-down push-up motion, the Swinger® mirror eliminates the clutter of table top and hand held mirrors.

- Frees countertop space
- Always available at your fingertips
- Customer convenient
- Two sided 9" mirror
- 10' retractable cord
- Shatter proof acrylic mirror

99-392-01 \$159.99



## Sunglass Wall Mirror

One-of-a-Kind Optical Shop Design

These eyeglass shaped mirrors are the perfect fit for those hard-to-decorate wall spaces and also provide another reason for your patients to see how great they look with their new pair of glasses.

- Product Dimension: 46" W x 13" H

\$120.00  
each



Black

99-322-1



White

99-322-2



Distressed Oak

99-322-4



Dark Walnut

99-322-3



Natural

99-322-5

Large  
4-Foot  
Mirror

# Mirrors

## Wooden Base Table-Top Mirror



95-105 \$54.99

## Dispensary Pro Mirror

- Heavy weight base and aluminum posts
- Smooth tilting action
- 12" x 14", 5" deep base



95-104 \$64.99

## Handle Mirror

- 8" x 10", 4" deep base
- Side handle design prevents fingerprints on mirror
- Fixed angle for counter viewing

Handle Prevents  
Fingerprints  
on Mirror



White	95-100	\$29.99
Charcoal	95-101	\$29.99

## Picture Frame Mirror

- Glossy bold frame
- Smooth tilting action
- 10 3/4" x 10 3/4", 3" deep base

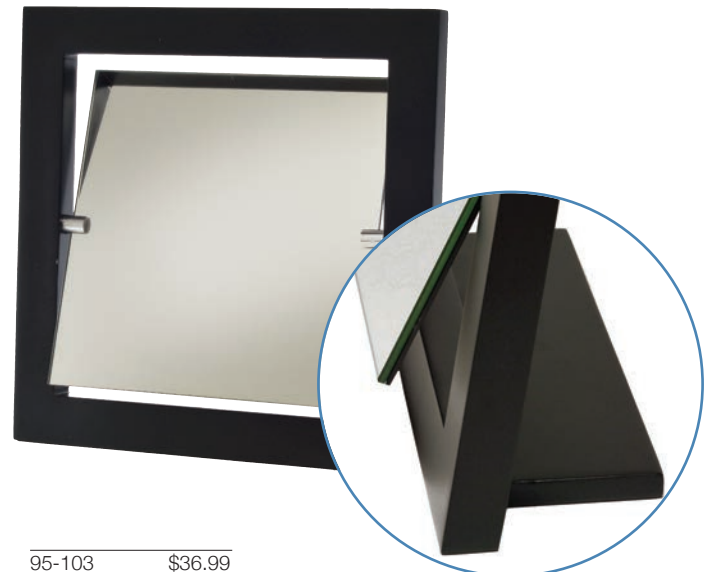

95-103 \$36.99

## Oval Mirror with Swivel Magnified Inset

- 17" tall
- 8" x 12" oval mirror with 4" inset mirror
- 3x and 8x magnification in inset mirror
- Chrome finish

Great for Contact Lens Fittings



99-894-4 \$89.99

## Large Oval

- 19" tall
- 10 1/2" x 15" oval mirror
- 1x magnification
- Brushed stainless steel finish



99-251-1 \$74.99

## Two-Sided Classic Oval 1x and 3x

- 15" tall
- 8 3/4" x 5 1/2"
- Satin nickel finish



95-102 \$54.99

## Two-Sided Bottom Swivel

- Twin - 6 1/2" mirror
- 12 1/2" tall
- Dual sided mirror
- 5x and 1x magnification
- Satin nickel finish



99-894-2 \$29.99

## Two-Sided Acrylic 1x and 5x

- 6 1/4" mirror
- 8 1/2" tall
- 5x and 1x magnification



99-894-3 \$29.99

# DISPENSING

## Frame Tags



**Non-Slip Plastic Op-Tags**

- White
- 11/16" x 2"
- 1,000 count

75-SO830 \$98.50



**Paper Direct Thermal Tags**

- White
- 1 1/8" x 1 3/16"
- 1,000 count

75-DT390 \$33.75



**Simulated Security Tags**

- Silver (S) or Gold (G)
- 5/8" x 1 61/64"
- 1,000 count

75-P409-S \$81.30  
75-P409-G \$81.30



**Non-Slip Plastic Op-Tags**

- Tan
- 2 5/16" X 15/16"
- 1,000 count

75-SO833 \$102.85



**Plastic Slip-On Op-Tags**

- Light Blue
- 11/16" X 1 13/32"
- 1,000 count

75-SO808 \$81.85



**Blank Static Vinyl Labels**

- White (W) or Clear (C)
- 3/8" X 5/8"
- 1,000 count

75-SV151-W \$55.20  
75-SV151-C \$55.20



**Left/Right Contact Lens Indication Labels**

- 3/4" x 7/16"
- 1,000 count

75-P289LRW \$69.80

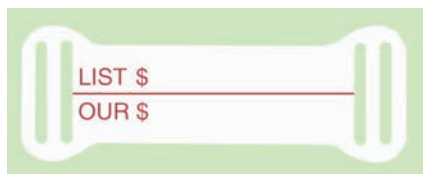

**Frame Tag List/Sale Price**

- 1,000 count

75-P830L \$162.99



**Price Level Dot Label**

- BK, WH, RD, BL
- 1,000 count

75-SV187 \$119.99

## Sticker Remover

Safely remove frame stickers and adhesive with this citrus-based formula.

- 4oz. bottle
- Safe on frames



99-OSSR4 \$4.99

## Acrylic Demo Lenses



- Replace broken or branded demo lenses with these crystal-clear acrylic plano lenses
- 70mm diameter
- 1.1mm thickness
- 6 base
- 50 lenses per box

39-DEMOACRYLIC \$19.99



# Kimberly-Clark® Disposable Wipes



Wypall heavy-duty wiper  
12.5" x 16.8"  
25-34015



Kimwipes EX-L 1 ply  
4.4" x 8.4"  
Shown in pop-up dispenser box  
25-34155



Kimwipes EX-L 2 ply  
11.8" x 11.8"  
25-34705

Kimwipes EX-L 1 ply  
14.7" x 16.6"  
25-34256



Kaydry EX-L 2 ply  
15" x 16.8"  
25-34721

## By the Case

Kimwipes EX-L 1 Ply	15 Boxes	25-34256C	\$139.99
Kimwipes EX-L 1 Ply	60 Boxes	25-34155C	\$194.99
Kimwipes EX-L 2 Ply	15 Boxes	25-34705C	\$139.99
Kaydry EX-L 2 Ply	15 Boxes	25-34721C	\$189.99

## By the Box

Kimwipes EX-L 1 Ply	140 Wipes	25-34256	\$9.99
Kimwipes EX-L 1 Ply	280 Wipes	25-34155	\$3.99
Kimwipes EX-L 2 Ply	119 Wipes	25-34705	\$9.99
Kaydry EX-L 2 Ply	90 Wipes	25-34721	\$13.99
Wypall X60	180 Wipes	25-34015	\$19.99
Dispenser Box	Each	25-PUSHUPBOX	\$14.99

## Ultra Duster™



**NEW  
PRODUCT**

Safely blow away any unwanted micro particles from keyboards, glasses, and many other objects without leaving any residue.

- 10 oz. compressed gas

40-AWDUD12P-1 \$4.99

## Dispensary Cloth w/Loop

Large 16" x 16" Microfiber Cloth with Sewn Loop



**\$4.99**  
each

**NEW  
PRODUCT**



Black	99-331-0302
White	99-331-0301
Gray	99-331-0303

## Digital Hot Air Frame Warmer

We've taken our top-selling adjustable temperature frame warmer design and outfitted it with a digital controller and temperature monitor. The bright LED screen displays the actual temperature inside the housing and the latest working temperature upon restart.



Temperature range: 104°F – 302°F  
 Power: 110V / 800W  
 Weight: 3 pounds  
 Dimensions (W x H x D):  
 3.5" x 6" x 11.5"

32-WARMERDIGITL \$229.99

## Salt Pan Frame Warmer

Quickly achieves optimal temperature, yet stays cool to the touch.



- Quick heating
- Compact size
- Safe and reliable

Temperature range: Up to 400°F  
 Power: 110V / 300 Watts  
 Weight: 4 pounds  
 Dimensions (W x H x D):  
 10.5" x 4.5" x 5"

99-W2500 \$209.99

## Hot Air Frame Warmer

This warmer has a temperature knob that allows for adjustment from 130° to 230°F. Place the frame in the cup and direct heat where you need it.



Temperature range: 130°F – 230°F  
 Power: 110V / 600W  
 Weight: 3 pounds  
 Dimensions (W x H x D):  
 3.5" x 6" x 11.5"

32-WARMERSTNDRD \$199.99

## Glass Beads

These beads transmit heat evenly to the frame. Unlike salt, our glass beads will not lodge in lens grooves or frame parts.

- Useable with any Salt Pan Frame Warmer
- 5 lb containers
- Replace beads every six months for optimal performance



Small (725 micron) 99-OSSGB \$24.99  
 Large (2.5mm) 99-OSLGB \$49.99

# Optometric



# Slit Lamp Camera Phone Adapter

Universal Camera Phone Adapter  
for all Conventional Slit Lamps

If your Slit Lamp does not take digital pictures... Introducing an inexpensive solution that allows eyecare professionals to use their smartphones to upload, store, and share their slit lamp clinical findings.

- Fits all conventional slit lamps
- Fits smartphones up to 3" wide



- Easy Set Up Onto Slit Lamp
- Clamps Onto Eyepiece



- User-Friendly
- Phone is Securely Held in Place with Clamping Pressure



- Take High Resolution Images with Your Smart Phone's Camera

32-SLCA

\$199.99

## Stay Wet Marking Ink

### Oil-Based Formula

Standard water-based marking inks evaporate and dry out in the lensometer marking pin sponge. Stay Wet's oil-based formula keeps sponges saturated for reliable and bright markings every time.

- Dispenser tip bottle
- 10mL

Yellow	99-366-22117
Blue	99-366-22113
Black	99-366-22112
Red	99-366-22111



\$19.99 each

## Lens Marking Ink

Lens Marking Ink leaves a sharp impression when used with lensometers, focometers or layout markers.

- Water soluble
- High visibility
- 2 oz.

Yellow	99-OSMIY
Red	99-OSMIR
Blue	99-OSMIBL
Black	99-OSMIB



\$5.99 each



## Lens Marking Ink II

Our advanced ink formula lasts longer and produces brighter markings. Lens Marking Ink II is designed for lensometers, focometers, layout markers, or any other water-soluble ink application.

- Water soluble
- High visibility
- Dispenser bottle
- 1 oz.

Red	99-260-1
Black	99-260-2
Blue	99-260-3
Yellow	99-260-4



## Axis 221 Lensmeter

### Outer Reading Lensmeter

This finely crafted lensmeter is handmade to the highest standards. The Axis 221 Lensmeter uses superior quality optics, an LED light source, and includes a prism compensator in its user-friendly design. Large ergonomic knobs are clearly marked for ease of use.

32-AXIS221 \$999.99

Also available with self-inking pins

32-AXIS221-SIP \$1,199.99



LED Bulb



Precision Scale



Prism Compensator

Technical specifications:	
Target:	American Cross-line
Vertex Power:	Range: 0D to ±20D
Step:	0.125D up to ±5D
	0.25 at ±5D to ± 20D
Astigmatism Axis:	0 to 180°, minimum scale value 1°
Prism diopter:	1 diopter intervals in the range of 0D to 20D
Prism base angle:	0 to 180°, minimum scale value 5°
Eyepiece focus:	±5D
For lens sizes:	30mm to 90mm in diameter
Overall dimensions:	18" x 6.75" x 9.5"
Weight:	16 pounds
Lighting lamp:	LED 110V 25W equivalent

## PD Rulers

Our PD rulers are multifunctional, indispensable tools. Not only do they accurately measure pupillary distance with three different printed scales, but they will also help during dispensing with a notched hinge-measuring edge and screw thickness gauge (both printed on the rear of the ruler). They are comfortable, lightweight, and medium thickness.

- Choose from two different styles

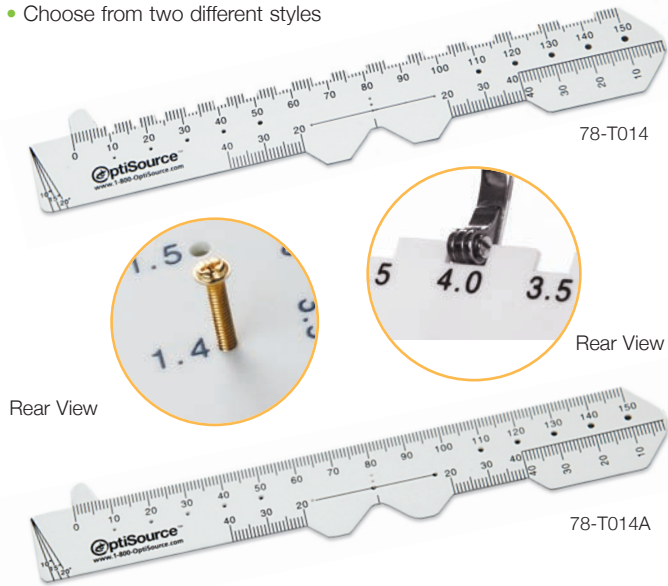

Multi-Function PD Ruler	78-T014	\$1.69
Straight Edge PD Ruler	78-T014A	\$1.69

## Metal PD Ruler



- Stainless steel
- 90mm scales for left or right-handed measurements
- 40mm scale for multifocal and pupil heights

99-359-01	\$2.99
-----------	--------

## Wood and Plastic PD Ruler



- Real wood design with high-contrast polymer-backed metric scale
- Millimeters on the front and inches on the back

99-PDWOOD	\$6.99
-----------	--------

## Distometer

Take the Fuss Out of Vertex Measurements with our Distometer

- Incorrect vertex distance will change the effective power of a prescription
- Avoid costly remakes and troubleshooting time by measuring vertex accurately
- With each distometer, you will receive a conversion scale for easy calculations



86-DISTOMETER	\$182.99
---------------	----------

## PAL Fitting Tool

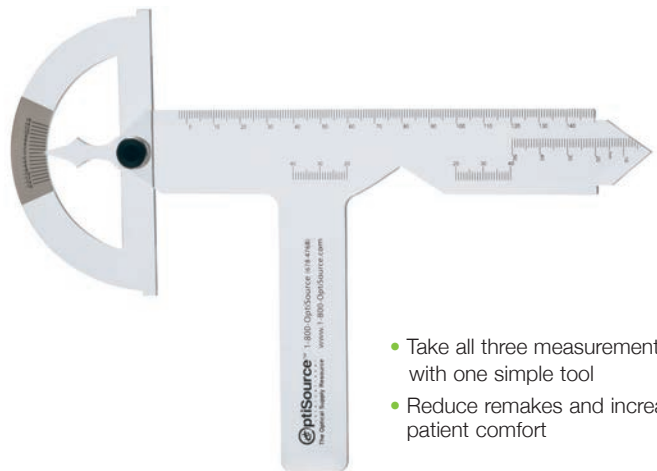

- Take all three measurements with one simple tool
- Reduce remakes and increase patient comfort

Our PAL Fitting Tool is designed to easily measure your patient's PD, Pantoscopic Tilt, and Vertex Distance. This tool will help ensure that your patient's lenses will be properly aligned with their position-of-wear.

78-PALFITTOOL	\$22.99
---------------	---------



## Deluxe Digital Pupilometer

This classic design includes all of today's technology to make it our best pupilometer ever. The durable finish will not chip or fade and is washable. The adjustable LED light source makes reading easy and allows for extra-long battery life.

- Auto shut-off feature is adjustable between 30 seconds and 3 minutes
- Range of focal distance from 30cm to infinity
- Range of measurement from 45 to 82mm binocular PD, 22.5 to 41mm monocular PD
- Graduations in .5mm steps

Power: Uses two AA batteries (Not included)  
 Weight: 1.5 pounds  
 Dimensions (W x H x D): 6.5" x 2.5" x 8.75"

	32-PDMETERDLUX	\$399.99
Bumper		
Black	32-PDBUMPERBLK	\$14.99
Gray	32-PDBUMPERGRY	\$14.99
White	32-PDBUMPERWHT	\$14.99



FDA



### Optional Protective Silicone Bumper

Removable protective bumper available in three colors: black, gray, and white.

## Standard Digital Pupilometer

This quality digital pupilometer's ergonomic design will give you years of reliable, accurate service. It features a large, easy to read LED display that calculates individual and total PD, smooth slider switches, and an illuminated focal point.

- Ergo design is comfortable and functional
- Range of focal distance from 30cm to infinity
- Range of measurement from 48 to 77mm binocular PD, 24 to 38.5mm monocular PD
- Graduations in .5mm steps

Power: Uses four AA batteries (Not included)  
 Weight: 1.5 pounds  
 Dimensions (W x H x D): 6" x 2" x 8.75"

32-PDMETERSTND \$349.99



FDA

## Mini PD Meter

### Easy-to-Use Mini PD Meter for Fast Measurements

- High contrast digital display
- Shows both monocular and binocular PD measurement
- Automatically turns off when placed on a flat surface
- Measuring range: 45-82mm binocular

Power: Uses one 23A 12 Volt battery (Not included)  
 Weight: 0.5 pounds  
 Dimensions (W x H x D): 8.5" x 4.75" x 1.75"



32-PDMETERMINI \$149.99

## Essilor Digital Pupilometer

### The Corneal Reflection Pupilometer for Precise PD Measurements

- Monocular and binocular PD measurements for all distances between 35 cm and infinity
- In case of abnormal patient's binocular vision, monocular PD can be measured
- Range measurement from 48 to 77mm
- Automatic standby

Power: Uses two AA batteries (Not included)  
 Weight: 1.6 pounds  
 Dimensions (W x H x D): 9.8" x 2.36" x 6.3"

40-EOI-4X81705 \$731.99



## Trial Lens Set



Glass Trial Lens Set

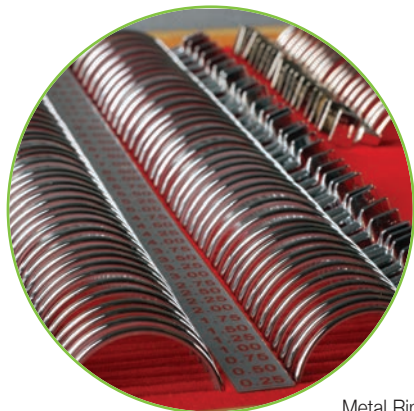

Metal Rims



Fits Most Trial Frames



This complete set of 266 trial lenses includes spheres from +/- .25D to 20.00D, cylinders from +/- .25 D to 6.00D, prism from .50 D to 10.00D, and 10 auxiliary lenses.

- Lenses made of highest quality ophthalmic glass
- Rims constructed of durable metal to ensure longevity of lens set
- Durable aluminum case

32-TRIALLENSSET \$469.99

## Universal Trial Frame

- One size fits all
- No sharp points
- Holds up to 4 pairs of lenses



32-TRIALFRAME \$99.99

## Disposable Clip Penlights

These pen lights are economical, lightweight, and have a pupil gauge printed on them.

- Professional examination light
- Comes with pupil gauge



61-4062 \$13.99



# Eye Charts

## Tumbling E Chart

- Measures 20/200 to 20/10
- Size: 11" x 22-1/2"

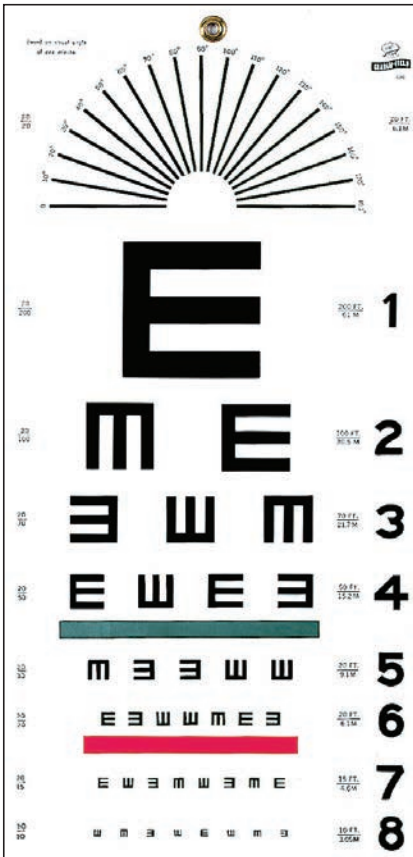

61-1241 \$24.99

## Snellen Eye Chart 20'

- Measures 20/200 to 20/10
- Translucent to work in light boxes
- Size: 11" x 22-1/2"

61-1240 \$24.99

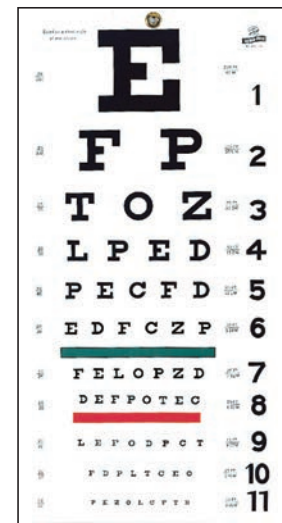

## Eye Chart 10'

- Measures 10/100 to 10/8
- Size: 9" x 14"

11-BBC1264 \$19.99



## Rosenbaum Pocket Vision Screener

- Measures 20/800 to 20/20 at 14 inches
- Size: 3-1/2" x 6-3/8"

11-BRPS \$24.99

## Pediatric Large Vision Test

- Measures 20/200 to 20/10
- Size: 11" x 22-1/2"

61-1243 \$24.99

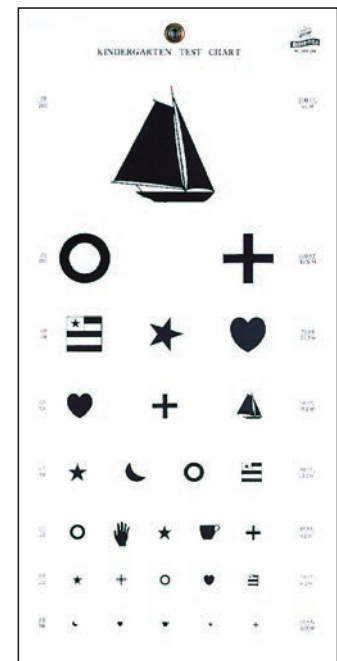

## Near Vision Test Card

- Front: Eye Chart
- Back: Newspaper article
- Size: 5-3/8" x 8"

11-BODNVC \$12.99

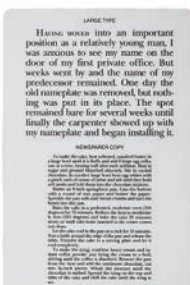

# Ishihara Book

Simple and accurate method for discovering congenital color blindness and red-green blindness, each in two forms, complete and incomplete. Makes use of the peculiarity that in red-green blindness, blue and yellow appear remarkably bright compared with red and green.

- Includes four special plates for tests to determine the kind and degree of defect in color vision
- Color plates encased in specially designed album-type books for ease of handling



## Test Charts

### 10 Plate

61-1257 \$155.99

### 14 Plate

61-1254 \$189.99

### 24 Plate

61-1255 \$243.99

### 38 Plate

61-1256 \$264.99

## Horizontal Prism Bar

Prism bar includes diopters:  
1, 2, 4, 8, 12, 14, 16, 18, 20, 25, 30, 35, and 40.



- Case included

32-PRISMBAR-H \$179.99

## Vertical Prism Bar

Prism bar includes diopters:  
1, 2, 3, 4, 5, 6, 8, 10, 12, 14, 16, 18, 20, 25 and 30.



- Case included

32-PRISMBAR-V \$179.99

## Chin Rest Papers

**\$9.99**  
per 500

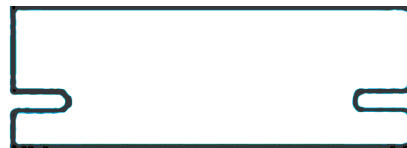

Topcon	07-AJZ7902
Haag Streit	07-AJZ7903
Zeiss, Humphrey 500-600 Series	07-AJZ8029
Nikon 500-600 Series	07-AJZ8014
Burlon, Canon, Cooper Vision / Dicon	07-AJH6202
Mentor AD Optimed	07-AJZ8039
B&L, Mentor, Nidek	07-AJZ7900
Marco Chin	07-AJZ7901



# Hot & Cold Eye Compress



This professional grade eye compress retains heat/cold longer and at a more consistent temperature than leading compresses.

Use **HOT** to alleviate the symptoms of...

- Dry Eye Disease
- MGD (Blepharitis)
- Chalazion (Eyelid Cysts)
- Grittiness
- Irritation
- Sore Eyes

Use **COLD** to soothe the symptoms of...

- Hayfever/Allergies
- Inflammation
- Tired/Itchy/Puffy/Sore Eyes
- Sinus Headaches/Migraine



Use in Oven, Microwave, or Freezer



**\$94.50**

6-Piece Display  
99-340-6

**\$15.75**  
each

Eye Mask  
99-340-1

### Features:

- Reusable
- Hygienic removable washable cover
- Adjustable comfort strap
- Pouch for safe, clean, dry storage

### Innovation with safety in mind...

The Eye Doctor® is filled with BodyBeads®, revolutionary patent pending technology.

- Non toxic
- Non flammable
- Safety tested



## Double Pin-Hole Occluder

\$12.99 each

Pinhole disc is adjustable for assorted positions and alignments.

- Soft foam edging gently hugs facial contours
- Adaptable elastic band to fit all head sizes



Small	66-148S
Large	66-148L

Small:	138 x 48mm
Large:	143 x 54mm

## Plastic Occluder

- 9.5" long
- 2.25" diameter



61-1266	\$9.99
---------	--------

## Suction Cup Occluder

\$7.99 each



Suction cup attaches to the lens while soft sponge edging gently hugs facial contours.

- Blocks out vision
- Fits right or left eye

Small	66-141S
Medium	66-141M
Large	66-141L

## Single Pin-Hole Occluder

\$9.99 each



Adjustable midsection pinhole disc for assorted positions and proper alignment.

- Clip-on spring makes attachment to frame easy and secure
- Soft foam edging gently hugs facial contours
- Available in a variety of sizes for all frames

### Left Eye

Small	66-145SL
Medium	66-145ML
Large	66-145LL
X-Large	66-145XLL

### Right Eye

Small	66-145SR
Medium	66-145MR
Large	66-145LR
X-Large	66-145XLR

### Size Reference

Small:	35 x 55mm	Fits 34-38 Lenses
Medium:	40 x 60mm	Fits 38-42 Lenses
Large:	43 x 65mm	Fits 42-48 Lenses
X-Large:	47 x 70mm	Fits 48-56 Lenses

## Blackout Occluder

\$7.99 each

Clip-on spring makes attachment to frame easy and secure. Soft sponge gently hugs facial contours.

- Completely blocks out vision
- Available in a variety of sizes for all frames



### Left Eye

Small	66-143SL
Medium	66-143ML
Large	66-143LL
X-Large	66-143XLL

### Right Eye

Small	66-143SR
Medium	66-143MR
Large	66-143LR
X-Large	66-143XLR

# Post-Mydriatic Sunglasses

## Instashade Roll-Up Lenses

- Universal size fits directly on face or behind glasses
- 100 per bag



59-E250-808 \$54.99

## Paper Temple Sunglasses

- Adjustable temple length for universal fit
- 100 per bag



Pediatric	99-216-02	\$34.99
Adult	99-216-01	\$39.99

## Slip-In Post Myds

- Slips in behind glasses and rests on temples
- 250 per bag



Pediatric	99-216-04	\$59.99
Adult	99-216-03	\$64.99

## Hook-On Sunglasses

- Slips behind glasses and hooks on top of the frame
- Large size 54mm
- Small size 45mm



Large	66-105L	\$2.99 ea.
Small	66-105R	\$2.99 ea.

## Comfort Eye Patch

\$5.99  
each



Allows eyelid to freely move without pressure from the eye patch.

- Vinyl opaque shield front with comfortable foam edging
- Adjustable elastic band will fit either eye

Black		White	
Large	66-147LB	Large	66-147LW
Small	66-147SB	Small	66-147SW

Small size: 40 x 60mm  
Large size: 50 x 70mm

## Plastic Medical Eye Shield

- Occludes and shields the eye
- 78 x 50 mm (3.1" x 2")
- Package of 12



11-BU130B \$35.99

## Nose Guard

Suspends eyeglasses off the nose to relieve pressure. Perfect for post nasal surgery to eliminate undue pressure from nasal area.

- One size fits all



66-146 \$10.99

## Clip-On Moisture Chamber

\$8.99  
each



### Left Eye

Small	66-144SL
Medium	66-144ML
Large	66-144LL
X-Large	66-144XLL

### Right Eye

Small	66-144SR
Medium	66-144MR
Large	66-144LR
X-Large	66-144XLR

This clear vinyl shield is designed with two attachment options to fit all frames. Soft white foam edging gently hugs facial contours.

- Ideal for dry-eye conditions

### Size Reference

Small:	35 x 55mm	Fits 34-38 Lenses
Medium:	40 x 60mm	Fits 38-42 Lenses
Large:	43 x 65mm	Fits 42-48 Lenses
X-Large:	47 x 70mm	Fits 48-56 Lenses

## Moisture Chamber with Elastic Head Band

\$9.99  
each

Clear vinyl shield with elastic head band includes a soft white foam edging that gently hugs facial contours.

- Ideal for dry-eye conditions
- Fits right or left eye



Large	66-144LB
Small	66-144SB

### Size Reference

Small:	35 x 55mm	Fits 34-38 Lenses
Large:	50 x 70mm	Fits 42-48 Lenses

## Eye Protection for Infant Phototherapy

Provides convenient non-sterile protection for the eyes of infants undergoing phototherapy. Soft vinyl shield section with cotton backing directly covers the eye, protecting against penetrating rays.

- Velcro fasteners
- Adjustable elastic headband fits most infant head sizes



66-138 \$4.99

# Eye Patches

In addition to the bright, colorful, breathable material, these patches easily remain in place around the head using a flexible and comfortable elastic headband. Available in junior or adult sizes.

**\$19.99**  
6 pack



Black Patch

## Adult

Black	78 x 60mm	31-OSPABLK
Primary Colors	78 x 60mm	31-OSPAPRI
Pastel Colors	80 x 60mm	31-OSPAPAS

## Junior

Black	65 x 52mm	31-OSPJBLK
Primary Colors	65 x 52mm	31-OSPJPRI
Pastel Colors	70 x 50mm	31-OSPJPAS



Primary Colors



Pastel Colors



# Eyeglass Patches

**\$7.99**  
each



Blue	17-GIGPBU
White	17-GIGPWH
Dark Green	17-GIGPDG
Black	17-GIGPBK
Navy Blue	17-GIGPNY
Pink	17-GIGPPK
Light Green	17-GIGPLG
Red	17-GIGPRED
Purple	17-GIGPPURPLE
Beige	17-GIGPBG

# Children's Eye Patches

\$7.99  
each



- Fun designs for boys and girls of all ages
- 70 x 55mm



Construction



Candy Hearts



Pink Hearts



Skulls



Butterflies On Yellow



Dog Bone



Girl's Stuff



Fairies



Vehicles



Dark Camo



Heart Grid



Lady Bugs



Watermelon



Sports



Dinosaur



Princess Crowns



Daisies



Butterfly



Big Skulls



Paw Print



Spiders



Rainbow



Cup Cakes



Fire Tiger



Sharks



Baseball



Bats



Big Flowers



Bugs On Pink



Space

Construction	17-GICONSTREP
Candy Hearts	17-GICANDYHRTEP
Pink Hearts	17-GIHEART2EP
Skulls	17-GISKULLE
Butterflies On Yellow	17-GIBFLYYLWEP
Dog Bone	17-GIDOGBONEEP
Girl's Stuff	17-GIGIRLSTUFFEP
Fairies	17-GIFAIRYEP
Vehicles	17-GICARSEP
Dark Camo	17-GICAMOEP

Heart Grid	17-GIHRTGRIDEP
Lady Bugs	17-GILADYBUGEP2
Watermelon	17-GIWTMLNEP
Sports	17-GISPORTSEP
Dinosaur	17-GIDINOEP
Princess Crowns	17-GICROWNSEP
Daisies	17-GIDAISIESEP
Butterfly	17-GIBFLYEP
Big Skulls	17-GIBIGSKLEP
Paw Print	17-GIPAWEP

Spiders	17-GISPIDERSEP
Rainbow	17-GIRNNBWEP
Cup Cakes	17-GICUPCKEP
Fire Tiger	17-GIFIRETGREP
Sharks	17-GISHRKEP
Baseball	17-GIBASEBALLEP
Bats	17-GIBATSEP
Big Flowers	17-GIFLOWEREP
Bugs On Pink	17-GIBUGSKEP
Space	17-GISPACEEP

NOTE: Fabric designs may vary and are subject to change



# Contact Lens Cases

## Sunglass Flat Packs

19¢  
each

Who said we couldn't make flat packs cool? Our rockin' design is the first innovation to flat packs in decades. The living hinge snaps securely to the base with a double lock system to ensure leak-free performance. The raised star wells make retrieving lenses simple.

- Exclusive design
- Available in four popular colors
- Sold in bags of 100

Assorted	74-705
Black	74-704
Red	74-703
Blue	74-702
White	74-701



## Flip-Top Flat Packs

19¢  
each

Our Extra-Deep-Well Flat Packs Feature a Double Hinge Lock Design

Lids snap shut and won't pop open. Ribbed wells allow for maximum lens wetting. Reinforced hinges won't tear or crack.

- Exclusive dual seal in the cap to help prevent leakage
- Reinforced hinge at the lid and base to help reduce tearing
- Imprinting available (1,000 minimum)
- Ribbed well design
- Sold in bags of 100



Assorted	57-1050A
Yellow	57-1050Y
Green	57-1050G
Pink	57-1050P
Clear	57-1050C
White	57-1050W
Blue	57-1050B



## Dome-Top Flat Packs

19¢  
each

This modern design flat pack features a double lock to ensure a leak-free closure. The molded star design in each well makes lens extraction easy. Choose from six modern colors.

- Molded star well design
- Sold in bags of 100



Assorted	99-323-DTA
Blue	99-323-DTB
Green	99-323-DTG
Clear	99-323-DTC
Orange	99-323-DTO
Purple	99-323-DTP
White	99-323-DTW



## Soft Grip Cases

The functional and creative design which has taken conventional contact lens cases to a new dimension. Ergonomically designed cases feature smooth-surface locking caps with leak-proof closures.

- Anti-slip rubber base
- Available in 4 different color combinations
- Display free with 24 pieces

Yellow Blue	74-201
Orange Blue	74-202
Orange Purple	74-204
Yellow Purple	74-203

**\$1.99**  
each



Empty Display 74-205 3.99

## Contact Lens Travel Kit

The hard plastic travel kit securely holds our Soft Grip contact lens case for travel. It includes a Soft Grip case, pair of plastic tweezers, and a glass mirror in the lid.

Note, it is never recommended to transfer contact lens solution from its original container to another container.

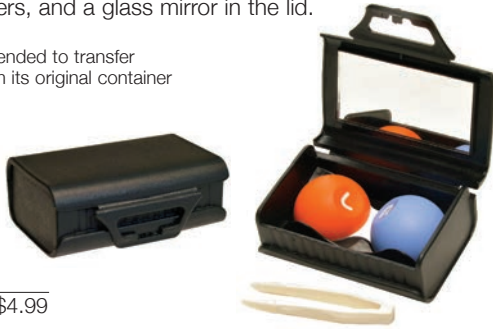

74-301 \$4.99

## Dial-a-Date Cases

**\$2.99**  
each

A dial on each lid allows patients to set a date to remind them when their disposable lenses need to be replaced. For example: your patient wears a biweekly disposable lens on March 7th, they would set the Left lid to "2" and the Right lid to "1", indicating the 21st of the month.

- Distinctive L and R markings on both of the lids and base ensure the lenses are correctly organized
- Soft rubber around the lids provides a smooth and slip-free grip to ensure easily opening and closing
- Anti-slip bottom base
- Leak-proof design features secure locking lids and base



Yellow Purple	74-402
Orange Blue	74-401

## Screw-Top Cases

**49¢**  
each

Our new screw top cases include an injected seal on the lid that ensures a leak-free closure. The molded star design in each well makes lens extraction easy, while the ribbed grip is designed for easy handling.



- Choose from 5 modern colors
- Sold in bags of 100



Assorted	99-369-0100
White	99-369-0101
Blue	99-369-0102
Green	99-369-0103
Orange	99-369-0104
Purple	99-369-0105



# Bubble Cases

\$4.99  
each

Bring fun and variety to your contact lens patients with these unique and colorful designs. Each bubble case includes a standard screw top contact lens case, a practical mirror in the lid, and a 'name and address' card.

- Available in 24 different designs
- Display free with purchase of 12 pieces



Raised bubble graphics

Puppies	74-111
Piglets	74-110
Kittens	74-107
Butterfly	74-108
Red Hearts	74-115
Clownfish	74-109
Zebra Stripe	74-112
Giraffe Print	74-114
Cheetah Print	74-113
Multicolor Hearts	74-116
Green Circles	74-122
Black Plaid	74-121

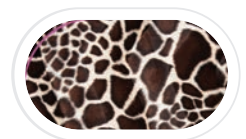

Soccer	74-106
Football	74-104
Baseball	74-101
Hockey	74-103
Golf	74-105
Basketball	74-102
Leaves	74-118
Mountains	74-119
Flowers	74-117
Camo	74-120
Pirate	74-123
American Flag	74-124



Empty Display 74-125 \$1.99

## Leather Cases

This genuine leather case is the stylish way to carry contact lenses. It snugly holds our leak-free screw top contact lens case and has a convenient mirror inside.

- Twelve designs to choose from
- Leak-proof screw top contact lens case
- CE & FDA approved
- Free display with 12 piece purchase

### Solid

White	74-603
Black	74-604
Lime Green	74-602
Pink	74-601
Navy	74-606
Burgundy	74-605

**\$6.99**  
each

### Patterns

Autumn Harvest	74-611
Tartan Plaid	74-612
Green Retro	74-608
Pink Floral	74-607
Blue Star	74-610
Natural Leaf	74-609

**\$7.99**  
each



Empty Display 74-613 \$1.99

## DigiCase

This revolutionary and easy to use contact lens case has a 14 and 30 day digital timer built in. The timer prevents patients from over-wearing lenses and keeps their eyes healthy. The sleek, shiny case features a signature chrome band, a mirror in the lid, and an LCD screen.

- Digital timer reminder built in
- Leak-proof screw top contact lens case
- CE & FDA approved
- Free display with 12 piece purchase

Black	74-501
Green	74-502
Pink	74-503
White	74-504



Empty Display 74-505 3.99

**\$7.99**  
each



## Contact Lens Handling

### DMV® Ultra™

- Inserts and removes Gas Permeable and Hard lenses

72-DMVULTRA \$2.49



### DMV® 45™

- Insertion and removal done at a 45° angle

72-DMV45 \$2.39



### DMV® Classic™

- The best option for Ortho-K lenses

72-DMVCLASSIC \$2.29



### DMV® MagicTouch™

- Hollow shaft provides optional suction for increased control

72-DMVMT \$2.49



### DMV® Scleral Cup™

- Securely grasps the contact lens or prosthetic eye for insertion and removal

72-DMVSC \$3.49



### DMV® Magna Mirror™

- Powerful concave magnifying mirror
- Provides an excellent view of the eye to assist with contact lens insertion and removal
- Suction cup attaches to any smooth surface
- Ideal for suction to vanity mirrors

1 3/4" diameter mirror x 1 1/2" deep

72-DMVMM \$14.99



Visit our website for full selection



**Paremyd 15ml**  
Tropicamide 0.25%,  
Hydroxyamphetamine  
Bromide 0.1%



40-JO750113

**Proparacaine  
0.5% 15ml**



40-JO750012

**Indocyanine Green**  
25mg with Diluent Vial,  
6/box



40-JO1001

**Tropicamide**  
0.5% 15ml  
1.0% 15ml



40-JO743101  
40-JO752812

**Fluorox**  
Fluorescein Sodium 0.25%,  
Benoxinate 0.4%



40-JO750722

**Fluorescein Sodium**  
Ophthalmic Strips 300/box



40-JO743167

**TetraVisc**  
0.5% 5ml



40-JO743468

**Fluorocaine 5ml**  
Fluorescein Sodium 0.25%,  
Proparacaine HCL 0.5%

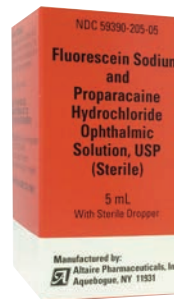

40-JO750721

**Erythromycin  
0.5% 3.5g**  
Ilotycin Ointment



40-JO744115

**Homatropine  
5% 5ml**



40-JO743115

**Tetracaine  
0.5% 15ml**



40-JO743151

**Cyclopentolate  
1% 15ml**  
AK-Pentolate



40-JO750114

**Phenylephrine**  
2.5% 15ml Neo-Syneprine  
10% 5ml Neo-Syneprine



40-JO753015  
40-JO743110

Visit our website for full selection



**Sodium Chloride**  
5.0% 15ml



40-JO745102

**Lissamine Green Strips**  
100/box



40-JO743140

**Neomycin, Polymyxin B, Dexamethasone**  
3.5g



40-JO744136

**Atropine Sulfate**  
1% 5ml



40-JO743140

**Kenalog**  
40mg per 1ml



40-JO744295

**Polymyxin B Sulfate Trimethoprim 10ml**



40-JO744248

**Lidocaine HCl**  
4% 50ml Topical



40-JO746417

**Ofloxacin**  
Ophthalmic Solution 0.3% 5ml



40-JO743395

**Alcohol Pads**

- Saturated with 70% isopropyl alcohol
- 2 Ply
- 1-1/4" x 2-5/8" size
- 200 per box



99-ALCOHOLPAD \$4.99

**PDI Sani-Cloth® Plus**

- Germicidal disposable cloths
- Effective against 16 microorganisms
- Contact time: 3 minutes
- 160 wipes per can



99-PDIQ89072 \$13.49

**PDI Super Sani-Cloth®**

- Germicidal disposable wipes
- Effective against 30 microorganisms
- Contact time: 2 minutes
- 160 wipes per can



99-PDIQ55172 \$13.49



## Bulbs

### Ophthalmic Replacement Bulbs For All Equipment

We will cross-reference and identify lamps for all applications. Simply provide your equipment's make, model, bulb base type, and bulb power.

\*All bulbs are priced per unit and are subject to change.

### Chart Projectors

MFPN	Manufacturer	Volts / Watts / Amps	Application	Code	Price
CAX130V	GE	130V 50W	AO/Reichert 11082, 1215, 1217	24-BT02816	\$8.99
1096	GE	6V 4.5A	AO/Reichert 11800, 11805, 11820, 11825, 12060, 12065	24-BT08168	\$37.99
7388	Philips	6V 20W	AO/Reichert 11075 Long Life, 11083, 778, Chart Projector II	24-BT00986	\$15.99
64261	Osram	12V 30W	Selectra POC, Woodlyn 31500, H-31200, Eye Chart	24-BT00865	\$34.99
50T424DC	Dr Fisher	24V 50W	Marco CP-670, Nikon 89500 Short Life, NP3, NP35, NP3s	24-BT00677	\$44.99
CAX130VHAL	Ushio	130V 50W	Topcon Equivalent 4244020030, Topcon Main ACP-5D, ACP-6D, ACP-6R, ACP-6S	24-BT01166	\$33.99
ESBFHE	Wiko	6V 30W	Various	24-BT01508	\$7.99

### Slit Lamps

MFPN	Manufacturer	Volts / Watts / Amps	Application	Code	Price
6605	Philips	6V	Burton 1000, 800, 850	24-BT02759	\$22.99
7388	Philips	6V 20W	B&L 6V/30W	24-BT00124	\$6.99
64251	Osram Sylvania	6V 20W	Reichert Xcel 200	24-BT00986	\$16.99
64260	Osram Sylvania	12V 30W	Zeiss SL-20	24-BT00862	\$27.99
4034020700	OptiSource	6V 20W	Haag-Streit 1080, Marco IV, G-11, GIV, GXX, Kowa SL-7 Nikon FS-2, FS-3, NS1, CS-2, Zeiss 30SLM	24-BT000864	\$20.99
1468X	OptiSource	6V 4.5A	Topcon SL-2D, SL-1E, SL-2E, SL-4E, SL-7E, SL-3F Main, TRC-45AN, TRC-NW2	24-BT02762	\$79.99
3050F	OptiSource	6V 4.5A	AO/Reichert Main 11666, Campbell 11575, 11580	24-BT04094	\$16.99
53Z	OptiSource	6V 25W	Topcon Main Bulb LM-P5, LM-P6	24-BT02757	\$27.99
			Zeiss 100/16, 125/16	24-BT02767	\$32.99

### Lensometers

MFPN	Manufacturer	Volts / Watts / Amps	Application	Code	Price
25S11FRE17110	OptiSource	110V 25W	Marco 101 Main Illuminator	24-BT02754	\$3.99
25S115C120V	GE	120V 25W	Woodlyn, B&L Vertometer 70	24-BT0002927	\$4.99
41310	Wiko	6V 15W	Topcon Main Bulb 75907	24-BT17201	\$10.99
4232010550	Topcon	6V 18W	Topcon Main Bulb LM-P5, LM-P6	24-BT16203	\$28.99
10S11N130V	OptiSource	120V 10W	AO/Reichert Old Style 11210, 11360, 12604, 12610, 602, 603, 603A, 603B, Intermediate, Screw Base Clear	24-BT03986	\$1.99
15S11102120V	GE	120V 15W	Nikon 74900, LM-3, LM-4, OL-5	24-BT02808	\$2.99
15S11102CF115	Osram Sylvania	110V 15W	Topcon Main Bulb LM-2B, LM-3B, LM-3BC, LM-5, LM-5E,	24-BT0055465	\$1.99

### Keratometers and Ophthalmometers

MFPN	Manufacturer	Volts / Watts / Amps	Application	Code	Price
3006	OptiSource	120V 15W	Marco Main K-1, K-11	24-BT02756	\$2.99
41314	Wiko	6V 2.4W	Topcon Main OM-3, OM-4	24-BT17203	\$8.99
1468X	GE	6V 4.5A	AO/Reichert CLC	24-BT0001094	\$24.99
15S11102CF115	Osram Sylvania	110V 15W	Topcon OM-2	24-BT02844	\$3.99
15S1114120V	W.A. Equivalent	120V 15W	B&L 71-21-35, 71-26-61 AO/Reichert 12990, Burton 2040, Canon RK3, Woodlyn 55070	24-BT02748	\$1.99

### Ophthalmoscope, Indirect

MFPN	Manufacturer	Volts / Watts / Amps	Application	Code	Price
787	GE	6V 10W	Neitz Halogen 10-H, L-41, Halogen 10-H, Halogen L-41 Topcon Halogen 19001, Halogen 19010, ID-5	24-BR01014	\$11.99
1460	GE	6.5V 2.75A	AO/Reichert Indirect	24-BR0002747	\$11.99
3300	W.A. Equivalent	2.5V	Welch Allyn Equivalent G2624	24-BT03860	\$21.99
3800	Welch Allyn	2.5V	Welch Allyn Panoptic	24-BT00324	\$54.99



## Ophthalmoscope, Indirect (continued from previous page)

MFPN	Manufacturer	Volts / Watts / Amps	Application	Code	Price
3900	W.A. Equivalent	2.5V	Welch Allyn Equivalent	24-BT03863	\$19.99
X0488068	Heine	6V 10W	Propper Ind 199189	24-BT02505	\$89.99

## Ophthalmoscope, Direct

MFPN	Manufacturer	Volts / Watts / Amps	Application	Code	Price
3000	Welch Allyn	3.5V .720A	Welch Allyn Original / 11600, 11605, 11610, 11710	24-BT00342	\$36.99
3000	W.A. Equivalent	3.5V .720A	Welch Allyn Equivalent / 11600, 11605, 11610, 11710	24-BT01069	\$23.99
4900	Welch Allyn	3.5V .720A	Welch Allyn Original / 11620, 11630, 11720, 11730, 11735E	24-BT00354	\$47.99
4900	W.A. Equivalent	3.5V .720A	Welch Allyn Equivalent 11620, 11630, 11720, 11730, 11735E	24-BT01074	\$16.99
1011P5055	OptiSource	3.5V	Keeler (Per 2 Pack)	24-BT03945	\$155.99
1012P5006	OptiSource	6V 18W	Keeler Indirect	24-BT03947	\$129.99
1012P5110	OptiSource	6V 10W	Keeler All Pupil, Vantage, (Per 2 Pack)	24-BT02744	\$179.99
X0188042	Heine	2.5V	Heine	24-BT02474	\$46.99



## Perimeter

MFPN	Manufacturer	Volts / Watts / Amps	Application	Code	Price
940750	OptiSource	6V 4.5A	Marco 2007, Haag-Streit Main Bulb 940-750, Goldman Main Bulb	24-BT04976	\$29.99
6V33WSC	OptiSource	6V 33W	Topcon Main Bulb SBP-2020	24-BT04816	\$23.99

## Radiuscopes

MFPN	Manufacturer	Volts / Watts / Amps	Application	Code	Price
1493	GE	6.5V 2.75A	AO/Reichert 11231	24-BT02807	\$8.99

## Retinoscopes

MFPN	Manufacturer	Volts / Watts / Amps	Application	Code	Price
3000	W.A. Equivalent	2.5V	Welch Allyn Equivalent 18000	24-BT01069	\$23.99
3000	Welch Allyn	2.5V	Welch Allyn 18000	24-BT00342	\$35.99
X0288048	Heine	3.5V	Heine	24-BT02495	\$44.96
X0288089	Heine	3.5V	Heine	24-BT02508	\$47.99
X0288090	Heine	3.5V	Heine	24-BT02503	\$38.99



## Tonometers

MFPN	Manufacturer	Volts / Watts / Amps	Application	Code	Price
328	W.A. Equivalent	6V 1.2W	AO/Reichert Non-Contact Tonometer (10 pcs)	24-BT02758	\$9.99



## Transilluminators

MFPN	Manufacturer	Volts / Watts / Amps	Application	Code	Price
994	Carley	3.5V .720A	Welch Allyn Equivalent Transilluminator 27000, 27050, 26500, 41100, 43300	24-BT01073	\$15.99
3100	Welch Allyn	3.5V .720A	Welch Allyn Transilluminator 27000, 27050, 26500, 41100, 43300	24-BT00343	\$30.99



## Microscopes

MFPN	Manufacturer	Volts / Watts / Amps	Application	Code	Price
64260	Osram Sylvania	12V 30W	Various	24-BT00864	\$20.99
64250HLX	Osram Sylvania	6V 20W	Various	24-BT00861	\$5.99
64634HLX	Osram Sylvania	15V 150W	Various: Marco/Topcon/Zeiss	24-BT00931	\$11.99
EPN	GE	12V 35W	Various	24-BT01488	\$43.99



## Batteries

MFPN	Manufacturer	Volts / Watts / Amps	Application	Code	Price
72200	Welch Allyn	3.5V	Welch Allyn Nicad Rechargeable for Handle	24-BT02926	\$70.99
72200	W.A. Equivalent	3.5V	Welch Allyn Equivalent Nicad Rechargeable for Handle	24-BT39692	\$41.99
72000	Welch Allyn	2.5V	Welch Allyn Nicad Rechargeable for Otoscope Handle	24-BT16999	\$53.99
72000	W.A. Equivalent	2.5V	Welch Allyn Equivalent Nicad Rechargeable for Otoscope Handle	24-BT39691	\$41.99
72300	Welch Allyn	3.5V	Welch Allyn Nicad Rechargeable for Convertible Handle	24-BT17002	\$53.99
72300	W.A. Equivalent	3.5V	Welch Allyn Equivalent Nicad Rechargeable for Convertible Handle	24-BT39693	\$41.99
72600	Welch Allyn	2.5V	Welch Allyn Nicad Rechargeable for Power Handle	24-BT17004	\$84.99
72600	W.A. Equivalent	2.5V	Welch Allyn Equivalent Nicad Rechargeable for Power Handle	24-BT04846	\$26.99
360HOP	TD	3.5V	Equivalent Battery for Optec No. 360 Retinoscope	24-BT360HOP	\$43.99
224	TD	5.0V	Equivalent Battery for Marco/Mentor 22-4515 B.A.T.	24-BT0011625	\$78.99
191	TD	3.5V	Equivalent Battery for Keeler Battery # 1919P5020 Vista 20 Handle	24-BT0005258	\$50.99





# Surfacing



# AR Coating Consumables



Call for Current Pricing!



- High-purity minerals and compounds optimized for all AR coating technologies
- Compatible with all coating equipment and lenses

Item	Code	Unit
Titanium V Oxide (granule)	93-TI3O5	500g
Hafnium Oxide (tablet)	93-HFO2	1kg
Zirconium Dioxide - White (tablet)	93-ZRO2-W	1kg
Zirconium Dioxide - Black (tablet)	93-ZRO2-BK	1kg
Chromium (granule)	93-CR	1kg
Chromium Silicon Monoxide (granule)	93-CRSIO	1kg
Silicon Monoxide (granule)	93-SIO	1kg
Silicon Dioxide (granule)	93-SIO2	1kg
Aluminum Oxide (granule)	93-AL2SO3	500g
Magnesium Fluoride (granule)	93-MGF2	1kg
Indium Tin Oxide (granule)	93-ITO	1kg
Tin Oxide (granule)	93-SNO2	1kg
6 Mhz Quartz Crystal - Gold	93-6MHZQC-G	10 Crystals
6 Mhz Quartz Crystal - Aluminum	93-6MHZQC-A	10 Crystals
Filament Mark I - Tungsten	93-FM1	Each
Filament Mark II - Tungsten	93-FM2	Each
E-Beam Gun Filament - 7.5 Turns	93-EBGF	Each

# Alloy

Call for Current Pricing!



- Available in 117°F melting point
- Works in all alloy blocking machines
- 1 lb. bar

\*Call for assistance with other melting points.

23-A117-1LB



# Cad-Con 1000™

## Cadmium and Lead Stabilizer

- Treats alloy reclaim tank wastewater
- Stabilizes lead and cadmium from wastewater
- 4 oz. of Cad-Con 1000™ treats 5 gallons of alloy tank wastewater
- 8 lb. pail



Cad-Con 1000™ can also be used to treat other alloy-contaminated hazardous wastes such as block washer water, swarf sludge, coolants, polishes, and emery.

99-338-1 \$289.99



## The Original All Off Marking Ink Remover

Remove the Most Stubborn  
Progressive Ink Markings in  
Just 3 Seconds Flat!

Instantly dissolve and remove any progressive ink marking with the industry's most widely used solution. It is safer than acetone and will never ruin polycarbonate lenses. Our award-winning product is used by more labs than any other marking ink remover in the world.

- The industry standard for ink removal
- Acetone-free and safe on polycarbonate lenses
- No scrubbing; eliminates unwanted micro scratches
- Dries instantly; no oily residue

Easily Erase Progressive Ink Markings  
with Our Handy All Off Pen

The unique valve-action mechanism dispenses All Off to the ink-absorbing tip. Simply press down and rub away the most stubborn ink markings in just seconds.

16 oz.	99-AO	\$59.99
4 oz.	99-AO4	\$14.99
Pen	99-AOP	\$19.99

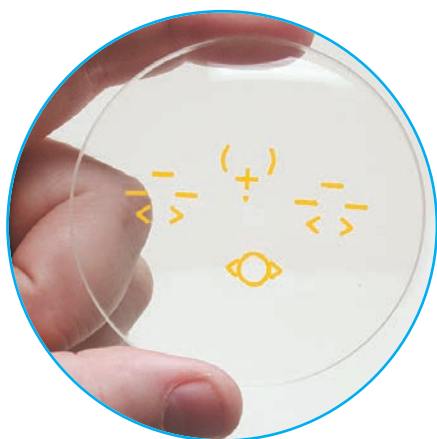

Before



After



# Spin-On UV-Hardcoat

## UV Curable Backside Spin Coating

Spin-On delivers guaranteed superior performance at a significant savings. Our solvent-free formula is both safe and effective.

- Compatible in all standard spin coater machines
- Superior scratch resistance and tintability
- Excellent adhesion to AR
- 4 oz.



99-SPINON \$399.99

## Conversion Kit

- One 5 micron coating filter
- One pair of gloves and safety goggles
- Two empty 4 oz. bottles
- Four feet of tubing for coating station
- One gallon size zip bag

99-SPINONCK \$79.95



# Chem Tempering Salts

- Produces a compressive stress in the lens surface
- Designed to work with any chem tempering equipment



\$59.99 each

2-Hour Photochromic	27-PHOTO2
16-Hour Photochromic	27-PHOTO16
16-Hour Crown	27-CROWN16

# Non-Silicone Defoamer

## Super Concentrated For Industrial Use

Our super-concentrated non-silicone defoamer is effective at knocking down foam in all recirculating processing systems. The absence of silicone aids in the acceptance of coatings.

- Super-concentrated
- 8 oz.



99-NSDF8 \$24.99



# Latex Gloves

No other glove feels and fits like natural rubber latex. Latex offers a perfect combination of strength, tactile sensitivity, barrier protection, and comfort.

\$9.99 each



- Powder-free
  - Box of 100
- Gloves measure:  
4.8 mil palm  
8.4 mil finger  
3.6 mil cuff



X-Large	99-LGXL
Large	99-LGL
Small	99-LGS

# Nitrile Gloves

Nitrile gloves offer better tactile sensitivity, comfort, dexterity, and puncture resistance than both latex and vinyl. These gloves are made stronger through a manufacturing process which integrates synthetic polymers to create a multi-layered glove for enhanced protection.

\$12.99 each



- Powder-free
- 5 mil thick
- Box of 100



X-Large	99-NGXL
Large	99-NGL
Small	99-NGS



Small Tray  
6" wide x 9" long x 1.5" deep

Large Tray  
7" wide x 12 1/4" long x 2" deep

## Small Job Trays

\$1.99 each

Self-nesting partitioned job tray comes with an adjustable divider.

## Large Job Trays

\$3.99 each

Dual partition separates left and right lenses, and lenses from frames. Rigid plastic offers reliable stacking, no warping, and a long life.

- Available in eleven different colors
- Self-stacking
- Sold 24 per case (1 color per case)

	BLACK	BLUE	BROWN	GREEN	GREY	IVORY	ORANGE	PINK	PURPLE	RED	YELLOW
Small:	69-101	69-102	69-103	69-104	69-105	69-106	69-107	69-108	69-109	69-110	69-111
Large:	69-201	69-202	69-203	69-204	69-205	69-206	69-207	69-208	69-209	69-210	69-211

## Job Tray Labels



Small Job Tray Label



Large Job Tray Label

\* Only available as Disposable

Disposable 120 Per bag

Small Job Tray 3 1/4"(W) x 1"(H) 51-JOBTRAYTAG1X3 \$4.99

Large Job Tray 2"(W) x 1"(H) 51-JOBTRAYTAG1X2 \$2.99

Rewritable 100 Per bag

Small Job Tray 3 1/4"(W) x 1"(H) 03-15.609 \$39.99

- Use any non-permanent marker

## Polish Off

### Job Tray Cleaner

Our innovative solution is the only formula proven to thoroughly clean dried polish from all job trays. Restores job trays to like-new condition.

- Simple spread on, wipe off process
- Helps eliminate scratched lenses
- Quart size



99-278-1 \$19.99

## Tape Dispenser System

Designed and tested to apply surface saver tape uniformly across ophthalmic lens surfaces by using air pressure.

- Eliminates manual application
- No electrical connection
- Requires 60 psi



08-3M1645    \$2,839.99

## Surface Saver Blades



- Sold in packs of 5

08-3M9944    \$79.99

## 3M Surface Saver Knife Blade Handle



- For use with 3M Surface Saver knife blades

08-3M9942    \$14.99

## 3M Clear Surface Tape

- Linerless clear tape for wax blocking
- 4" x 72 yards



08-3M1663    \$64.99

## Clear Surface Tape

- Economical tape for wax blocking systems
- Clear tape makes for easy layout
- 4" x 36 yards



51-SSTC    \$29.99

## Ceri-Guard 600 Linerless Surface Tape

This premium linerless surface tape is specially formulated to give extra heat reflection and surface protection while conforming to all lens surfaces including deep curves, lentics, and executives.

- Available in blue and green
- 4" x 76.5 yards

Double the Length



Blue	99-SSTLINERLESS	\$69.99
Green	99-SSTGLINERLESS	\$69.99

## Premium Surface Protection Tape

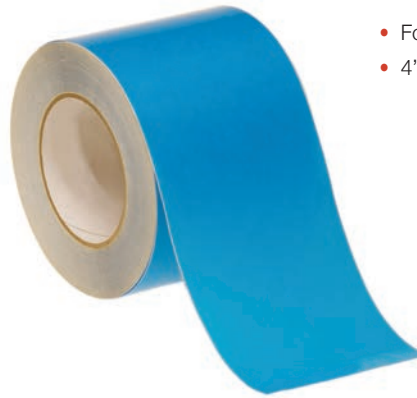

- For plastic lens applications
- 4" x 36 yards

51-SST \$29.99

## 3M Surface Saver II Tape



- 3M1641 for medium-temperature alloy blocking
- 3M1640 for high-temperature alloy blocking
- 4" x 50 yards

08-3M1641 \$44.99  
08-3M1640 \$44.99

## Economy Surface Protection Tape

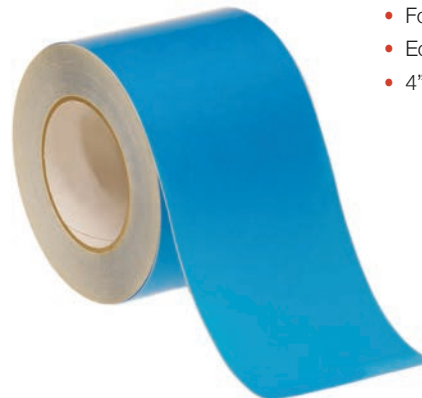

- For plastic lens applications
- Economically priced
- 4" x 36 yards

89-SST2 \$27.99

# Surfacing Pads - Shape Guide

As well as the traditional 6- and 7-petal surfacing pads, we offer a range of alternative pad shapes for different applications, such as high curve impellor pads.

All surface pad items and pricing refer to 76mm (3") 7-Leaf shape.  
All other shapes and sizes are available upon request.

**Q** 8 Leaf  
3"  
3.25"  
3.5"



**T** 7 Leaf  
3"  
3.125"  
3.25"  
3.5"



**P** 6 Leaf  
2.65"  
3"  
3.125"  
3.25"  
3.5"



## "Superfine" Black 1st Fine

A unique 1st fine pad, it gives consistent and high stock removal rates throughout the fining cycle, yet achieves an excellent surface finish for the 2nd fine stage. The flexible backing ensures excellent conformity to the tool.

MATERIAL: Silicone Carbide  
THICKNESS: 0.27mm  
SIZES: All sizes  
SHAPES: P,Q,T

500/Roll 89-A1D2N \$49.14



## Black Polycarbonate 1 Step

The Black Polycarbonate 1 Step has been developed for the discerning customer who is looking for minimal stock removal while achieving the best possible finish quality on Polycarbonate and Trivex lenses. It is produced to exceptionally high standards by selecting the finest grade abrasive grit and materials to produce the best finished result possible.

MATERIAL: Silicon Carbide  
THICKNESS: 0.46mm compensated  
SIZES: 76mm, 89mm  
SHAPES: P, T

500/Roll 89-E1D2C \$40.66



## Red 1 Step

The unique design and specification of the aluminum oxide particles ensures a high, consistent stock removal rate throughout the curve range and in all conditions while maintaining an excellent surface quality. Available with the special compensated backing which is the thickness of a 1st and 2nd fine pad combined, or as a non-compensated version.

MATERIAL: Aluminum Oxide  
THICKNESS: 0.27mm,  
0.47mm compensated  
SIZES: All sizes  
SHAPES: P, Q, T

500/Roll 89-D1D2C \$43.38



## Black 1 Step

The surface structure of the pad is designed to give excellent stock removal characteristics while maintaining a quality lens surface without extending polishing times. Available as a standard thickness or with the special compensated backing which is the thickness of a 1st and 2nd fine pad.

MATERIAL: Silicon Carbide  
THICKNESS: 0.27mm,  
0.47mm compensated  
SIZES: All sizes  
SHAPES: P, Q, T

500/Roll 89-D2D2C \$40.66



## Quantum 1 Step

This special abrasive is unique, giving the highest quality surface with minimum running times and providing an excellent foundation for AR coating. It is available with the special compensated backing or in the non-compensated version.

MATERIAL: Aluminum Oxide  
THICKNESS: 0.27mm,  
0.47mm compensated  
SIZES: All sizes  
SHAPES: P, Q, T

500/Roll 89-D3D2C \$37.46



## Hi-Index 1st Fine

The Black 1st fine Hi-Index pad is an evolutionary pad designed for use with modern generators with little or no elliptical error. The lower stock removal rates make it ideal for today's soft Hi-Index lens material.

MATERIAL: Silicon Carbide  
THICKNESS: 0.28mm  
SIZES: All sizes  
SHAPES: P, Q, T



500/Roll 89-A2D2N \$57.02

## "Superfine" Black 2nd Fine

Superfine is a more aggressive addition to our family of 2nd fine pads with increased stock removal rates. Consistent results ensure complete suitability on the full range of CR-39 and Hi-Index lens material. The specially formulated backing allows excellent conformity to the tool when placed directly over the 1st fine pad.

MATERIAL: Silicon Carbide  
THICKNESS: 0.26mm  
SIZES: All sizes  
SHAPES: P, Q, T



500/Roll 89-C1D2N \$68.64

## "Superfine" Pink 2nd Fine

This pad has been designed especially for use with the latest generation of processing equipment and plastic lens materials. The aluminum oxide abrasive is unique and requires no breakdown of the abrasive to achieve a high quality surface with minimum running times. For the best results, use a direct water supply running to waste.

MATERIAL: Aluminum Oxide  
THICKNESS: 0.13mm  
SIZES: All sizes  
SHAPES: P, T



500/Roll 89-C2D2N \$62.82

## 180 Grit Roughing

The 180 grit is a well tried extremely aggressive pad and is ideally suited for curve correction or removal of extreme elliptical error.

MATERIAL: Aluminum Oxide  
THICKNESS: 0.40mm  
SIZES: 76mm, 89mm  
SHAPES: P, T



500/Roll 89-B1D2N \$35.08

## 320 Grit Roughing

An aggressive Silicon Carbide material specifically designed as a superior first fine pad for polycarbonate lenses. It gives a consistent removal rate throughout the fining operation and leaves a regular surface for the next fining stage. This pad can also be used as a standard roughing pad for CR-39 and Hi-Index lenses with excellent results.

MATERIAL: Silicon Carbide  
THICKNESS: 0.40mm  
SIZES: 76mm, 89mm  
SHAPES: P, T



500/Roll 89-B2D2N \$55.48

## Merlin 1 Step Multiplex

The Merlin Multiplex pad is a natural progression from our original Wizard Pad, which was the first multipurpose one step pad to be developed for fining both polycarbonate and CR-39 materials. This one step pad does away with the multitude of pads found in most labs, eliminating the need to have different pads for different plastic lens materials.

MATERIAL: Silicon Carbide  
THICKNESS: 0.027mm,  
0.46mm compensated  
SIZES: 76mm, 89mm  
SHAPES: P, T



500/Roll 89-F1D2C \$35.00

## Performa Polishing

The Performa is a high performance plastic polishing pad which has been specially developed for today's demanding production and to complement the latest advancement in aluminum oxide organic lens polishes.

MATERIAL: Short flock synthetic  
THICKNESS: 0.70mm (compressed)  
SIZES: All sizes  
SHAPES: P, Q, T



250/Roll 89-G2D2 \$26.38



## Yellow Lustre Polishing

Yellow Lustre is the original benchmark for companies looking to buy the best possible high-end polishing pad on the market. The cotton twill backing and the uniform nap length give a firm pad with excellent curve reproduction capabilities. The Lustre is particularly suited for use after one-step fining and cut-to-polish operations on both CR-39 and Hi-Index lenses.

250/Roll 89-G3D2 \$26.90

MATERIAL: Short flock synthetic  
THICKNESS: 0.70mm (compressed)  
SIZES: All sizes  
SHAPES: P, Q, T



## Silver Polishing

The Silver Polishing pad is ideal for the customer looking for the balance between economy and quality. This polishing pad has specifically been developed for all types of machines and lens materials. The synthetic substrate backing and uniform velveteen nap give a firm pad with excellent curve reproduction capabilities.

250/Roll 89-G4D2 \$30.52

MATERIAL: Short flock synthetic  
THICKNESS: 0.70mm (compressed)  
SIZES: All sizes  
SHAPES: P, Q, T



## Sapphire Polishing

Sapphire's short synthetic nap allows for the maximum delivery of polish to the lens surface ensuring superb results. It also benefits from our unique backing and adhesive technology, making it suitable for use on all lap types, while absorbing any minor defects in the surface of the tool.

250/Roll 89-G5D2DC \$28.32

MATERIAL: Short flock synthetic  
THICKNESS: 0.70mm (compressed)  
SIZES: All sizes  
SHAPES: P, Q, T



## Rose Polishing

The Rose pad incorporates new unique flock length technology. The nap on this pad is very soft and flexible and not of a uniform length. It allows a far greater flow of polish to the surface of the lens and pad, dramatically increasing the amount of polish at the lens surface during the polish cycle. Rose is suitable for use with all types of lens materials and machinery but is especially suited for labs that run a high percentage of Hi-Index, polycarbonate, Trivex, and AR coated lenses. It provides outstanding results when run on the latest cut-to-polish equipment.

250/Roll 89-G7D2 \$34.06

MATERIAL: Short flock synthetic  
THICKNESS: 0.85mm (compressed)  
SIZES: All sizes  
SHAPES: P, Q, T



## Q 1 Step Multiplex

Q Multiplex pad allows the customer all the freedom of having only one pad in stock for handling all lens types, from simple CR-39 to polycarbonate and beyond.

500/Roll 89-F2D2C \$41.26

MATERIAL: Aluminum Oxide  
THICKNESS: 0.027mm,  
0.46mm compensated  
SIZES: 76mm, 89mm  
SHAPES: P, T



## White Polishing

This addition to our range of polishing pads was developed to be compatible with all lens materials, liquid polishes, and makes of machinery. Its balance between performance and cost makes this product the top choice for a great number of customers who are looking for exceptional value and good, consistent quality.

250/Roll 89-G1D2 \$25.16

MATERIAL: Short flock synthetic  
THICKNESS: 0.75mm (compressed)  
SIZES: All sizes  
SHAPES: P, Q, T



# Lens Polish

\$39.99 each



## Clarity Plus

- 1.1 micron particle size
- 23° Baume
- Best for polycarbonate polishing
- Gallon

50-CPP



## Polish All

- 1.7 micron particle size
- 23 - 25° Baume
- Econo-formula
- Gallon



50-PA \$29.99



## HA-1

- 2.0 micron particle size
- 24° Baume
- Universal formula is simple to use
- Gallon

50-HA1



## Americal Plus

- Rapidly removes stock on all lenses, regardless of curvature
- Excellent for hard resin, polycarbonate, and high-index lenses
- Ideal for AR and hard coatings
- 1.2 - 1.7 micron particle size
- 25 - 30° Baume
- Gallon

99-AMERICALPOL \$39.99



## V2100

- 2.2 micron particle size
- 23 - 25° Baume
- Less aggressive stock removal
- Gallon

50-V2100

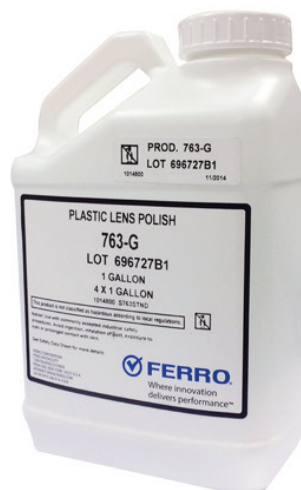

## Ferro 763

- Great on Polycarbonate and High-Index lenses
- Top high surface quality rating
- Can be used in both single bowl or central slurry systems
- 21 - 23° Baume
- 2.4 - 3.4 micron particle size
- Gallon

99-FERRO763 \$39.99

## Cylinder Machine Reception Chucks

Our replacement reception chucks fit all Satisloh® conventional cylinder machines. Made of a proprietary plastic, they offer extended longevity.

**\$199.99**  
each

- Sold by the individual chuck



### Loh Style

Left	91-ZELRCPL-LEFT
Right	91-ZELRCPL-RIGHT



### Gerber Style

Left	91-ZELGRCLPL
Right	91-ZELGRCRPL

## Plastic Fiberlite Laps

High-quality plastic laps will not warp over time. They do not produce dangerous fumes or odors when cut and allow for faster machining.

**\$7.99**  
each

- Can be cut on most 3-axis generators
- Engineered for superior curves and workmanship



Plano



6-Base Semi-Finished



2-Base Semi-Finished



8-Base Semi-Finished



4-Base Semi-Finished



10-Base Semi-Finished

Plano	06-DV-MAPSF	6-Base	06-DV-MA6SF
2-Base	06-DV-MA2SF	8-Base	06-DV-MA8SF
4-Base	06-DV-MA4SF	10-Base	06-DV-MA10SF

## Ball Cutters



3-Flute Ball Cutter  
For Polycarbonate



6-Flute Ball Cutter  
For Trivex,  
CR-39, Hi-Index  
and Polycarbonate



9-Flute Ball Cutter  
CR-39, Hi-Index  
and Polycarbonate



11-Flute Ball Cutter  
CR-39, Hi-Index  
and Polycarbonate



12-Flute Ball Cutter  
CR-39

3-Flute	99-3FLUTECUT	\$94.99
6-Flute	99-6FLUTECUT	\$94.99
9-Flute	99-9FLUTECUT	\$104.99
11-Flute	99-11FLUTECUT	\$94.99
12-Flute	99-12FLUTECUT	\$94.99
Ball Cutter Sharpening	99-BALLCUTRETR	\$49.99

We can sharpen your ball cutters until they reach 18.2 mm in diameter. Don't throw away your slightly used ball cutters! They can be sharpened up to 6 times.

## Generator Wheels

Manufactured to OEM Specifications

The diamond grit size, bond, and concentration are specifically selected for maximum performance and life. Concentricity is held to precise tolerances to ensure smooth operation.



See our full listing of generator wheels online

# Diamond Tooling

Our PCD tools are 100% made in the USA and will outlast lesser quality imported cutting tools. They are precision designed to fit your OEM equipment and provide a long cutting life.



## PCD Generator Blades / Milling Inserts

Coburn IQ	99-PCDBLADEIQ	\$159.99
LOH V-Pro Series (set of 8)	99-PCDBLADEPROV	\$1,449.99
Coburn DTL	99-PCDBLADEDTL	\$499.99
Schneider 12-Tooth Milling Tool Retip	99-SCHNEIDER12RT	\$1,599.99
Schneider 8-Tooth Milling Tool Retip	99-SCHNEIDER8RT	\$1,399.99
Satisloh 12-Tooth Milling Head Retip	99-PCDLOH12RT	\$899.99

## PCD Ball Mill Cutting Tools

- Fits 2G and Vista Generators

PCD Ball Mill Cutter	99-PCDBALLMILL	\$924.99
Retrue Ball Mill Cutter	99-PCDRETRUE2FL	\$449.99

## Single Crystal Diamond Cutter

- 2mm natural diamond

Schneider Generators	99-PCDDIAMOND1	\$579.99
LOH VFT Generators	99-PCDDIAMOND2	\$999.99

Are you using a new model generator? Is your equipment not listed here? Just give us a call for a prompt quote. We can retrue your worn cutters back to OEM specs.

# Revitalash<sup>®</sup>

COSMETICS

The Look of Ageless Beauty



See the full product line on pages 88-89

# Finishing





## 3M Leap Pads



3M Leap Pads are specially designed to meet all your edging needs. They offer superior adhesion, and they have two to three times the torque resistance of most blocking pads.



3M-1695  
24mm  
2,000 pads



3M-1696  
18mm  
1,000 pads



3M-1701  
24mm  
1,000 pads



3M-1700  
24mm  
2,000 pads



3M-1693  
18mm  
1,000 pads



3M-1712NR  
18mm  
1,000 pads



3M-1692  
26mm  
1,000 pads

## 3M Hydrophobic Pads

- Hydro specific pads
- Dual adhesive technology



3M-1707LSE  
18mm  
1,000 pads



3M-1708LSE  
24mm  
1,000 pads



3M-1712LSE  
18mm  
500 pads

08-3M1695	\$99.99
08-3M1696	\$69.99
08-3M1701	\$49.99
08-3M1700	\$89.99
08-3M1693	\$69.99
08-3M1712NR	\$79.99
08-3M1692	\$79.99

08-3M1707	\$179.99
08-3M1708	\$179.99
08-3M1712LSE	\$89.99

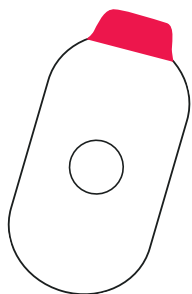

24 x 44mm

## 3M Anti-Slip Discs

For Hydrophobic Lenses

These clear film discs are 3M's solution to reduce slippage on hydrophobic coated lenses.

- 500 pads

08-3M1705	\$69.99
-----------	---------



35mm

## 3M Blue Chip Lens Protector

Protects Lenses During Edging

3M Blue Chip Lens Protector tape adheres to the center of the lens to protect against slippage and scratching from blocks and chucks. The transparent blue tape removes cleanly after use.

- 2,000 pads

08-3M1647	\$49.99
-----------	---------



# Blocking Pads

See pages 144-145 for ordering instructions



## Crimson King

The Crimson King pad material is constructed with a reinforced technology that resists high rotational forces and defies tearing. The modified acrylic adhesive bonds securely to all hard coated, standard AR coated and many hydrophobic AR coated lenses, then removes easily and cleanly.



## Cobalt King

The Cobalt King material is made from a unique high-density foam that has been used in aerospace and precision-industrial applications. The natural, rubber-based adhesive provides outstanding performance that has proven to be successful on hard coated and standard AR coated lenses. Works with some hydrophobic coated lenses.



## Economy Blue

Economy blocking pads combine a thicker foam pad material with a basic adhesive.



## SecurEdge

SecurEdge blocking pads have a unique foam substrate and proprietary adhesive. They provide dependable torque resistance on all hard-coated and standard AR coated lenses.



# Hydrophobic Blocking Pads

## SecurEdge Plus LSE

SecurEdge Plus LSE (Low Surface Energy) pads use a "dual-adhesive" system: One side of the pad has a high-tech LSE adhesive that bonds to the Hydrophobic AR coating, while the other side of the pad firmly grips the block.



## HydroKing

Our latest innovation offers our best solution for edging hydrophobic AR coated lenses.



# Selecting and Ordering Blocking Pads

## 1. Select Pad Shape from Opposite Page

## 2. Select Material



## 3. Select Quantity

	Crimson King	Cobalt King	Economy Blue	SecurEdge	Hydro King	SecurEdge Plus
Roll of 1,000:	\$59.99	\$49.99	\$44.99	\$59.99	\$99.99	\$129.99
Roll of 2,000:	\$114.99	\$94.99	\$84.99	\$114.99	\$194.99	\$254.99

### How to Order

Compose the product code:

1. Use the shape number found on page 145
2. Add the material code from above
3. Add a -2 for rolls of 2,000  
(Rolls of 1,000 do not require a quantity indicator)

### Sample Product Code

Note: All product codes start with **04-**

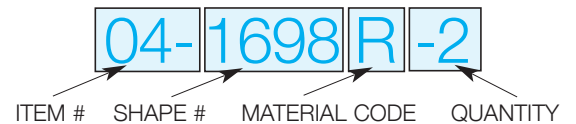

# Blocking Pad Shapes



FINISHING/EDGING

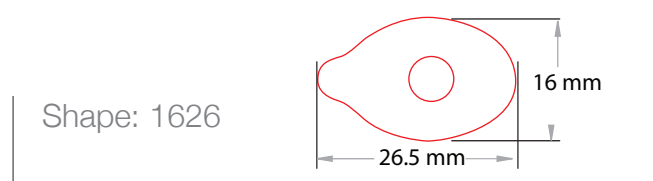
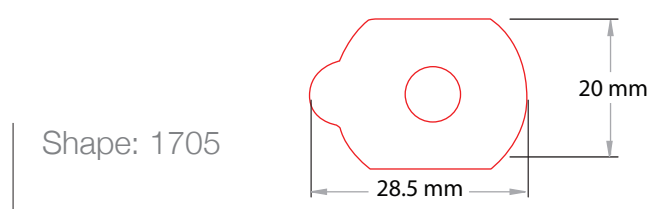
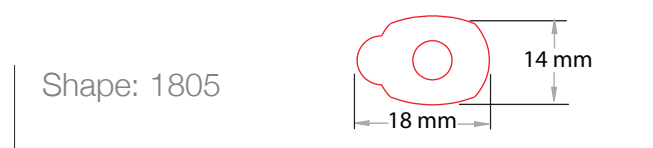
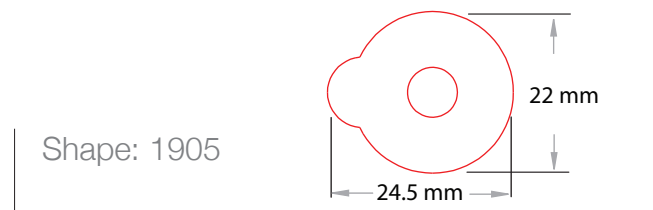
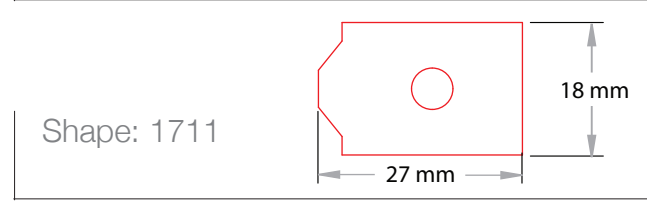
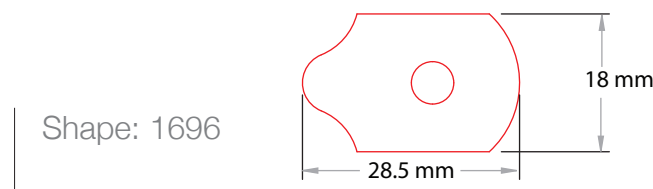
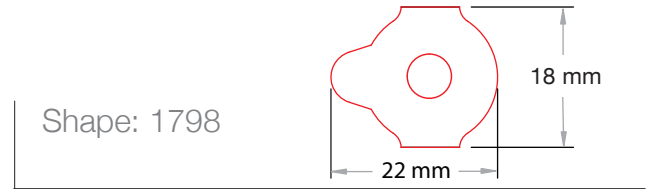
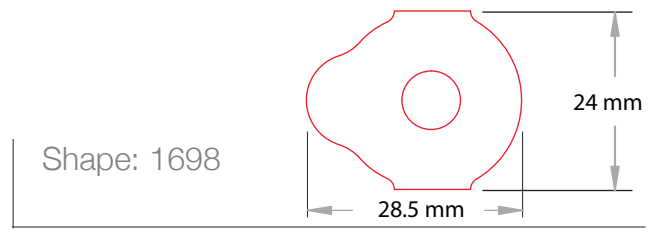
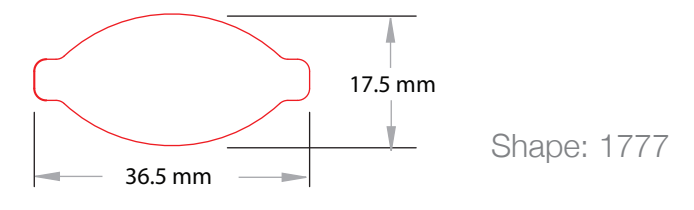
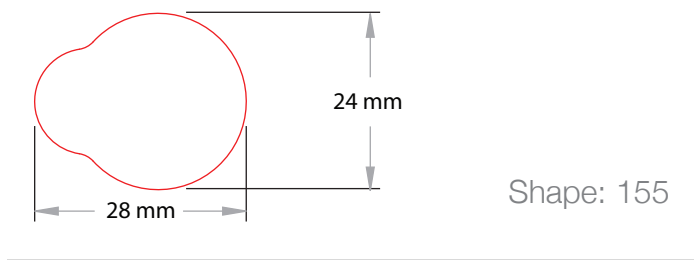
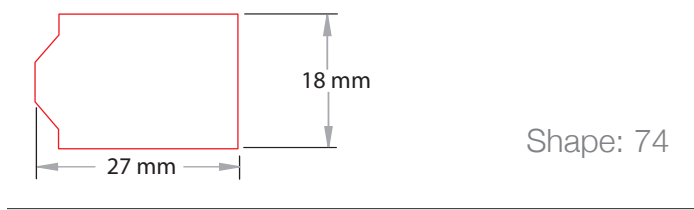
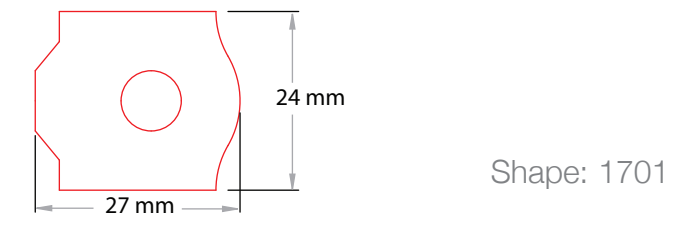
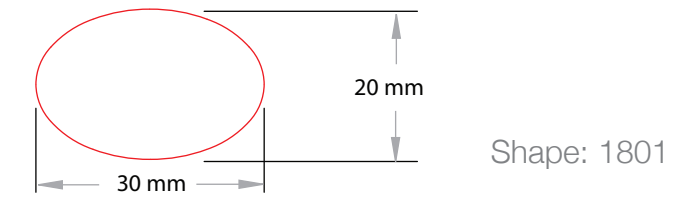
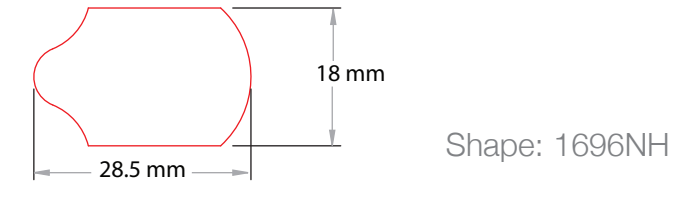

LENS CLEANER

CASES

ACCESSORIES

DISPENSING

OPTOMETRIC

SURFACING

FINISHING

TOOLS

FRAME PARTS

## Riki Film

The unique adhesive on the Riki Film bonds so effectively because it was created by the makers of hydrophobic coatings. This top-performing pad adheres to all slick top coatings.

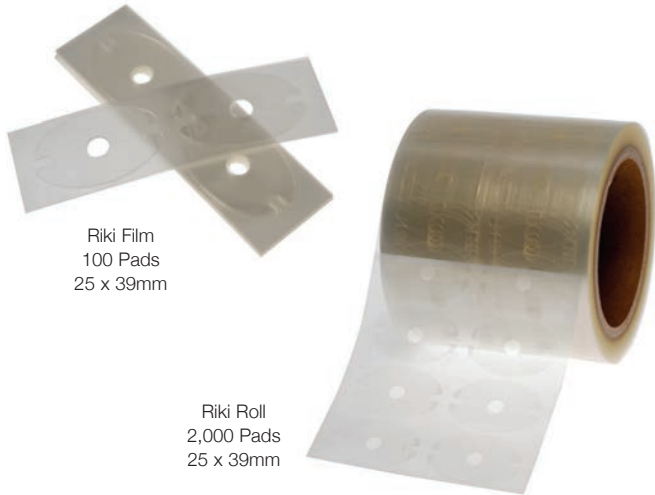

Riki Film	100	38-RIKIFILM	\$49.99
Riki Roll	2,000	38-RIKIROLL	\$679.99

## Riki 16 Blocking Pad

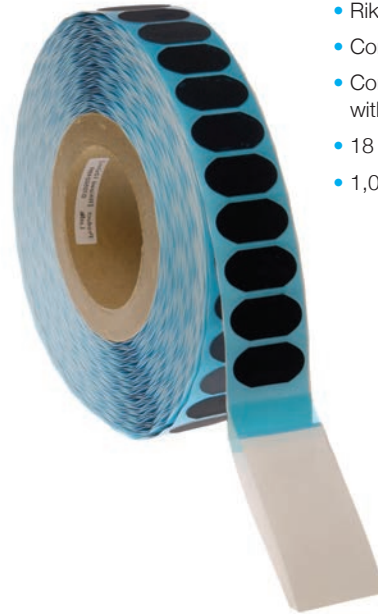

- Riki 16 hydrophobic blocking pad
- Converted for automatic blockers
- Combines the success of Riki film with a premium blocking pad
- 18 x 35mm
- 1,000 pads

38-RIK16PAD	\$399.99
-------------	----------

## Standard Lens Protection Discs

\$59.99  
per roll

Protect Your Non-Hydrophobic Coated Lenses from Scratches, Block Removal, and Chuck Pressure

\$39.99  
per roll

- Easy-lift tab
- Clean release leaves no adhesive residue
- Rolls of 1,000



Clear Oval  
04-OLP  
19mm



Clear Round  
04-CRLP  
39mm



Blue Oval  
04-BOLP  
19mm



Blue Round  
04-BTLP  
22mm



Round Chuck Pad  
04-FELTPAD2  
28mm  
(Sold in Rolls of 500)



Oval Chuck Pad  
04-FELTPAD  
20mm  
(Sold in Rolls of 500)



Blue Round  
04-BRLP  
39mm



Roll and Polish Pad  
04-70MMRPPAD  
70mm  
(Sold in Rolls of 500)

# Anti-Slip Solutions



\$199.99  
per roll

## Intermediary Film Pads (IFP)

Our IFP offers a lower-cost alternative to the Riki Film and features an easy-lift tab for quick removal.

- Use with OptiSource Blocking Pads to help eliminate slippage while edging hydrophobic jobs
- Features easy-lift tab
- Roll of 1,000

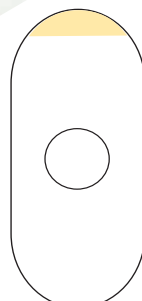

38-IFPSMALL  
18 x 40mm

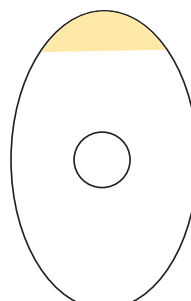

38-IFPLARGE  
28 x 40mm



## Super IFP

\$239.99  
per roll



38-SIFPSMALL  
18 x 40mm

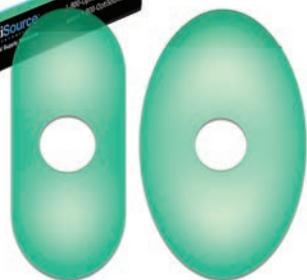

38-SIFPLARGE  
28 x 40mm

Our Super IFP has a specially formulated high-tack adhesive designed to grip to the smoothest, slickest, most oil resistant surfaces.

- Use to edge super hydrophobic and oleophobic coated lenses
- Easily removed and leaves no residue on the lens
- 1,000 pads

## Super Hydro Lens Anti-Slip Spray

Our spray-on technology is the advancement away from specialty blocking pads and lens protection discs.

Simply spray it on your slickest hydrophobic coated lens, let it dry, and apply any standard blocking pad.



4 oz.	99-SUPHYDRO	\$84.99
1 oz.	99-SUPHYDRO1	\$24.99

# Plastic Blocks

## Flexible and Rigid Materials

- Premium plastic compounds provide long life
- Performs like the first time, every time
- 25 blocks per bag

**\$2.79**  
each

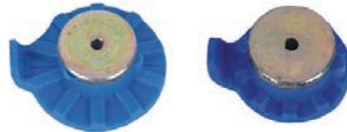

04-208A-25

04-208B-25

### Briot Universal Block Style

25mm	04-208A-25
19mm	04-208B-25



04-OS94

04-OS95

### Essilor Gamma Style

Full Eye Rigid Plastic	04-OS94
Half Eye Rigid Plastic	04-OS95



78-491

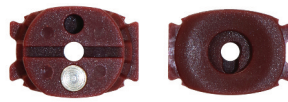

78-492

### Essilor Mr. Blue/Orange

Full Eye Rigid Plastic	78-491
Half Eye Rigid Plastic	78-492



04-OS92

04-OS93

04-OSNDK

### Nidek Style

9000 Full Eye Rigid Plastic	04-OS92
9000 Half Eye Rigid Plastic	04-OS93
9000 Oval Flexible Plastic	04-OSNDK



28-WFB

28-WFBH

28-WHB

28-WHBH

### Weco Style

Flexible Full Eye	28-WFB
Flexible Half Eye	28-WFBH
Rigid Full-Eye*	28-WHB
Rigid Half Eye*	28-WHBH

\*Designed for hydrophobic AR lenses



37-1002-A

37-1002-AH-17



37-1003-BBL

37-1003-BBL-17



37-1002-B

37-1002-BH-17

**\$1.59**  
each

### LOH Style Base-Specific

2.5 Base, Full Eye	37-1002-A
2.5 Base, Half Eye	37-1002-AH-17
3.5 Base, Full Eye	37-1003-BBL
3.5 Base, Half Eye	37-1003-BBL-17
6 Base, Full Eye	37-1002-B
6 Base, Half Eye	37-1002-BH-17

**\$1.99**  
each

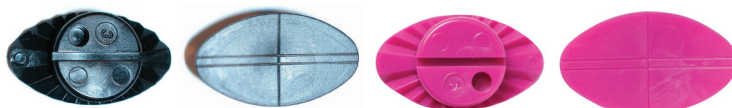

37-1007-B

37-1007-C

### Weco Style Base-Specific

3 Base, Oval	37-1007-B
5 Base, Oval	37-1007-C



37-1008-B

37-1008-BH-17

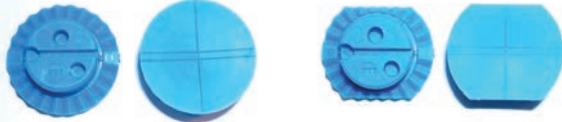

37-1009-B

37-1009-BH-17



37-1010-B

37-1010-BH-17



37-1011-B

37-1011-BH-17

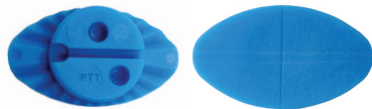

37-1014-B

### LOH Style Super Flex

Full Eye Flex	37-1008-B
Half Eye Flex	37-1008-BH-17
Full Eye, Solid-Back	37-1009-B
Half Eye, Solid-Back	37-1009-BH-17

\$1.79 each

### Weco Style Super Flex

Full Eye Flex	37-1010-B
Half Eye Flex	37-1010-BH-17
Full Eye, Solid-Back	37-1011-B
Half Eye, Solid-Back	37-1011-BH-17

\$1.79 each

### LOH Style Oval Flexible

Flexible Oval	37-1014-B
---------------	-----------

\$1.99 each

## Plastic Test Lenses

- For edger testing and calibration
- 50 lenses per box
- 70mm diameter
- 1.8mm thickness
- 6 base
- CR-39 material



99-CRTESTLENS \$39.99

## Deblocking Tools

\$34.99 each

### Deblocking Pliers

Remove blocks quickly and easily without damaging lenses.

- Small: 11mm diameter
- Large: 14mm diameter

Small	34-OSTHFDEBLS
Large	34-OSTHFDEBLL

### Angled Deblocking Pliers

The angled design decreases stress for safer deblocking on AR coated lenses.

34-OSTHFDEBLANG





## Edging Wheels

Our wheels perform well in every brand and style of edger, with any lens material, and for every purpose. We carry hundreds of roughing, finishing, beveling and hand-edging wheels.

### Roughing Wheels

All of our roughing wheels for polycarbonate, plastic, and high-index are made using our proprietary brazing technology, and provide a fast and aggressive cutting action and longer life than the OEM.

### Finishing Wheels

All of our finishing wheels are made to exact OEM specifications. Special orders or special profiles can also be custom-manufactured.

### Polishing Wheels

The high luster seen after using our polishing wheels cannot be beat.

### Hand Edger Wheels

OptiSource hand edger wheels are constructed to provide accurate beveling and easy touch-up work.

### Matched Wheel Sets

Two-wheel sets include a finishing wheel and a polishing wheel with the same profile/V-Bevel. Purchasing a set will reduce downtime by requiring less calibration.

Set Consists of One Finishing Wheel and One Polishing Wheel



Visit our website for a complete selection of edging wheels





## Hide-a-Bevel Hand Edger



Our newest design is built to provide you with years of hassle-free use. Our Hand Edger features a diamond wheel with 3 cutting surfaces: 100 grit, 240 grit, and V-Groove.

- Large water reservoir and swarf collector
- Vibration-free operation
- Ergonomically designed
- Clear safety shield

Power: 110V / 20W  
 Weight: 33 pounds  
 Dimensions (W x H x D):  
 12.25" x 17.75" x 13"

Replacement Wheel Dimensions:  
 150mm Diameter x 30mm Wide x 18mm Center Hole

\*To cut polycarbonate, remove the water reservoir and sponge

32-HANDEDGER	\$399.99
--------------	----------

Replacement Part:

Wheel	32-HANDEDGERWHEEL	\$89.99
-------	-------------------	---------

## FINISHING/EDGING

### Carbide Cutter Blades

Sold in sets of 2

**\$14.99**  
ea. blade

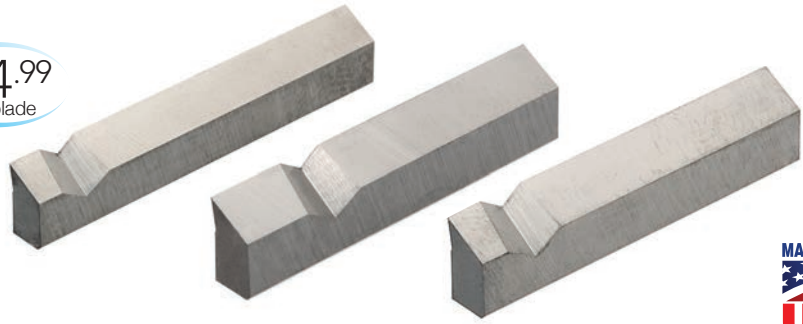

Horizon 2	99-HORIZON2
Horizon 3	99-HORIZON3
Horizon 6E	99-HORIZON6E
Horizon 7E	99-HORIZON7E

### PCD Cutter Blades

Our PCD blades are made in the USA and will outlast lesser quality imported cutter blades. They are precision designed to fit your OEM equipment to provide a long cutting life.

\*We also re-tip SatisLoh ES3 blades back to OEM specs.  
May be done up to 4 times before total replacement is necessary.



PCD Cutter Blade for Horizon	99-PCDCUTTERBLD	\$399.99
ES3/4 PCD Cutter Wheel Re-Tip	99-PCDRETIPES3	\$1,849.99

### Little Giant Submersible Pumps

Little Giant pumps may be used totally submersed or in-line (fed with pipe or hose). They are constructed of epoxy-coated die-cast aluminum, and the motors are oil-filled.

- Heavy duty pumps for water or coolant systems
- Epoxy-coated aluminum housing
- 6' cord



1/40HP 5.1PSI	99-LGP-2E-38N	\$99.99
1/15HP 7.5PSI	99-LGP-3E-12N	\$149.99
1/12HP 10.6PSI	99-LGP-4E-34NR	\$219.99

SPECS: 2E-38N	SPECS: 3E-12N	SPECS: 4E-34NR
100 watts	200 watts	210 watts
3/8" FNPT intake	1/2" FNPT intake	3/4" FNPT intake
1/4" MNPT discharge	1/2" MNPT discharge	1/2" MNPT discharge
1/40 HP motor	1/15 HP motor	1/12 HP motor
11.8' max. lift	17.3' max. lift	24.5' max. lift

### Truing Sticks

**\$4.99**  
each

Our dressing sticks bring new life to diamond wheels.

- Brown (coarse) stick quickly restores worn roughing wheels to like-new condition, reviving cutting action
- White (fine) stick dresses finishing wheels for like-new grinding



40-BTS



40-WTS

Ask about Retruing and Sharpening Service

#### Wheels

We will bring your V-bevel back to the OEM precision standard.

#### Horizon Cutter Blades

Your carbide cutter blades can be re-sharpened 3 times! Don't discard slightly used blades. We'll make them new again. Minimum of 6 per order.

Call your customer representative today to arrange for sharpening service.

## White Industrial Strength Defoamer



Are you having a persistent foaming problem? Our concentrated defoamer instantly knocks down any foam. Simply add to your edger or generator reservoir and watch your foam disappear.

- Stops foam in its tracks and prevents foam-overs
- Extremely concentrated: 1 capful defoams 5 gallons
- Water-soluble and biodegradable

Gallon	99-DFG	\$69.99
Quart	99-DFQ	\$29.99



## Pink Industrial Strength Defoamer

Persistent foaming problem? Simply add a few drops of our Pink Defoamer to your edger or generator reservoir and watch your foam disappear.

- Highly concentrated: 1 capful defoams up to 5 gallons of liquid
- Fully water-soluble
- Biodegradable

Gallon	99-PDFG	\$69.99
Quart	99-PDFQ	\$29.99



## Pattern Blanks

**\$29.99**  
per bag

Our universal Pattern Blanks are the easiest patterns you'll ever work with. They incorporate raised grids on one side and engraved grids on the other. The semi-rigid material makes for efficient cutting on any brand of machinery, or by hand.



Beige  
99-PB



White  
99-PBW

- Medium thickness (80 x 60mm)
- Easy to cut
- Easy to read
- Embossed lines
- 100 per bag

## Jumbo Green Pattern Blanks

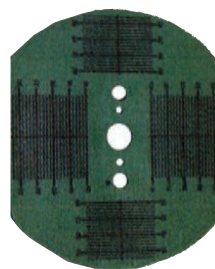

Green  
03-83.107

Our Jumbo Green Pattern Blanks are easy to cut, and the embossed measuring lines allow for easy size-matching.

- Smooth-cutting rigid plastic is 1/16" thick with reinforcing hub
- Good for use in automatic pattern makers
- 80 x 65mm
- 50 per bag

## Non-Silicone Defoamer

### Super Concentrated For Industrial Use

Our super-concentrated non-silicone defoamer is effective at knocking down foam in all recirculating processing systems. The absence of silicone aids in the acceptance of coatings.

- Super-concentrated
- 8 oz.

99-NSDF8	\$24.99
----------	---------



## Nu-Cool Coolant

Nu-Cool is environmentally friendly, chemically superior edger and generator coolant. Nu-Cool also eliminates foam-overs with its built-in defoamer!

- Performs well on plastic and glass
- Special detergent cleans out supply lines
- Prolongs the life of edger wheels
- Drain-safe and biodegradable
- Highly concentrated 80:1 ratio
- Performs when others fail

Gallon	99-COOL	\$69.99
Quart	99-COOLQ	\$24.99



## Poly Edge Glaze

Instantly Provides Glass-Clear Edges on Polycarbonate Lenses

Poly edges are cloudy after edging, but not anymore with OptiSource Polycarbonate Edge Glaze. Instantly produces a clear, finished look on edged polycarbonate lenses. Just wipe on and let dry.



- No machinery or buffing required
- Works instantly

8 oz.	99-PEG	\$59.99
1 Pen	99-PEGP	\$29.99

## “Big Stick” Polish Rouge

\$24.99 each

Our polishing compounds work for all lens materials. Use edge polish sticks to rapidly buff lens edges to a high luster. Huge 1 lb. bar.



CR-39 Polish Stick	71-BX-7057
Poly Polish Stick	71-BX-7058
High-Index Polish Stick	71-BX-7059

## Polishing Compounds



This economical and safe container keeps your hands clean and can be used to the last particle.

- White:** Final high gloss finish polishing compound for all plastic lens edges.
- Red:** Edge polish for glass lenses and metal frames. Water soluble.
- Yellow:** High gloss polishing compound for all plastic lens edges. Useful for index lenses.
- Blue:** First step compound favored by many for index materials. Use with solid felt buff and follow with finish compound for excellent results.
- Zam Green:** First step compound for all plastic lens edges. Good choice for index materials. Follow with finish compound.
- Wonder Bar:** Final step polish for use on both metals and plastics.
- Green:** First step compound for all plastic lens edges. Use with solid felt buff and follow with finish compound.
- Crystal Klear:** Excellent finish polish for clear and colored plastics of all types. Especially useful for ZYL.

White Rouge 5 oz.	03-47.326	\$6.00
Red Rouge 6 oz.	03-47.324	\$6.00
Yellow Rouge 5 oz.	03-47.327	\$6.00
Blue Rouge 4 oz.	03-47.322	\$6.00
Zam® (Green) 1lb. 2 oz.	03-47.503	\$10.00
Wonder Bar 4 oz.	03-47.328	\$5.00
Green Rouge 5 oz.	03-47.321	\$6.00
Crystal Klear 6 oz.	03-47.310	\$7.00

# Automatic Lens Edge Polisher



Universal Lens Chuck



Buffing Wheel



Electronic Controls

Simply insert the lens, set the timer, and our polisher automatically rotates the lens for a high luster finish.

- Fully automatic operation
- 5 different timer settings
- Polishes all lens materials
- Includes buffing wheel and polishing compound

Power: 110V / 140W  
Weight: 15 pounds  
Dimensions (W x H x D):  
8" x 9" x 12"

Replacement Buffing Wheel  
Material: cloth with copper center hole  
Diameter: 110mm  
Width: 20mm  
Center hole: 10mm

32-POLISHERAUTO \$429.99

Replacement Wheel  
32-POLISHWHEEL \$14.99



CE

See page previous page for polishing compounds



## Double Spindle Bench Polisher

This high-powered double spindle bench polisher features a sturdy design, and an easy-clean plexiglass shield. Heavy duty rubber feet assist in vibration-free operation.

Replacement Buffing Wheel  
Material: cloth  
Diameter: 120mm  
Width: 20mm  
Center hole: 10mm

32-POLISHERHAND \$239.99

Replacement Wheel  
32-POLISHWHEEL2 \$14.99

# Buffing Pads

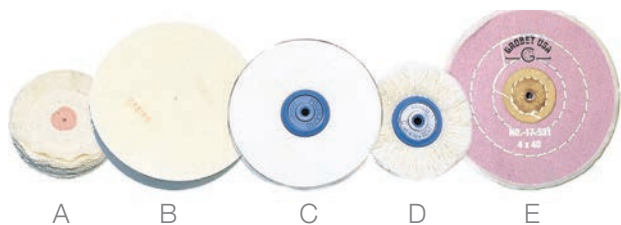

## Dixcel Flannel Buffs

### A Cotton Flannel

Soft cotton flannel produces a high polish when used with rouge. Well-stitched with shellac centers.

Dia.	Ply	Code	Price
3"	30	03-17.203	\$6.99
4"	30	03-17.205	\$7.99
5"	30	03-17.206	\$9.99
6"	30	03-17.207	\$10.99

## Felt Buff

### B Solid Felt

Highest quality wool felt, carefully compressed and formed for uniform texture, hardness and shape. Ideal for the first step of lens edge polishing.

Dia.	Ply	Code	Price
3"	1/2"	03-17.429	\$11.99
3"	Knife Edge	03-17.498	\$12.99
3"	1"	03-17.431	\$16.99
4"	3/4"	03-17.436	\$20.99
4"	1"	03-17.437	\$24.99
5"	2"	03-17.438	\$58.99
6"	1"	03-17.439	\$46.99
6"	1/4" Ctr hole 3/4"	03-17.440	\$14.99

### C Fine Soft Felt

6-ply with plastic center. A delicate touch and white rouge can remove hairline scratches from lenses before coating. High gloss final lens edge polishing with white rouge.

Dia.	Ply	Code	Price
3-1/2"	1/2"	03-17.130	\$14.99

## Yarn Buff

### D Woven Yarn

Light touch for final polish. Produces extra high gloss on lens edges, especially polycarbonate, high-index and CR-39. Strands of cotton yarn are woven into a solid plastic center. Will not fray or burn lens edges.

Dia.	Ply	Code	Price
3-1/2"	3/4"	03-17.213	\$14.99

## Berry Buff

### E Muslin

Stiff chemically treated fine-weave muslin. Good for polycarbonate and high-index edge polishing.

Dia.	Ply	Code	Price
4"	40	03-17.531	\$10.99



## Muslin Buffs

### F Dixcel Unbleached Muslin

Coarse, unbleached muslin. For cutting and preparing metals for fine finish. With three rows of stitching.

Dia.	Ply	Code	Price
3"	35	03-17.577	\$6.99
4"	42	03-17.581	\$5.99
6"	50	03-17.588	\$9.99

### G Super Buff

100% cotton, specially treated to make the cloth finer and virtually lint-free. Lasts up to 50% longer. With 4 rows and shellac centers.

Dia.	Ply	Code	Price
3"	50	03-17.704	\$9.99
4"	60	03-17.706	\$15.99

### H Dixcel Extra Fine

Fine, high-grade muslin with combed edges and hardened shellac centers.

Dia.	Ply	Code	Price
3"	35	03-17.622	\$6.99
4"	50	03-17.624	\$7.99
5"	55	03-17.625	\$10.99

### I Dixcel Yellow "Treated"

Chemically treated, coarse, unbleached high-grade muslin with combed edges to resist fuzzing. Shellac centers.

Dia.	Ply	Code	Price
4"	40	03-17.553	\$6.99
5"	45	03-17.554	\$6.99
6"	50	03-17.555	\$9.99

### J Dixcel Plastic Centers

Loose, unstitched, fine-grade muslin. Use with rouge for a high luster finish.

Dia.	Ply	Code	Price
4"	36	03-17.719	\$7.99
5"	54	03-17.721	\$9.99

### K Dixcel Leather Centers

Fine-grade muslin, loosely sewn, with leather centers to provide a firm grip on spindles.

Dia.	Ply	Code	Price
5"	45	03-17.755	\$8.99
5"	50	03-17.759	\$8.99
6"	50	03-17.756	\$10.99

# Automatic Lens Groover



CE

This fully automated lens groover creates precision grooves. The grooving blade is safe for use on plastic, glass, and polycarbonate lenses. The depth of the groove is easily adjustable from 0 to 0.7mm.

- Ideal for grooving semi-rimless lenses
- Accurate, adjustable groove depth
- Adjustable groove position
- High speed 5,000 rpm motor ensures clean cutting on all materials with minimal sound
- Spare parts available: belt, chucks, blocks, springs, pins, and sponges

32-GROOVERAUTO \$369.99

#### Replacement Parts:

Belt	32-GROOVERBELT	\$9.99
Standard Blade	32-GROOVERBLD-A	\$19.99
Premium Blade	32-GROOVERBLD-G	\$24.99
Poly Diamond Blade	32-GROOVERBLD-P	\$22.99
Spare Parts Kit*	32-GROOVERPARTS	\$69.99

\*Does not include blades



Universal Lens Chuck



Groove Depth



Precision Blade

Power: 110V / 90W  
Weight: 6 pounds  
Dimensions (W x H x D):  
6.75" x 6" x 8.5"

Blade dimensions:  
Diameter: 25mm  
Thickness: 0.55mm  
Center hole: 5mm



# Polarized Plano Lenses

With Backside AR Coating

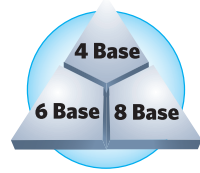
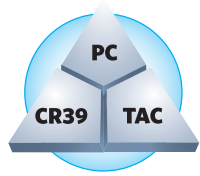

### How to Order

1. Build item number beginning with **99-343**
2. Add material code:  
**TAC: 01, PC: 02, CR-39: 03**
3. Add color code: **See color codes listing**
4. Add base curve code:  
**4 base: 04, 6 base: 06, 8 base: 08**

### Sample Product Code

For TAC, Copper, 8 base: 99-343-010408

99-343	-01	04	08
Item #	Material Code	Color Code	Base Curve

### Color Codes

Gray	01
G15	02
Brown	03
Copper	04
Dark Gray	05
Gray Gradient	06
Brown Gradient	07
Gray/Silver Flash Mirror	08
Brown/Silver Flash Mirror	09

## TAC (Tri Acetate Cellulose)

**\$9.99**  
per pair

- Lightweight, ultra-thin lens with higher clarity than polycarbonate
- Made with Japanese polarizer film and optical quality coatings
- Impact resistant and easy to edge on standard equipment

### Size Chart

Base Curve	Size (mm)	Thickness (mm)
4	54 x 72	1.0
6	54 x 72	1.0
8	54 x 72	1.0



Gray



Gray Silver Mirror



Brown Silver Mirror



G15



Gray Gradient



Brown Gradient



Brown



Dark Gray



Copper



# CR-39

\$23.99  
per pair

- Highest clarity and lowest distortion of all plastic lens materials
- Cast with PPG monomer for true ophthalmic quality

Size Chart		
Base Curve	AB Size (mm)	Thickness (mm)
4	72 x 60	2.0
6	76 x 60	2.0
8	76 x 60	2.2



Gray



Gray Silver Mirror



Brown Silver Mirror



G15



Gray Gradient



Brown Gradient



Brown



Dark Gray



Copper

# Polycarbonate

\$19.49  
per pair

- Shatterproof, scratch resistant lenses perfect for sports and children
- Mitsubishi polycarbonate material laminated with the highest quality polarized filter

Size Chart		
Base Curve	Size (mm)	Thickness (mm)
4	75 x 60	1.9
6	75 x 55	1.9
8	75 x 55	1.9



Gray



Gray w/Silver Mirror



Brown w/Silver Mirror



G15

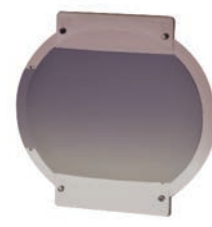

Gray Gradient



Brown Gradient



Brown

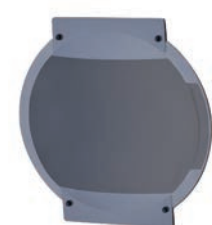

Dark Gray



Copper

# Free Overnight Shipping

on Hundreds of Finished Single Vision Brands, Materials, and Coatings



## Speed.

### *Fast Delivery*

FREE overnight shipping on orders over \$75.00 and \$5.99 overnight shipping for all other orders.



## Simplicity.

### *Easy-to-Use Website*

Quickly find and order lenses from hundreds of brands, materials, and coatings.



## Support.

### *Customer Service*

Friendly and knowledgeable team members are always ready to assist you via phone or email.



1-800-363-2424

[sales@optilenses.com](mailto:sales@optilenses.com)

## Digital Hot Air Frame Warmer

We've taken our top-selling adjustable temperature frame warmer design and outfitted it with a digital controller and temperature monitor. The bright LED screen displays the actual temperature inside the housing and the latest working temperature upon restart.



Temperature range: 104°F – 302°F  
 Power: 110V / 800W  
 Weight: 3 pounds  
 Dimensions (W x H x D):  
 3.5" x 6" x 11.5"

32-WARMERDIGITL \$229.99

## Salt Pan Frame Warmer

Quickly achieves optimal temperature, yet stays cool to the touch.



- Quick heating
- Compact size
- Safe and reliable

Temperature range: Up to 400°F  
 Power: 110V / 300 Watts  
 Weight: 4 pounds  
 Dimensions (W x H x D):  
 10.5" x 4.5" x 5"



99-W2500 \$209.99

## Hot Air Frame Warmer

This warmer has a temperature knob that allows for adjustment from 130° to 230°F. Place the frame in the cup and direct heat where you need it.



Temperature range: 130°F – 230°F  
 Power: 110V / 600W  
 Weight: 3 pounds  
 Dimensions (W x H x D):  
 3.5" x 6" x 11.5"

32-WARMERSTNDRD \$199.99

## Glass Beads

These beads transmit heat evenly to the frame. Unlike salt, our glass beads will not lodge in lens grooves or frame parts.

- Useable with any Salt Pan Frame Warmer
- 5 lb containers
- Replace beads every six months for optimal performance



Small (725 micron)	99-OSSGB	\$24.99
Large (2.5mm)	99-OSLGB	\$49.99



# Color-Stabilized Lens Dyes

\$6.99 each

Long-Lasting Dyes Provide Bright and Consistent Colors

## Customer Favorite Colors



OptiSource is a leader in the optical tinting industry, using cutting-edge technology to produce chemically superior dyes. The use of dye-stabilizing chemistry produces fast-absorbing dyes that provide consistent colors from bottle to bottle and lens to lens.

- Consistent no-shift colors
- Non-toxic and biodegradable
- 4 oz. concentrate (makes one quart)



## Additional Colors



# DyeMaster PRO 9-pan Tinting System

High-Performance, High-Production Tinting



Digital controlled system actively monitors temperature and continually adjusts power output to ensure perfect tints. Eliminate boil-overs by controlling the temperature to precise standards.

- High quality stainless steel
- Digital controls

Power: 120V / 1500W  
Weight: 28 pounds  
Dimensions (W x H x D):  
23" x 14" x 15"

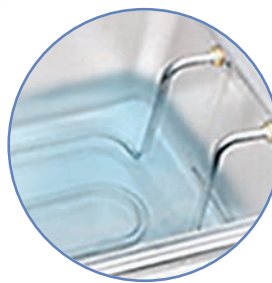
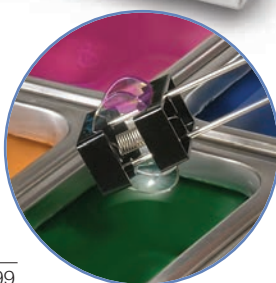

Tint unit with pans	99-TINTUNITPRO	\$999.99
Base only (no pans)	99-TINTUNITB	\$799.99

## Gradient System

Digitally controlled dipping mechanism allows for stable, non-repeating strokes that eliminates hard lines. Telescoping arm and optional weighted base allows the mechanical gradient to be used with any tint system.

- Provides smooth, no-line gradients
- Achieve soft gradients with the press of a button
- Easy-to-use dipping mechanism: set it and forget it

Power: 120V / 120W  
Weight: 7 pounds  
Dimensions (W x H x D): 6" x 18" x 7"

99-GRADIENT	\$419.99
99-GRADIENTBASE	\$49.99

\*Lens holder and weighted base not included



## Tint Pans and Lids

Two pint-size pans fit into the space of one quart-size pan to double tint capacity. Lids come with a heat-resistant knob for your safety.

- Heavy-duty, stainless steel construction
- Non-corroding
- Pint or quart size



Quart Pan and Lid  
Fits 6 3/16" x 3 1/2" opening



Pint Pan and Lid  
Fits 3 1/2" x 3 1/2" opening

### Quart

Pan	99-HDTP	\$14.99
Lid	99-HDL	\$9.99

### Pint

Pan	99-HDTPM	\$19.99
Lid	99-HDLM	\$9.99

## Lens Holders

**\$19.99**  
each

End the confusion and frustration of cross-contaminating your dye colors. Use white lens holder for UV and neutralizer solutions, and black for all of your dye colors.

- Holds lenses with a tension grip
- Compatible with gradient systems



Black 99-LH2

White 99-LHW2



## Nu-Kote Hot Dip Scratch Coat

This revolutionary hot-dip scratch coating is applied just like tint and bonds within the pores of the lens.

- Improve lens hardness in just seconds
- Easy to use; no special machinery necessary
- Simple dip-and-rinse process

Gallon	99-SK	\$59.99
Quart	99-SKQ	\$19.99

## Cold Dip Scratch Protectant

It's much harder to scratch lenses when dirt, dust, and debris won't stick! No heating or special machinery necessary.

- Simple dip-and-rinse process at room temperature
- Instantly applies a super-slick coating
- Quart



99-HDCDSK	\$59.99
-----------	---------



## Lens Prep

Lens Prep cleans and preheats the lens. The open pores on preheated lenses quickly and evenly absorb dye and UV. Can also be used cold.

- Preheats and cleans the lens
- Reduces tinting and UV treating times
- Improves tinting consistency

Gallon	99-LPG	\$59.99
Quart	99-LPQ	\$19.99

## Piña Colada Lab Fresh

Our scented solution will mask the worst chemical smells with fresh, light aromas.

- A few drops does it all
- No more chemical odors in your lab
- Use in tint units and recirculating systems
- 8 oz.



99-PCF	\$19.99
--------	---------



## Heat Transfer Fluid

With Built-in Corrosion Inhibitors

Our HTF is completely odorless and biodegradable, making it safe for the user and the environment. Plus, it prolongs the life of your tint machine with its corrosion inhibitor chemistry.

- Biodegradable
- Self-cleans with special dye neutralizers – fluid stays clean longer
- Change HTF every six months for optimal performance

Gallon	99-HTF	\$69.99
Quart	99-HTFQ	\$24.99
Battery Operated Siphon Pump	99-SP	\$19.99



## Nu-Tralizer

Safely Remove Tint from All Lenses

An odorless neutralizing compound that reduces and removes tint from CR-39, high-index, polycarbonate, and Trivex® without compromising any hard coatings.

- Safe against streaking and crazing on all lens coatings
- Biodegradable

Gallon	99-NUT	\$69.99
Quart	99-NQ	\$24.99



## CR-39 Nu-Tralizer

Fast-Acting Formula

Rapidly remove tint from CR-39 and high-index materials. Dark colors or old lenses are no problem.

- Unique self-cleaning formula
- Biodegradable

Gallon	99-CR	\$69.99
Quart	99-CRQ	\$24.99



## Water-Based Nu-Tralizer

Water-Based Nu-Tralizer is our safest solution for tint removal. Feel confident using it on all lenses and coatings.

- Biodegradable
- 8 oz. concentrate (makes one quart)

99-NUTH2O	\$11.99
-----------	---------

## Dry Dye Packet

\$6.99 each

Fast-dissolving dry packets replace messy bottles of dye. Simply drop a packet of dye into water and watch it dissolve into a concentrated dye bath.

- Stores easily
- No mess
- Each packet makes one quart



## UV Dyes

\$24.99 each



UV treat and tint in one simple process. The same great dye colors you have grown to love with UV protection built in. Available in select colors.

- Blocks up to 100% UV at 400 nm
- 4 oz. concentrate (makes one quart)



## Lens Display Book

Showcase Fashion Colors or Coatings



\*Lenses not included

- Display holds 18 lenses
- Stores easily
- Lenses are easy to remove and replace

99-OSLDB \$49.99



# PolyDye Plus

\$29.99  
each



Finally, Tint Polycarbonate as Easily as CR-39

Our exclusive dye-stabilizing technology allows for consistent results on polycarbonate lenses. Special pH buffers allow for longer lasting, truer colors. PolyDye Plus will also work twice as fast on CR-39 and high-index materials. Available in a range of colors to satisfy all of your polycarbonate tinting needs.

- Achieve sunglass densities in just minutes on poly and seconds on plastic lenses
- Finally, true sunglass colors on polycarbonate lenses
- Safe to use on CR-39 and high-index
- Lasts longer than standard dyes
- 4 oz. concentrate (makes one quart)

## PolyDye Plus Colors



# BPI® Lens Dyes

\$7.99  
each



BPI® dyes have a distinctive chemical structure that provides superior stability and reduces tinting time significantly. During the tinting process, tint molecules will bond to the lens and become part of its structure.

- Choose from a wide variety of colors
- 3 oz. concentrate (makes one quart)

## Popular Colors



Yellow  
(31500)  
05-YELLOW



Amber  
(20601)  
05-AMBER



Orange  
(31700)  
05-ORANGE



Rosetone  
(21000)  
05-AOROSOTONE



RS Rose  
(44902)  
05-RODNSTKROSE



Lavender  
(45700)  
05-LAVENDER



Violet  
(31600)  
05-VIOLET



Green  
(31200)  
05-GREEN



G-15  
(49900)  
05-G-15



Blue  
(31300)  
05-BLUE



Pink  
(31400)  
05-PINK



Silor Mulberry  
(22200)  
05-MULBERYSILOR



Red  
(31900)  
05-RED



Diamond 500  
(37604)  
05-DIAMOND500



Sahara  
(21100)  
05-AOSAHARA



Absolute Brown  
(31105)  
05-ABSOLUTEBRN



Ultra Brown  
(31107)  
05-BPI31107



Brown  
(3100)  
05-BROWN



Swiss Chocolate  
(34300)  
05-SWISCHOCOLATE



Autumn Brown  
(26500)  
05-AUTUMNBROWN



Turbo Brown  
(37899)  
05-BPI37899



Ultra Gray  
(31106)  
05-BPI31106



Gray  
(31000)  
05-GRAY



Sun Gray  
(34000)  
05-SUNGRAY



Turbo Black  
(37900)  
05-BPI37900



Black  
(46300)  
05-BLACK



Jet Black  
(48801)  
05-JETBLACK



Absolute Black  
(46305)  
05-ABSOLUTEBLK

\* All Standard BPI colors are available.

## Milky Way UV



Milky Way is the world's only white UV solution. This special white formula is clearer than any other UV. Guaranteed to be the clearest UV you've ever used or your money back.

- AR-compatible – will not yellow, even after lens is AR coated
- Unique white UV formula makes it impossible to yellow any lens
- Provides 100% protection at 380 nm
- 8 oz. concentrate (makes one quart)

99-MWUV \$69.99

## Ultra Kote UV



Combines UV and scratch-coat protection into one simple process with no baking or curing required.

- Produces a clear, UV-protected lens with improved scratch resistance
- 8 oz. concentrate (makes one quart)

99-UKUV \$79.99

## Clean & Clear Ultra Kote UV



Totally crystal-free UV formula. This non-clumping UV solution stays cleaner in the pan and looks clearer on the lens.

- UV with scratch-coat combination
- Lasts longer and reduces crystals
- 8 oz. concentrate (makes one quart)

99-CCUKUV \$79.99



## Clear Eclipse UV



Clear Eclipse is powderless! The most advanced all-around UV formula available today...a non-clumping, fast-acting solution.

- Blocks 100% of UVA and UVB to 400 nm
- Our best-selling UV formula
- 8 oz. concentrate (makes one quart)

99-CEUV \$69.99

## Clean & Clear UV



This UV will not clump or crystallize in the pan. Eliminates popping and spattering for a safer work area. Rinses clean to produce incredibly clear lenses.

- Powderless in the bottle, powderless in the pan
- 8 oz. concentrate (makes one quart)

99-CCUV \$69.99

## Latex Gloves

**\$9.99**  
each

No other glove feels and fits like natural rubber latex. Latex offers a perfect combination of strength, tactile sensitivity, barrier protection, and comfort.



Gloves measure:  
4.8 mil palm  
8.4 mil finger  
3.6 mil cuff

- Powder-free
- Box of 100

X-Large	99-LGXL
Large	99-LGL
Small	99-LGS

## Nitrile Gloves

**\$12.99**  
each

Nitrile gloves offer better tactile sensitivity, comfort, dexterity, and puncture resistance than both latex and vinyl. These gloves are made stronger through a manufacturing process which integrates synthetic polymers to create a multi-layered glove for enhanced protection.



- Powder-free
- 5 mil thick
- Box of 100

X-Large	99-NGXL
Large	99-NGL
Small	99-NGS

## Lens Edge Pens

**\$34.99**  
each

Our Lens Edge Pens are the ideal product for finishing the edges of polarized lenses, especially on high minus work. They give a neat, finished look to the otherwise unsightly laminated edge. Our pens are also especially useful for adding a hint of color on rimless work, as well as minimizing edge thickness on lenses in full frames.



- The perfect solution to finish polarized lens edges
- Add a hint of color to rimless work
- Hides lens edge thickness in full frames

Black	99-LP-BLACK
Blue Mist	99-LP-BLUEMIST
Bordeaux	99-LP-BORDEAUX
Brown	99-LP-BROWN
Dark Brown	99-LP-DKBROWN
Fuchsia	99-LP-FUCHSIA
Gray	99-LP-GRAY
Lilac	99-LP-LILAC
Turquoise	99-LP-TURQUOISE
Violet	99-LP-VIOLET

## “Jimmy” Hand Cleaner and Dye Remover



“Jimmy” will quickly become your best friend in the lab. This micro-grit cream will gently clean dye stains from hands, clothes, and tint pans.

- 1 lb jar

99-J	\$24.99
------	---------

# 3-in-1 Lens Inspection Station

PAL Identifier, Polariscope, and Final Inspection Lamp

The Lens Inspection Station is a first-of-its-kind, three-in-one machine that includes a PAL Identifier, Final Inspection Lamp, and a Polariscope. It features an easy to use compact design and LED light sources that eliminate bulb replacement.

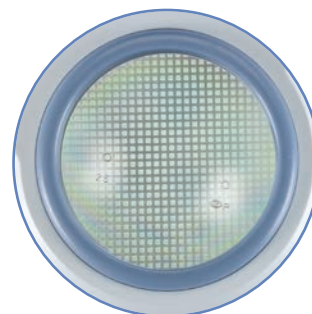

- PAL Identifier (black and white grid)
- Brings "invisible" PAL markings into focus

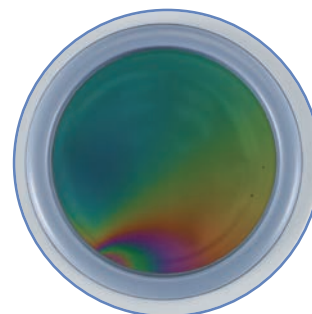

- Polariscope (grey tinted lens) reveals areas of the lens that have fitting stress
- Allows user to identify tempered glass lenses



- Final Inspection Lamp (clear lens)
- White light allows user to identify any abnormalities in the finished eyewear



Adjustable base for ideal viewing angle

32-LIS

\$299.99

LENS CLEANER

CASES

ACCESSORIES

DISPENSING

OPTOMETRIC

SURFACING

FINISHING

TOOLS

FRAME PARTS



## Lens Marking Pens

These fine-point pens make lens marking a cinch. Select a pen and color to suit your needs.

**\$3.99**  
each

**\$3.49**  
each

For AR Coatings

Red 55-319F-2  
Black 55-319F-9

For Non-AR Coatings

Red 55-313-2  
Black 55-313-9

\*Effective on hydrophobic coatings

## Stay Wet Marking Ink



Oil-Based Formula

**\$19.99**  
each

Standard water-based marking inks evaporate and dry out in the lensometer marking pin sponge. Stay Wet's oil-based formula keeps sponges saturated for reliable and bright markings every time.

- Dispenser bottle
- 10mL



Red 99-366-22111  
Black 99-366-22112  
Blue 99-366-22113  
Yellow 99-366-22117

## Lens Marking Ink II

Our advanced ink formula resists drying-out and produces brighter markings. Lens Marking Ink II is designed for lensometers, focometers, layout markers, or any other water-soluble ink application.

**\$4.99**  
each

- Water soluble
- High visibility
- Dispenser bottle
- 1 oz.



Red 99-260-1  
Black 99-260-2  
Blue 99-260-3  
Yellow 99-260-4



## Lens Marking Ink

Lens Marking Ink leaves a sharp impression when used with lensometers, focometers, or layout markers.

**\$5.99**  
each

- Water soluble
- High visibility
- 2 oz.



Yellow 99-OSMIY  
Red 99-OSMIR  
Blue 99-OSMIBL  
Black 99-OSMIB



## China Markers

These must-have grease pencils mark most lens surfaces and will remove easily. Available in five vibrant colors.

**\$2.29**  
each

**\$18.99**  
box of 12

Black 99-CHINABLCK-1  
Blue 99-CHINABLUE-1  
Red 99-CHINARED-1  
White 99-CHINAWHTE-1  
Yellow 99-CHINAYLLW-1

Black 99-CHINABLCK-12  
Blue 99-CHINABLUE-12  
Red 99-CHINARED-12  
White 99-CHINAWHTE-12  
Yellow 99-CHINAYLLW-12



# Axis 221 Lensmeter

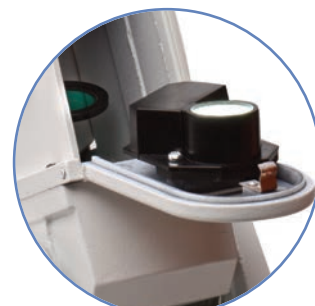

LED Bulb

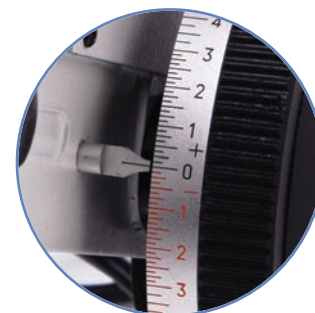

Precision Scale



Prism Compensator

## Outer Reading Lensmeter

This finely crafted lensmeter is handmade to the highest standards. The Axis 221 Lensmeter uses superior quality optics, an LED light source, and includes a prism compensator in its user-friendly design. Large ergonomic knobs are clearly marked for ease of use.

32-AXIS221 \$999.99

Also available with self-inking pins

32-AXIS221-SIP \$1,199.99

### Technical specifications:

Target:	American Cross-line
Vertex Power:	Range: 0D to $\pm 20D$
Step:	0.125D up to $\pm 5D$ 0.25 at $\pm 5D$ to $\pm 20D$
Astigmatism Axis:	0 to 180°, minimum scale value 5°
Prism diopter:	1 diopter intervals in the range of 0D to 20D
Prism base angle:	0 to 180°, minimum scale value 5°
Eyepiece focus:	$\pm 5D$
For lens sizes:	30mm to 90mm in diameter
Overall dimensions:	18" x 6.75" x 9.5"
Weight:	16 pounds
Lighting lamp:	LED 110V 25W equivalent

## All-In-One MultiMeter

UV Meter, Photochromic Demonstrator, and Visible Light Meter

The single unit works as a UV Spectrophotometer, Photochromic Lens Demonstrator, and Visible Light Meter. In just seconds, it will activate Transitions® or any other brand photochromic lenses. It will also measure UV transmittance of any lens and visible light transmittance of colored lenses.

The MultiMeter gives any practice the ability to demonstrate how photochromic lenses will look when exposed to sunlight without having to walk outside.

The MultiMeter's versatility makes it a must-have selling tool for any eyecare professional.



- Digital UV readings
- Activate photochromic lenses in seconds
- Great for matching tint density

Dimensions (W x H x D):  
6.75" x 6.75" x 10"  
Power: 110 Volt

99-MULTIMETER \$499.99



## Pro Series Ultrasonic Cleaner 1,400 mL

This ultrasonic unit is equipped with an industrial grade stack transducer and a solid control panel with sensing technology for better water resistance and reliability.

- Ultrasonic frequency: 42,000Hz
- Tank material: Stainless steel SUS303
- Tank capacity: 1,400 mL (1.48 quarts)
- Quiet, solid state circuitry



Power: 110V / 60W  
Weight: 5 pounds  
Dimensions: (W x H x D)  
9.6" x 6.5" x 9.0"

32-ULTRASNC1400 \$169.99



## Pro Series Ultrasonic Cleaner 800 mL

This ultrasonic cleaner features an elongated tank and two wafer transducers for increased and uniformly distributed cleaning power.

- Ultrasonic frequency: 42,000Hz
- Tank material: Stainless steel SUS303
- Tank capacity: 800 mL (1.7 pints)
- Timer: 5 cycles with digital time display



Power: 110V / 60W  
Weight: 3 pounds  
Dimensions: (W x H x D)  
8.7" x 5.4" x 5.6"

32-ULTRASNC800 \$99.99



## Digital Ultrasonic Cleaner 1,375 mL



**BEST SELLER**

CE

This ultrasonic unit is a combination of the ideal size and power. This digital model includes a removable lid, bright digital display, and timer.

- Ultrasonic frequency: 42,000Hz
- Tank material: Stainless steel SUS303
- Tank capacity: 1,375 mL (1.48 quarts)
- Quiet, solid state circuitry

Power: 110V / 60W  
Weight: 4 pounds  
Dimensions (W x H x D):  
7" x 6.25" x 9"

32-ULTRASNC1375 \$139.99

## Digital Ultrasonic Cleaner 600 mL



CE

This compact unit is the right size for most frames, parts, and tools. The 600mL cleaner features digital controls and timer.

- Ultrasonic frequency: 42,000Hz
- Tank material: Stainless steel SUS303
- Tank capacity: 600mL (1.3 pints)
- Timer: 5 cycles with digital time display

Power: 110V / 35W  
Weight: 2.2 pounds  
Dimensions (W x H x D):  
8.25" x 6" x 5.5"

32-ULTRASNCPINT \$69.99

## Stainless Steel Ultrasonic Cleaner 2,000 mL



CE

This mini-lab sized ultrasonic cleaner is our largest and most powerful machine. The tank will fit any size eyewear. The stainless steel construction and industrial parts will provide years of quality service.

- Ultrasonic frequency: 45,000Hz
- Tank material: Stainless steel SUS303
- Tank capacity: 2,000 mL (2.11 quarts)
- Quiet, solid state circuitry

Power: 110V / 60W  
Weight: 4 pounds  
Dimensions (W x H x D):  
6.25" x 7.75" x 7"

32-ULTRASNC2000 \$199.99

## Ultrasonic Cleaner

Our non-ammonia formula is safe, effective, and fast. Cleans parts, frames, and jewelry. Our Ultrasonic Cleaner does not produce any odors or vapors.

- Concentrated cleaner
- Works with any ultrasonic machine
- Settles particles



Gallon 99-CG \$59.99  
Quart 99-CQ \$19.99

# AR Remover

Quickly remove unwanted or faulty Anti-Reflective coatings with our highly effective formula while patients wait! Save time and improve service.

In just 10 seconds, you can remove most AR coatings and have your patients on their way.

- The all-in-one AR Remover Kit includes an all-plastic lens holder built into the lid, chemical resistant gloves, and protective goggles (compatible with liquid or dry AR remover)
- Dry AR is our concentrated formula which provides the safest way to ship, store, and handle AR remover (mixes with water to make 1 pint)



## AR Remover Kit

Kit	99-ARKO	\$24.99
Kit w/Dry AR	99-ARK	\$74.99

## Liquid AR Remover

8 oz.	99-AR	\$59.99
Quart	99-ARQ	\$199.99

## Dry AR Remover

Each	99-ARC8	\$59.99
3-Pack	99-ARC8-3	\$129.99

## Dispenser Bottle



Convenient and mess-free alternative to dispense lab chemicals.

- One-touch plastic pump
- 4 oz. glass bottle

99-DB4	\$7.99
--------	--------

## Acetone



- Removes ink markings and cleans lenses
- Fast-evaporating
- Quart

99-AQ	\$19.99
-------	---------

## Denatured Alcohol



- Quart
- Use for general cleaning of lenses

99-DAL	\$19.99
--------	---------



## The Original All Off Marking Ink Remover

Remove the Most Stubborn  
Progressive Ink Markings in  
Just 3 Seconds Flat!

Instantly dissolve and remove any progressive ink marking with the industry's most widely used solution. It is safer than acetone and will never ruin polycarbonate lenses. Our award-winning product is used by more labs than any other marking ink remover in the world.

- The industry standard for ink removal
- Acetone-free and safe on polycarbonate lenses
- No scrubbing; eliminates unwanted micro scratches
- Dries instantly; no oily residue

Easily Erase Progressive Ink Markings  
with Our Handy All Off Pen

The unique valve-action mechanism dispenses All Off to the ink-absorbing tip. Simply press down and rub away the most stubborn ink markings in just seconds.

16 oz.	99-AO	\$59.99
4 oz.	99-AO4	\$14.99
Pen	99-AOP	\$19.99

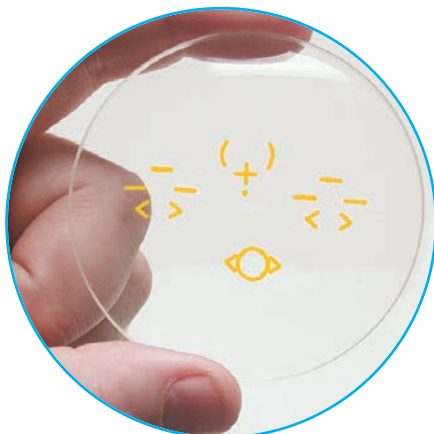

Before



After

## Dispensary Cloth w/Loop

16" x 16" Microfiber Cloth with Sewn Loop

\$4.99 each



White	99-331-0301
Black	99-331-0302
Gray	99-331-0303

## Lab Size Microfiber Cloths

\$3.99 each

- Three Materials Available:  
Terry - a looped knit just like terry cloth towels  
Suede - thick flocked material that is very soft and absorbent  
Microfiber - soft and silky fabric
- Large 12" x 15" size



Terry



Terry Cloth	33-LCLTTLBLU
Suede Cloth	33-LCLTSLBLU
Black Microfiber Cloth	33-LABCLOTHBLK
Gray Microfiber Cloth	33-LABCLOTHGRY

## Isopropyl Alcohol

99% Pure Isopropyl Alcohol



**Buy More, Save More!**

Quart Bulk Pricing

Quantity	Price
1-3:	\$11.99
4-9:	\$ 7.99
10+:	\$ 5.99

Quart	99-IAL	\$11.99
5 Gallons	99-IA5	\$99.99

## Lens Cleaner Refill

Refill customer or dispensary lens cleaner bottles. Choose from one gallon size or 2.5 gallon cubitainer with spigot.

- Available in clear or purple cleaner



Purple Cleaner

99-LCG	Gallon	\$24.99
99-LCD	2.5 Gallon	\$59.99

Clear Cleaner

99-LCGC	Gallon	\$24.99
99-LCDC	2.5 Gallon	\$59.99

# Tools





# Hand-Friendly Ergonomic Pliers

Our Hand-Friendly Ergonomic Pliers are built with your comfort in mind. Cushioned handles are tailored for ease of use while maintaining the professional functionality of each specific plier.

- Non-slip cushion grip
- Smooth-action spring eliminates sticking
- Polished stainless steel construction
- Lifetime guarantee

## Compression Sleeve Assembly Pliers

- Designed for easy assembly of 3-piece mount frames
- Works with all compression sleeves

34-OSTHF452      \$29.99

Replacement Tips  
34-OSTHF452RT      \$2.99



## Compression Sleeve Removal "Push" Pliers

- Easily pushes out broken or damaged compression sleeves
- Nylon jaws protect the lens surface

34-OSTHF454      \$29.99

Replacement Tips  
34-OSTHF454RT      \$2.99



## Compression Sleeve Trimming Pliers

- Trim away long bushings for a precise fit
- Sharp jaws do not crush soft plastic sleeves

34-OSTHF456      \$29.99



## Compression Sleeve Removal “Pull” Pliers

- Designed for easy removal of compression sleeves
- Helps prevent damage to expensive frames and lenses

34-OSTHF453      \$29.99

## 3-Piece Frame Adjusting Pliers

- Contoured jaws cradle temple and compression sleeve
- Easily adjusts fragile drill-mount frames
- Helps prevent damage to expensive lenses

34-OSTHF435      \$29.99

Replacement Tips  
34-OSTHF435RT      \$2.99

## Lens Screw Holding Pliers

- Hold end piece of rimless frame to make adjustments to pantoscopic tilt
- Securely cradle lens screws for precise adjustments

34-OSTHF717      \$29.99

Replacement Tips  
34-OSTHF717RT      \$2.99

## Lens Aligning Pliers

- Use for making precise axis adjustments
- Swivel pads conform to any lens

34-OSTHF432      \$29.99

Replacement Tips  
34-OSTHF432RT      \$2.99



LENS CLEANER

CASES

ACCESSORIES

DISPENSING

OPTOMETRIC

SURFACING

FINISHING

TOOLS

FRAME PARTS



## Hand-Friendly Ergonomic Pliers

### Eyewire Shaping Pliers

- Reshape metal eyewires to conform with lens curvatures
- Double-leaf spring design for convenience and comfort

34-OSTHF434 \$29.99

Replacement Tips

34-OSTHF434RT \$2.99

### Eyewire Bending Pliers

- Reform eyewire or add face curve to a flat frame front
- Adjust bridges and temple tips

34-OSTHF613 \$29.99

Replacement Tips

34-OSTHF613RT \$2.99

### Eyewire Bending Micro Pliers

- Used to bend or straighten eyewires, temples, or nose pad arms
- Pointed three-finger design provides leverage for adjustments in tight spaces

34-OSTHF513 \$29.99

### Screw Flaring Closure Pliers

- Flare the end of screws to prevent backing out
- Longer jaw protects screw head during process

34-OSTHF011 \$29.99





## Lens Sizing Pliers

- Provides excellent control and leverage for controlled eyewire closure
- Angled head reduces hand strain
- Also useful for flaring rivets and peening screws

34-OSTHF429      \$34.99



## Nose Pad Arm Anvil Pliers

- Make precise adjustments to nose pad arms
- Small tips fit easily in tight areas

34-OSTHF863      \$29.99



## Slim Nose Pad Arm Adjusting Pliers

- Designed for adjusting most nose pad arm configurations
- Concave jaw supports nose pad mount

34-OSTHF437      \$29.99



## Crimp-On Nose Pad Crimping Pliers

- Attach crimp-on style nose pads securely
- Precisely folds crimp-on tabs for a secure fit

34-OSTHF235      \$29.99





## Hand-Friendly Ergonomic Pliers

### Nose Pad Removal Pliers

- Pushes nose pad out of its holder
- Use with all snap-style nose pads

34-OSTHF379      \$29.99

### Numont Pliers

- Opposing grooves in jaws secure frames for precision end piece adjustment
- Grooves support semi-rimless frames for finite adjustments

34-OSTHF214      \$29.99

### Bent Post Pliers

- Use to brace and grip hinge barrels
- Jaws parallel at 5mm; jaw width is 3.5mm
- Jaws bend at 45° angle

34-OSTHF008      \$24.99

### Bridge Reducing Pliers

- Jaw system holds bridge from both sides for a precise bridge reduction
- For metal and plastic frames

34-OSTHF129      \$29.99



## Temple Bending Pliers

- For adjustments to both plastic and metal temples
- Strong and smooth nylon jaws
- Double-leaf spring designed for convenience

34-OSTHF433 \$29.99

Replacement Tips  
34-OSTHF433RT \$2.99



## Wide Jaw Angling Pliers

- Use to make pantoscopic and retoscopic angle adjustments
- Wide jaws accommodate even the thickest temples
- Also useful for modifying end pieces

34-OSTHF401 \$29.99



## Inclination Pliers

- Triangular metal jaw cradles hinges for extra support when making delicate adjustments
- 10mm wide jaws

34-OSTHF557 \$29.99

Replacement Tips  
34-OSTHF557RT \$2.99



## Flat/Round Snipe Nose Pliers

- All-purpose adjusting pliers
- Double-leaf spring designed for comfort and convenience

34-OSTHF430 \$29.99





## Hand-Friendly Ergonomic Pliers

### Screw Extraction Pliers

- Remove broken screws with ease
- Double-leaf spring designed for convenience and comfort
- Foam cushioned handles for non-slip gripping

34-OSTHF038      \$29.99

### Round Metal/Flat Nylon Pliers

- Flat nylon jaw prevents marring of frame
- End piece wraps around jaw to easily bring temples in or out
- For use on all metal temples

34-OSTHF412      \$29.99

Replacement Tips

34-OSTHF412RT      \$2.99

### Double Nylon Jaw Pliers

- Holds plastic or metal frames without marring
- 10mm wide jaw

34-OSTHF014      \$29.99

Replacement Tips

34-OSTHF014RT      \$2.99

### Narrow Double Nylon Pliers

- Holds plastic or metal frames without marring
- 8mm wide jaw

34-OSTHF053      \$29.99

Replacement Tips

34-OSTHF053RT      \$2.99



## Nylon Gripping Pliers

- Smooth and tough nylon jaw protects frames
- Double-leaf spring designed for convenience and comfort

34-OSTHF405 \$29.99

Replacement Tips  
34-OSTHF405RT \$2.99



## Flat Chain Nose Pliers

- Provides excellent control and leverage for the best adjustments
- Use to adjust temples, bridges, and pad arms
- Great for any kind of holding or shaping work

34-OSTHF410 \$29.99



## Long Snipe Nose Pliers

- Long tapered-nose pliers for adjustments in tight areas
- Double-leaf spring design for convenience

34-OSTHF428 \$39.99



## Bent Snipe Nose Pliers

- Angled jaws for easy adjustments in tight places
- Polished stainless steel construction

34-OSTHF431 \$29.99





## Hand-Friendly Ergonomic Pliers

### Heavy Duty Side Cutting Pliers

With Tungsten-Carbide Tips

- Easily cut screws or temple-ends for a clean finish
- Available in right-hand and left-hand configurations
- Has an 11mm cutter length and an overall 160mm length

R-Hand 34-OSTHF424 \$39.99  
L-Hand 34-OSTHF425 \$39.99

### Chappel Cutting Pliers

With Tungsten-Carbide Tips

- Chips away excess lens material
- Cuts nickel-silver screws and rivets
- Double-leaf spring designed for convenience

34-OSTHF451 \$39.99

### Heavy-Duty Cutting Pliers

With Tungsten-Carbide Tips

- Extended handles for added strength and cutting power
- Excellent for cutting core wires and heavy nickel-silver screws
- Double-leaf spring designed for convenience and comfort

34-OSTHF039 \$39.99

### 6" Top Cutting Pliers

With Tungsten-Carbide Tips

- Double-action hinges increase applied force
- Cuts stainless steel screws and rivets
- Design allows for flush cuts in tight areas
- Total length of the pliers is 6 inches

34-OSTHF023-6TO \$49.99



## Leverage Screw Cutting Pliers

- Safely cut silver and brass screws on rimless frames
- Not suitable for steel screws

34-OSTHF578      \$29.99



## Large Deblocking Pliers

- Removes blocks quickly and easily without damaging lenses
- 14mm diameter

34-OSTHFDEBL      \$34.99



## Small Deblocking Pliers

- Removes blocks quickly and easily without damaging lenses
- 11mm diameter

34-OSTHFDEBLS      \$34.99



## Angled Deblocking Pliers

- The angled design decreases stress for safer deblocking on AR coated lenses
- Fits all 14mm blocks

34-OSTHFDEBLANG      \$34.99



## Titanium Pliers

Our Titanium tools are another OptiSource exclusive product. Never before have optical pliers been so carefully designed and precision manufactured. The close attention to detail can be seen from the tight tolerances in the jaws down to the milled logo in the handles. All titanium tools are designed with an internal box spring made of pure titanium, stainless steel handles and jaws, and finished with a blue iridescent titanium coating.

- A selection of our ten best-selling pliers
- Buy individually or as a set
- Internal box spring



## Eyewire Shaping Pliers

- Reshape metal eyewires to conform with lens curvatures
- Internal spring design for convenience and comfort

34-OSTTT434      \$49.99

Replacement Tips

34-OSTTT434RT      \$3.99



## Double Nylon Jaw Pliers

- Holds plastic or metal frames without marring
- 10mm wide jaw

34-OSTTT014      \$49.99

Replacement Tips

34-OSTTT014RT      \$3.99





## Side Cutting Pliers

With Tungsten-Carbide Tips

- Easily cut screws for temple-ends for a clean finish
- Has an 11mm cutter length and an overall 160mm length

34-OSTTT424 \$54.99

## Lens Aligning Pliers

- Use for making precise axis adjustments
- Swivel pads conform to any lens

34-OSTTT432 \$54.99

Replacement Tips

34-OSTTT432RT \$3.99

## Compression Sleeve Assembly Pliers

- Designed for easy assembly of 3-piece mount frames
- Works with all compression sleeves

34-OSTTT452 \$49.99

Replacement Tips

34-OSTTT452RT \$3.99

## Angled Deblocking Pliers

- The angled design decreases stress for safer deblocking on AR coated lenses
- Fits all 14mm blocks

34-OSTTTDEBLANG \$49.99

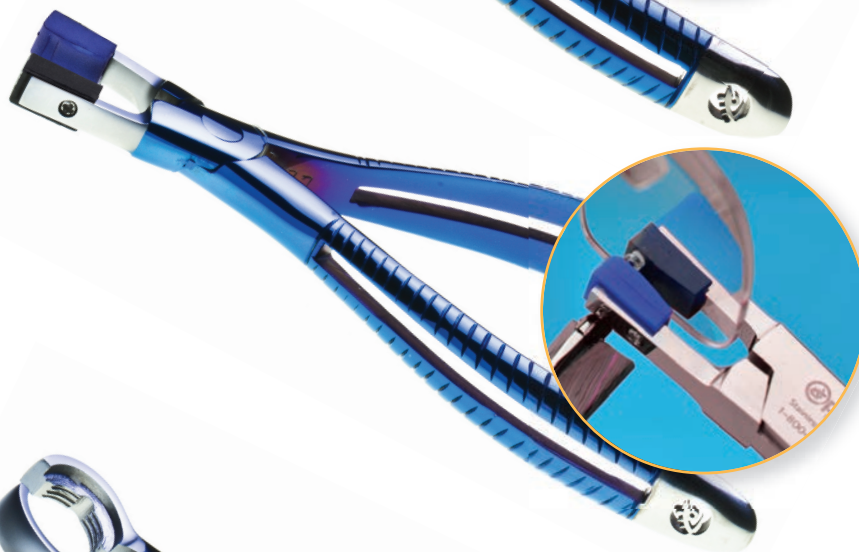
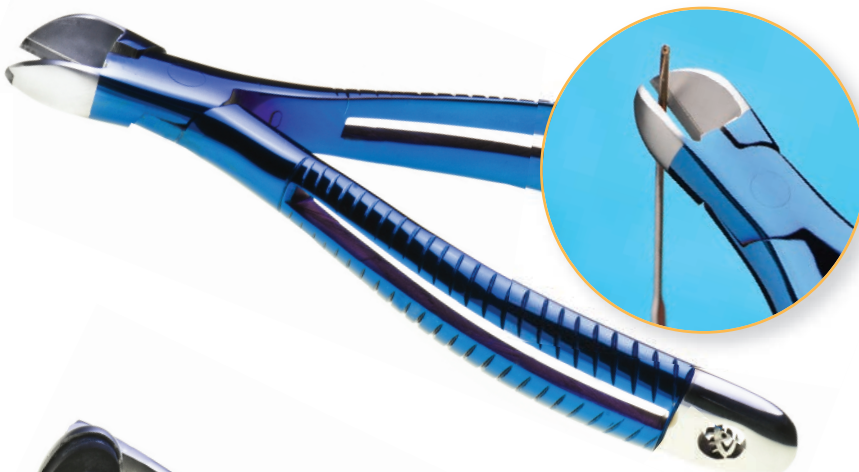

## TOOLS

### Titanium Pliers

### Slim Nose Pad Arm Adjusting Pliers

- Designed for adjusting most nose pad arm configurations
- Concave jaw supports nose pad mount

34-OSTTT437 \$49.99

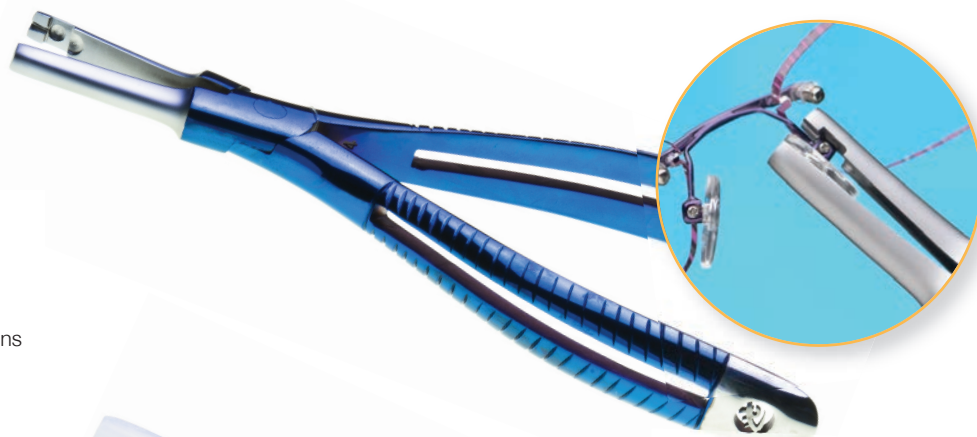

### Nylon Gripping Pliers

- Smooth and tough nylon jaw protects frames
- Internal spring design for convenience and comfort

34-OSTTT405 \$49.99

Replacement Tips  
34-OSTTT405RT \$3.99

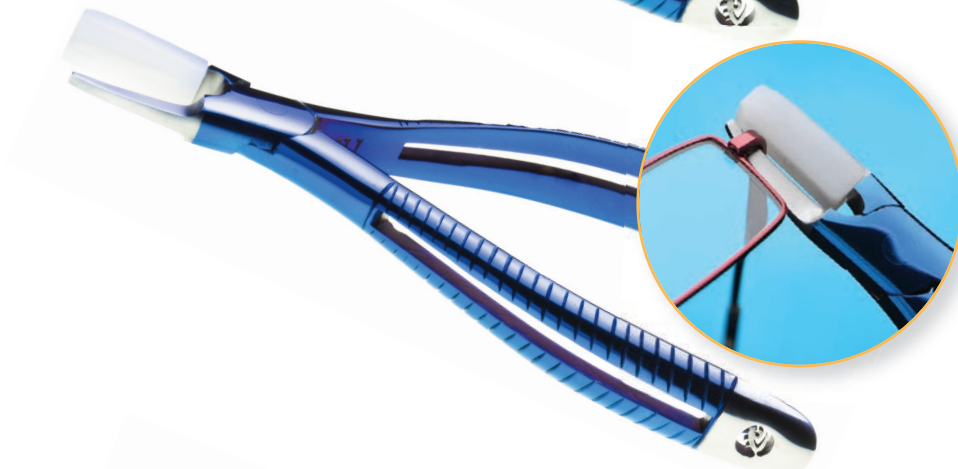

### Long Snipe Nose Pliers

- Long tapered-nose pliers for adjustments in tight areas
- Internal spring design for convenience and comfort

34-OSTTT428 \$49.99



### Round Metal/Flat Nylon Pliers

- Flat nylon jaw prevents marring of frame
- End piece wraps around jaw to easily bring temples in or out
- For use on full metal and semi-rimless frames

34-OSTTT412 \$49.99

Replacement Tips  
34-OSTTT412RT \$3.99



## Lady's Pliers

Our Lady's pliers are designed specifically to fit smaller hands. The comfortable rubberized grip is emblazoned with the pink Breast Cancer Awareness Ribbon.

A portion of the proceeds from the sale of our Lady's Tools will be donated to the Breast Cancer Research Foundation ([www.bcrfcure.org](http://www.bcrfcure.org)).



- A selection of our ten best-selling pliers
- Buy individually or as a set
- Sales benefit Breast Cancer Research Foundation

## Nylon Gripping Pliers

- Smooth and tough nylon jaw protects frames
- Internal spring design for convenience and comfort

34-OSTLL405      \$29.99

Replacement Tips  
34-OSTLL405RT      \$3.99



## Compression Sleeve Assembly Pliers

- Designed for easy assembly of 3-piece mount frames
- Works with all compression sleeves

34-OSTLL452      \$29.99

Replacement Tips  
34-OSTLL452RT      \$3.99



## TOOLS

### Lady's Pliers

#### Slim Nose Pad Arm Adjusting Pliers

- Designed for adjusting most nose pad configurations
- Concave jaw supports nose pad mount

34-OSTLL437      \$29.99

#### Double Nylon Jaw Pliers

- Holds plastic or metal frames without marring
- 10mm wide jaw

34-OSTLL014      \$29.99

Replacement Tips

34-OSTLL014RT      \$3.99

#### Eyewire Shaping Pliers

- Reshape metal eyewires to conform with lens curvatures
- Internal spring design for convenience and comfort

34-OSTLL434      \$29.99

Replacement Tips

34-OSTLL434RT      \$3.99

#### Lens Aligning Pliers

- Use for making precise axis adjustments
- Swivel pads conform to any lens

34-OSTLL432      \$29.99

Replacement Tips

34-OSTLL432RT      \$3.99



## Round Metal/Flat Nylon Pliers

- Flat nylon jaw prevents marring of frame
- End piece wraps around jaw to easily bring temples in or out
- For use on full metal and semi-rimless frames

34-OSTLL412 \$29.99

Replacement Tips  
34-OSTLL412RT \$3.99



## Deblocking Pliers

- The angled design decreases stress for safer deblocking on AR coated lenses
- Fits all 14mm blocks

34-OSTLLDEBLANG \$34.99



## Side Cutting Pliers

With Tungsten-Carbide Tips

- Easily cut screws for temple-ends for a clean finish
- Has an 11mm cutter length and an overall 160mm length

34-OSTLL424 \$39.99



## Long Snipe Nose Pliers

- Long tapered-nose pliers for adjustments in tight areas
- Internal spring design for convenience and comfort

34-OSTLL428 \$39.99



## Pro Line Pliers

- A selection of our twenty most popular pliers
- Lightweight handles
- Slim, non-slip grips

Our Pro Line pliers feature a super-slim design perfectly made to fit smaller hands. The non-slip vinyl grips and lightweight handles reduce fatigue and provide superior comfort and control.



## Compression Sleeve Assembly Pliers

- Designed for easy assembly of 3-piece mount frames
- Works with all compression sleeves

34-OSTPL452 \$26.99

Replacement Tips  
34-OSTHF452RT \$2.99

## 3-Piece Frame Adjusting Pliers

- Contoured jaws cradle temple and compression sleeve
- Easily adjusts fragile drill-mount frames
- Helps prevent damage to expensive lenses

34-OSTPL435 \$26.99

Replacement Tips  
34-OSTPL435RT \$2.99

## Lens Aligning Pliers

- Use for making precise axis adjustments
- Swivel pads conform to any lens

34-OSTPL432 \$26.99

Replacement Tips  
34-OSTPL432RT \$2.99

## Eyewire Shaping Pliers

- Reshape metal eyewires to conform with lens curvatures
- Internal spring design for convenience and comfort

34-OSTPL434 \$26.99

Replacement Tips  
34-OSTPL434RT \$2.99

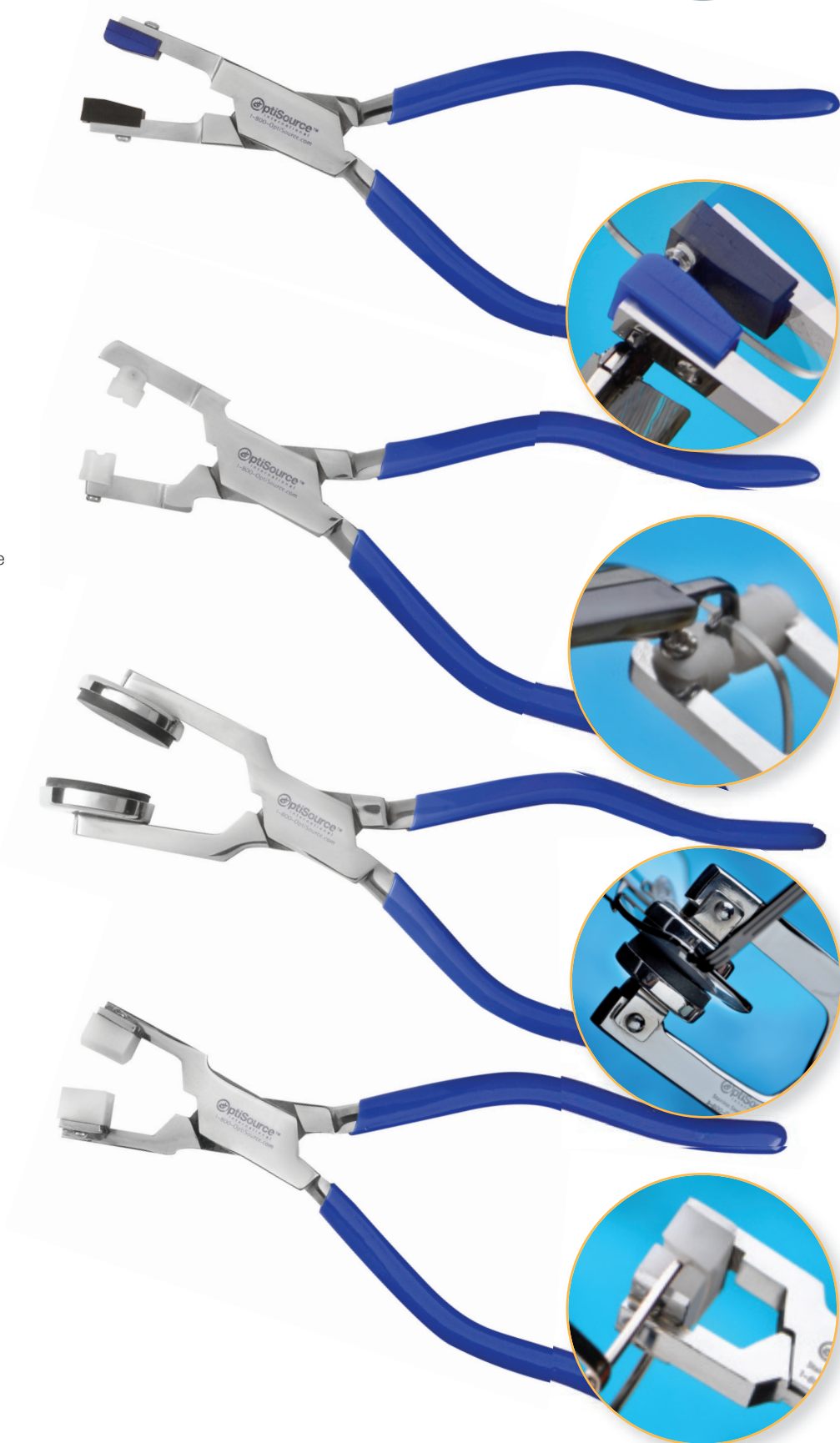

## Slim Nose Pad Arm Adjusting Pliers

- Designed for adjusting most nose pad arm configurations
- Concave jaw supports nose pad mount

34-OSTPL437      \$26.99



## Crimp-On Nose Pad Crimping Pliers

- Attach crimp-on style nose pads securely
- Precisely folds crimp-on tabs for a secure fit

34-OSTPL235      \$26.99



## Nose Pad Removal Pliers

- Pushes nose pad out of its holder
- Use with all snap-style nose pads

34-OSTPL379      \$26.99



## Temple Bending Pliers

- For adjustments to both plastic and metal temples
- Strong and smooth nylon jaws
- Internal spring design for convenience and comfort

34-OSTPL433      \$26.99

Replacement Tips  
34-OSTPL433RT      \$2.99



LENS CLEANER

CASES

ACCESSORIES

DISPENSING

OPTOMETRIC

SURFACING

FINISHING

TOOLS

FRAME PARTS

## TOOLS

### Pro Line Pliers

#### Round Metal/Flat Nylon Pliers

- Flat nylon jaw prevents marring of frame
- End piece wraps around jaw to easily bring temples in or out
- For use on all metal temples

34-OSTPL412 \$26.99

Replacement Tips

34-OSTHF412RT \$2.99



#### Wide Jaw Angling Pliers

- Use to make pantoscopic and retroscopic angle adjustments
- Wide jaws accommodate even the thickest temples
- Also useful for modifying end pieces

34-OSTPL401 \$26.99

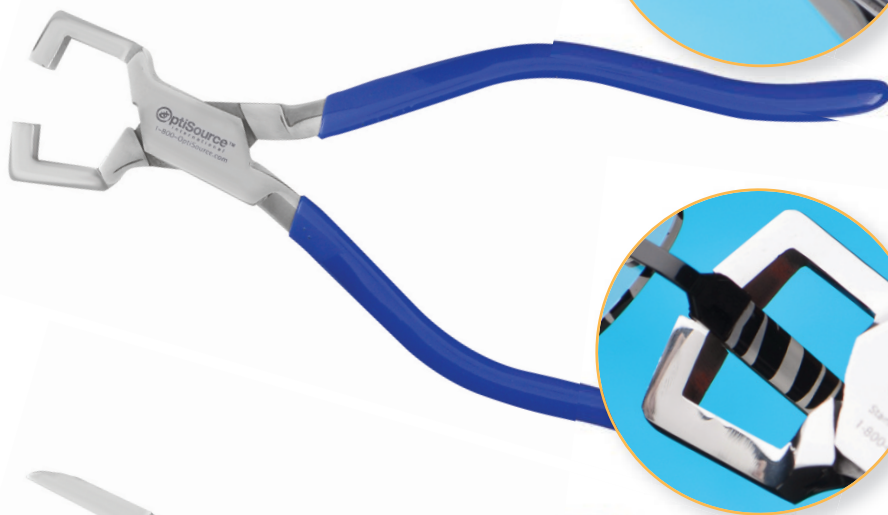

#### Screw Extraction Pliers

- Remove broken screws with ease
- Internal spring design for convenience and comfort

34-OSTPL038 \$26.99



#### Flat/Round Snipe Nose Pliers

- All-purpose adjusting pliers
- Internal spring design for convenience and comfort

34-OSTPL430 \$26.99





## Double Nylon Jaw Pliers

- Holds plastic or metal frames without marring
- 10mm wide jaw

34-OSTPL014      \$26.99

Replacement Tips  
34-OSTHF014RT      \$2.99



## Narrow Double Nylon Pliers

- Holds plastic or metal frames without marring
- 8mm wide jaw

34-OSTPL053      \$26.99

Replacement Tips  
34-OSTPL053RT      \$2.99



## Nylon Gripping Pliers

- Smooth and tough nylon jaw protects frames
- Internal spring design for convenience and comfort

34-OSTPL405      \$26.99

Replacement Tips  
34-OSTPL405RT      \$2.99



## Flat Chain Nose Pliers

- Provides excellent control and leverage for the best adjustments
- Use to adjust temples, bridges, and pad arms
- Great for any kind of holding or shaping work

34-OSTPL410      \$26.99



LENS CLEANER

CASES

ACCESSORIES

DISPENSING

OPTOMETRIC

SURFACING

FINISHING

TOOLS

FRAME PARTS

## Pro Line Pliers

### Bent Snipe Nose Pliers

- Angled jaws for easy adjustments in tight places
- Polished stainless steel construction

34-OSTPL431      \$26.99



### Heavy Duty Side Cutting Pliers

With Tungsten-Carbide Tips

- Easily cut screws or temple-ends for a clean finish
- Available in right-hand and left-hand configurations

R-Hand 34-OSTPL424      \$35.99

L-Hand 34-OSTPL425      \$35.99



### Heavy-Duty Cutting Pliers

With Tungsten-Carbide Tips

- Extended handles for added strength and cutting power
- Excellent for cutting core wires and heavy nickel-silver screws
- Internal spring design for convenience and comfort

34-OSTPL039      \$35.99



## Multi-Tool Holder with Drawers



Tools Not Included

- 2 drawers in the front hold frame parts
- Holds 6 screwdrivers and up to 8 pliers

78-TB07 \$59.99

## Tool Case

- Neatly and securely holds 10 pliers
- Heavy duty zipper
- Durable leatherette material



34-TOOLCASE \$29.99

## Handle Sleeves

Are the Hand Grips on Your Pliers Getting Old and Worn Out?

Instead of replacing your pliers, just change the handle sleeves. These durable cushioned handle sleeves provide excellent comfort and extend the life of your tools.



34-OSTBLKFOAM \$5.99

## Tool Holders

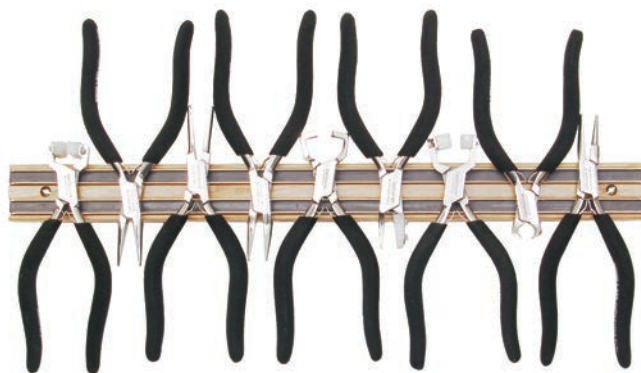

24" Magnetic Wall Bar Tool Holder

Tools Not Included

34-HOLDMAGNET \$29.99



Tools Not Included

9" Metal Table-Top Tool Holder

34-HOLDMETAL \$11.99



Tools Not Included

Curved Plastic Tool Rack

- Bench block work surface
- 5 parts drawers
- Holds 6 screwdrivers and 8 pliers

78-TB08 \$54.99

## Tool Kits



### 10-Piece Titanium Tool Kit

This set of ten Titanium pliers is a selection of our best selling tools. The travel case is a luxurious and durable storage solution.

- Slim Pad Arm Adjusting Pliers
- Eyewire Shaping Pliers
- Lens Aligning Pliers
- Nylon Gripping Pliers
- Flat/Round Metal Pliers
- Side Cutter Pliers (right)
- Long Snipe Nose Pliers
- Angled Deblocking Pliers
- Double Jaw Nylon Pliers
- Compression Sleeve Assembly Pliers

34-OSTTT-SET10 \$499.99



### 10-Piece Lady's Tool Kit

This set of ten Lady's pliers is a selection of our best selling tools. The travel case is a luxurious and durable storage solution. Sales benefit Breast Cancer Research Foundation.

- Slim Pad Arm Adjusting Pliers
- Eyewire Shaping Pliers
- Lens Aligning Pliers
- Nylon Gripping Pliers
- Flat/Round Metal Pliers
- Side Cutter Pliers (right)
- Long Snipe Nose Pliers
- Angled Deblocking Pliers
- Double Jaw Nylon Pliers
- Compression Sleeve Assembly Pliers

34-OSTKLL \$299.99

## Tool Kits



### 8-Piece Hand-Friendly Tool Kit

This 8-piece hand-friendly tool set is designed with your comfort in mind. Cushioned handles are tailored for ease of use while maintaining the professional functionality of each specific tool.

- Wide Jaw Angling Pliers
- Nylon Gripping Pliers
- Lens Axis Aligning Pliers
- Chain Nose Pliers
- Flat/Round Metal Pliers
- Bionic Thumb Temple Bender
- Pad Arm Adjusting Pliers
- Narrow Double Nylon Pliers

34-OSTKHF      \$229.99

### 11-Piece Rimless Hand-Friendly Tool Kit

This 11-piece hand-friendly tool set is designed with your comfort in mind. Contains eleven rimless hand-friendly tools critical for assembly and adjusting of rimless work. Entire set fits in a tailored leatherette case for easy storage and carrying.

- Wide Jaw Angling Pliers
- Flat/Round Pliers
- Pad Arm Adjusting Pliers
- Narrow Double Nylon Pliers
- 3-Piece Rimless Pliers
- Compression Frame Removal Pliers
- Compressing Pliers
- Compression Sleeve Trimming Pliers
- Compressing Sleeve Punch Pliers
- Hole Beveling Tool
- Scribe

34-OSTKRIMLESS      \$254.99

## TOOLS

### Aluminum Handle Reversible Screwdrivers

\$7.99 each



- Shaft constructed of aluminum
- Reversible blades easily snap in and out
- Includes one reversible blade

Phillips-Head	1.6mm/2.0mm	34-SLSDPHIL
Flat-Head	1.6mm/2.2mm	34-SLSDFLAT

### Brass Handle Reversible Screwdrivers

\$15.99 each

Solid Brass Shaft with Anti-Roll Top

- Thick, textured handle
- Super-smooth spinning
- Reversible blades
- Anti-roll top removes for storage of extra blades



Phillips-Head	1.6mm/2.0mm	34-SL105A
Flat-Head	1.6mm/2.2mm	34-SL113

### Replacement Blades

\$7.99 per pack

- Fits aluminum and brass screwdrivers on this page
- New and improved hardened steel

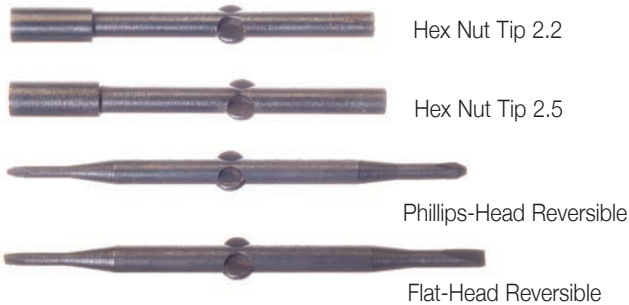

Hex Nut Tip 2.2mm	1 Blade	34-HEXRP2.2
Hex Nut Tip 2.5mm	1 Blade	34-HEXRP2.5
Phillips-Head 1.6mm/2.0mm	4 Blades	34-PHILLIPS
Flat-Head 1.6mm/2.2mm	4 Blades	34-FLATHEAD

### Ball Bearing Screwdrivers

\$19.99 each

These stainless steel screwdrivers offer substantial grip and tactile smoothness with their ball bearing head design. The screwdriver top is removable for storage of additional blades.

- 1.6mm/2.2mm flat-head blade included
- Available in large and medium sizes



Hex Handle 34-SLDSBBL



Round Handle 34-SLDSBBM

### Plastic Hex Nut Wrenches

\$9.99 each



2.2mm hex wrench



2.5mm hex wrench

2.2mm	34-SL312
2.5mm	34-SL311

## 9-Piece Deluxe Screwdriver Set w/Swivel Base

Phillips-Head, Flat-Head, Hex, and Star Screwdrivers

**\$64.99**

- 2 Flat-heads: 1.6, 1.8
- 2 Phillips-heads: 1.5, 1.8
- 3 Hex tips: 2.02, 2.32, 2.57
- 2 Star tips: 2.52, 2.82
- Heavy weight swivel base

9-Piece Screwdriver Set

78-TA19B

### Replacement Tips (3 Pack)

Flat - 1.6mm	78-TA19B-011RT
Flat - 1.8mm	78-TA19B-021RT
Phillips - 1.5mm	78-TA19B-031RT
Phillips - 1.8mm	78-TA19B-041RT
Hex - 2.02mm	78-TA19B-051RT
Hex - 2.32mm	78-TA19B-061RT
Hex - 2.57mm	78-TA19B-071RT
Star - 2.52mm	78-TA19B-081RT
Star - 2.82mm	78-TA19B-091RT

**\$5.99**  
3 Pack

### Replacement Driver Handle w/Tips

Flat - 1.6mm	78-TA19B-011
Flat - 1.8mm	78-TA19B-021
Phillips - 1.5mm	78-TA19B-031
Phillips - 1.8mm	78-TA19B-041
Hex - 2.02mm	78-TA19B-051
Hex - 2.57mm	78-TA19B-061
Hex - 2.57mm	78-TA19B-071
Star - 2.52mm	78-TA19B-081
Star - 2.82mm	78-TA19B-091

**\$6.99**  
each



## Screw Gripper

- Hold and lock screws and nuts in position while removing or placing



78-TA20D

\$24.99

## Screwdriver w/Gripper

- Hold and lock screws in position while screwing
- Screwdriver is a 1.8 flathead



78-TA20C

\$15.99

## Optical Tweezer



34-OST030 \$7.99

## Insulated Curved Self-Closing Tweezer



34-OST031 \$7.99

## Insulated Self-Closing Tweezer



34-OST032 \$7.99

## Self-Closing Optical Tweezer

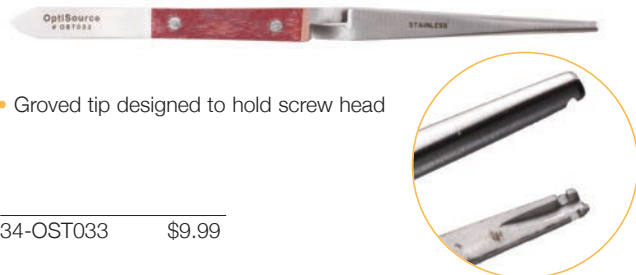

- Grooved tip designed to hold screw head

34-OST033 \$9.99

## Pad Removing Tweezer



34-OST034 \$7.99

## Nylon-Brass Mallet



- Dual-headed, all-purpose mallet
- Brass head for firm strikes
- Nylon head for delicate, non-marking strikes

34-OST108 \$11.99

## Riveting Hammer

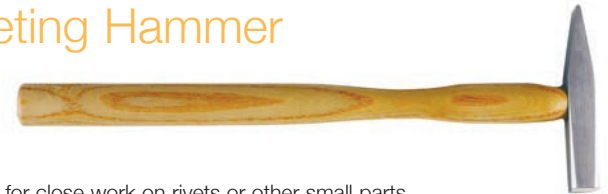

- Use for close work on rivets or other small parts
- Balanced design for precision work

34-OST109 \$11.99

## All-Purpose Lab Snips



- Excellent for hand-cutting plastic pattern blanks
- All-purpose snips feature comfort handles

34-OST299 \$6.99

## Soldering Clamps

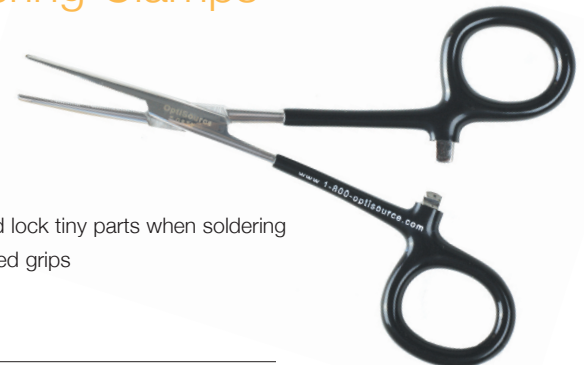

- Hold and lock tiny parts when soldering
- Cushioned grips

Straight	34-OST040	\$7.99
Curved	34-OST041	\$7.99



# Screw Extractor Kit

- Made from zinc alloy and copper
- Easily remove broken or stripped screws
- Rethread stripped barrels



Anvil



Bit in Drill

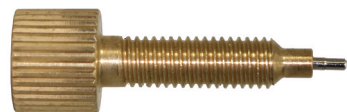

Needle



Bit



Tap

Screws Extractor	78-T004	\$59.99
------------------	---------	---------

### Replacement Parts

1.0 bit	78-T004B-1.0	\$3.99
1.2 bit	78-T004B-1.2	\$3.99
1.2 tap	78-T004C-1.2	\$3.99
1.4 tap	78-T004C-1.4	\$3.99
1.6 tap	78-T004C-1.6	\$3.99
1.0 cap	78-T004D-1.0	\$9.99
1.2 cap	78-T004D-1.2	\$9.99
0.9 needle	78-T004E-.9	\$14.99
1.1 needle	78-T004E-1.1	\$14.99
Replacement anvil	78-T004F	\$9.99

## 10-Piece Mini-File Set

- Compact organizer case
- Variety of file shapes and finishes



78-TA64 \$24.99

## Files

### Files and Handles



#### Bent Flat Needle File

68-LI-252 \$12.99

#### Half-Round File

68-LI-151 \$7.99



#### Round File

68-LI-152 \$7.99



#### Plate File

68-LI-150 \$7.99

#### 4" Wood Handles

03-37.836 5/8" Insert \$2.00

03-37.833 3/8" Insert \$2.00



### Wood Handle Files



#### Flat

68-LI-110 \$11.99



#### Half-Round

68-LI-113 \$14.99



#### Flat Double Cut

68-LI-130 \$27.99



#### Half-Round

68-LI-165 \$29.99



#### Screw Head Finishing

68-LI-250/50 \$42.99



# Rimless

## 9-Piece Rimless Driver-Bit Set

\$64.99 each

Everything you would ever need to complete or repair quality rimless work.

- Case organizes all tips and driver handle
- Includes 9 attachments for use with driver handle or most drill machines

78-TA04B



Included bits (from left to right):

- 1.0mm Drill Bit
- 1.2mm Drill Bit
- 1.4mm Drill Bit
- 1.5mm Drill Bit
- Flat Blade
- Phillips Blade
- Screw Finisher
- Lens Back-side Countersink Bit
- Lens Front-Side Countersink Bit

### Replacement Drill Bits

\$7.00 each

1.0mm	78-TA04B-1.0
1.2mm	78-TA04B-1.2
1.4mm	78-TA04B-1.4
1.5mm	78-TA04B-1.5

## Tabco Smart Drill Bits

\$7.99 each

0.80mm	54-T1320.080
0.90mm	54-T1320.090
1.00mm	54-T1320.100
1.10mm	54-T1320.110
1.15mm	54-T1320.115
1.20mm	54-T1320.120
1.25mm	54-T1320.125
1.30mm	54-T1320.130
1.32mm	54-T1320.132
1.35mm	54-T1320.135
1.40mm	54-T1320.140
1.45mm	54-T1320.145
1.50mm	54-T1320.150
1.60mm	54-T1320.160
1.70mm	54-T1320.170
1.80mm	54-T1320.180
1.90mm	54-T1320.190
2.00mm	54-T1320.200
2.10mm	54-T1320.210
2.20mm	54-T1320.220
2.25mm	54-T1320.225

## Rimless Scribe Tool

- Clean and size drilled rimless holes



34-280 \$19.99

## Nylon Line Hook

- Assists in the application of interliner

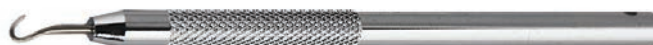

78-TA48 \$7.99

## Rimless Hole Beveling Tool

- Deburs drilled rimless holes



Replacement Tip

34-438 \$17.99

Replacement Tip  
34-438RT \$5.99

## Screw Finisher Tool

- Rounds jagged edges of cut screws



34-318 \$14.99

## Compression Sleeve Removal Tool



34-056 \$9.99

## Clavulus Hand Press

The Clavulus Hand Press is a staple tool for the consummate optical professional. It is constructed of stainless steel for the highest quality and smooth operation.

- Perform dozens of repairs and adjustments on this precision tool
- Made of stainless steel for years of continuous performance
- Heavy weight aluminum base



Includes:

- Peening punch
- Riveting punch
- Flaring punch
- Rivet puller
- Punch for Spread Hinges
- Single punch
- Double punch
- Anvils

Dimensions (w x h x d):  
135 x 290 x 175mm



34-HANDPRESS \$219.99

Replacement parts available online at [www.1-800-OptiSource.com](http://www.1-800-OptiSource.com)

## Helping Hands

Need a third hand for those difficult repair jobs? Our Helping Hands repair station is designed to hold the frame securely while you perform delicate repairs.

- Weighted base prevents slipping
- Adjustable alligator clips grip down firmly
- Hinged bar allows for easy positioning



99-HELPINGHANDS \$14.99

## Hockey Puck Bench Block

The name says it all. The OptiSource Hockey Puck is the perfect anti-slip work surface for hinge and other repairs. Includes double-sided tape to stick to the bench top.



99-BENCHPUCK \$14.99

## 3x ZELCO FLX Tabletop Lumifier with 5x bifocal



This high quality, optical grade, 3x magnifying lens with a 4" diameter is ideal for both optical professionals during frame assembly, repair, or adjustment as well as for patients for reading, sewing, arts, and crafts. The base is weighted for stability and armored in rubber for protection. The soft touch switch illuminates the three super bright, cool white LED bulbs. Requires 4 "AA" batteries.

35-570285 \$52.92

# Bionic Thumb

“The world’s best frame bending tool”

Original Bionic Thumb, the World's Best Frame Bending Tool. This will become your “most used tool” and you will find new uses for it the more you put it to work. The perfect tool for bending temples, eyewires, and endpieces. Use the large radius over your thumb or index finger for heavy duty bending power and control. Use the smaller radius for tighter bends on thinner, more flexible frames.

- Made from 1/8" thick by 5/8" wide stainless steel
- Durable suede bending surfaces
- Perfect for bending temples, eyewires, and endpieces
- Prevent screwdriver accidents



Old Way



Bionic Way



99-342-01

\$24.99

## Anvil Bench Block

Our bench top anvil is the perfect repair companion. It saves your countertop from gouges and scratches and provides round contour for leverage and shaping.



34-ANVIL

\$38.99

## Table Edge Bench Block

This angled metal block with durable rubber pad easily mounts to most table edges to provide a smooth, flat, hard work surface for repairs.

95-301

\$9.99



# TOOLS

Innovative Tools by



## The Temple Tamer

Straighten and Bend Ear Pieces Comfortably

Be kind to your fingers when adjusting an ear piece or changing temple tips. Stop burning your fingers when adjusting the curve of an ear piece by letting The Temple Tamer take the heat and do the work.



15-W2084-2      \$29.00

Bend an ear piece

Straighten an ear piece

## The Stealth Driver



4-5/8" long

- The head swivels and pivots to always fit securely in the palm of your hand
- Ergonomic design eliminates wrist and elbow fatigue
- Reversible flat-head blade included

15-W2050      \$26.00

## Rimlon Harpoon

For easily removing/inserting the rimlon cord out from/into the lens groove



15-W2089      \$9.00

## PJ Pliers

PJs Feature Long, Comfortable Foam Covered Grips and Narrow Jaws

## PJ Eyewire Screw Inserting Pliers

- Easily insert and tighten the eyewire screw while holding the eyewire closed
- New parallel jaw design holds the eyewire closed more securely
- Reduces damage to lenses or frames by keeping the screwdriver tip from slipping off the eyewire screw head



15-W5106F      \$42.00

## PJ Double Delrin Jaw Pliers

- The 8mm wide exclusive dovetail Delrin pad protects the frame surface
- Use it to adjust the angle of the end piece without marring the frame
- The round metal jaw tapers to a fine point to fit into tight spaces

15-W5115F \$44.00

## PJ Temple Angling Pliers

- Use to grip plastic or metal frames when bending temples or altering the eyewire.
- Superior Delrin pads are only 8mm wide, allowing you to get into restricted spaces
- The pads are dovetailed so replacing them is quick and easy

15-W5112F \$42.00

## PJ Pantoscopic Tilt Pliers

- Securely grip the hinge, end piece, or temple edges on a metal frame to modify the temple angle for proper pantoscopic tilt
- A recessed hole in each jaw protects the hinge screw when working with the barrel
- Grooves in the jaw prevent slipping when grabbing the temple directly

15-W5145F \$40.00

## PJ Post Pushing Pliers

- Easily and safely extract the bushing from a rimless lens
- Due to parallel jaw design, little effort is required to delicately push out the post and tubing from the holes
- Pins pivot easily to accommodate horizontal and vertical mounting systems

15-W5121F \$44.50

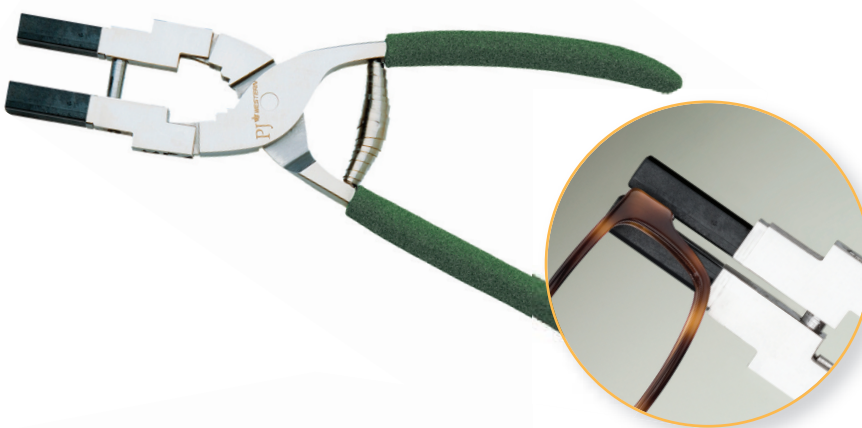

## Rimless Alignment Measuring Tool

Our Rimless Assembly Measuring Tool is a precision instrument that allows you to check the accuracy of your drilled rimless work. The cross-grids are etched with numbered scales to measure both horizontally and vertically from different reference points on the frame.

- Checks rimless accuracy
- Precision milled aluminum
- Numbered scales and rule

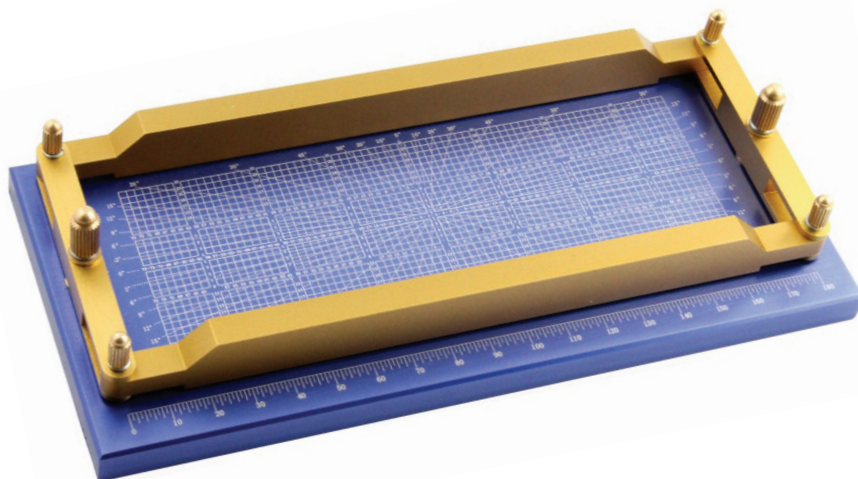

78-T012B \$69.99

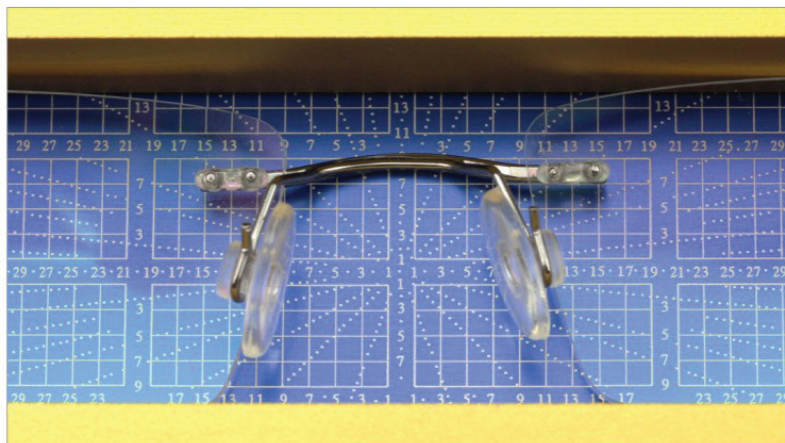
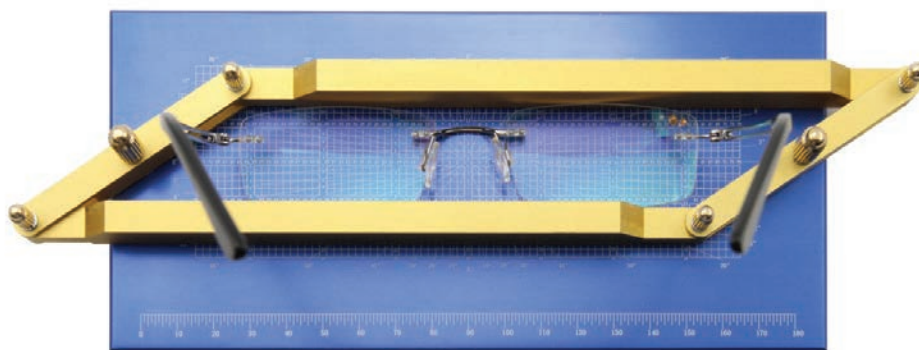

## Lens Alignment Gauge

The precision grids on this non-marring acrylic gauge allow for checking of lens alignment in mounted eyewear.

- Made from non-marring acrylic
- Check lens alignment accuracy
- Grids are marked for measuring A, DBL, and seg-height

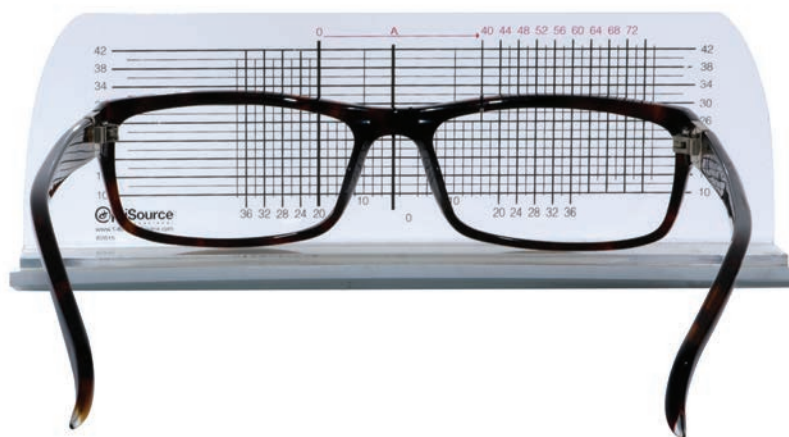

99-809-1 \$24.99



## Digital Caliper

- Precisely measures screws, holes, parts, and more
- Range: 0 -100mm, 0 - 4"



78-TA43 \$59.99

## Calipers

- Precisely measures lens thickness up to 19mm
- Graduated in 0.20mm increments
- Stainless steel with brass index plate



Lens Thickness Caliper	34-OST001CAL	\$29.99
Wide Jaw Caliper	34-OST110	\$29.99

## Lens Hole Gauge

- Easily measure lens holes
- Measure 20 different hole sizes

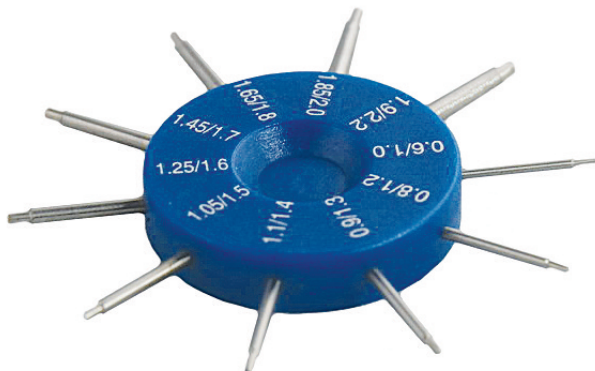

78-TA16B \$18.99

## Multi-Use Lens Clock

- Determines the base curve of plastic lenses
- Precision instrument
- Measures both 1.49 and 1.60 index



32-LENSCLOCK \$59.99

## 1.53 Index Lens Clock

- Determines base curve measurements and 1.53 index lenses
- Useful for reference index measurements



32-LENSCLOCK153 \$59.99

LENS CLEANER

CASES

ACCESSORIES

DISPENSING

OPTOMETRIC

SURFACING

FINISHING

TOOLS

FRAME PARTS

## PD Rulers

Our PD rulers are multifunctional, indispensable tools. Not only do they accurately measure pupillary distance with three different printed scales, but they will also help during dispensing with a notched hinge-measuring edge and screw thickness gauge (both printed on the rear of the ruler). They are comfortable, lightweight, and medium thickness.

- Choose from two different styles

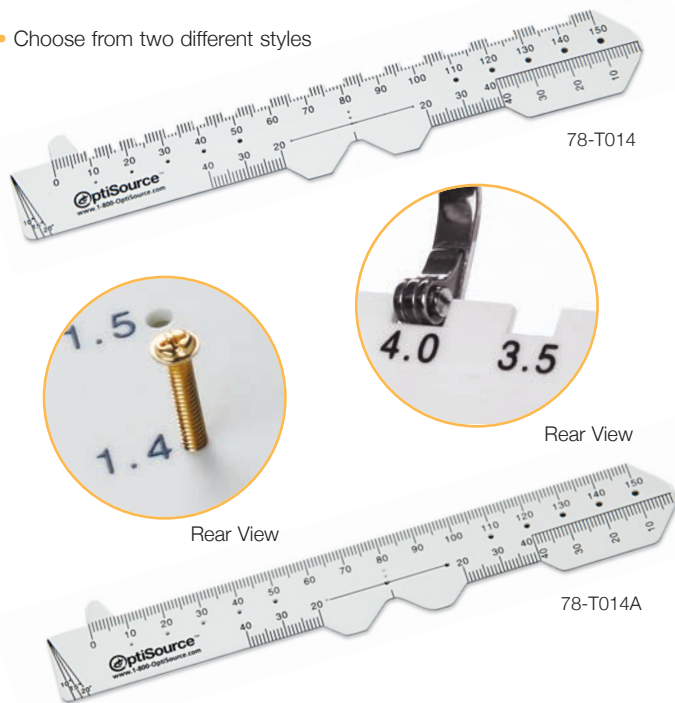

Multi-Function PD Ruler	78-T014	\$1.69
Straight Edge PD Ruler	78-T014A	\$1.69

## Wood and Plastic PD Ruler



- Real wood design with high-contrast polymer-backed metric scale
- Millimeters on the front and inches on the back

99-PDWOOD	\$6.99
-----------	--------

## Metal PD Ruler



- Stainless steel
- 90mm scales for left or right-handed measurements
- 40mm scale for multifocal and pupil heights

99-359-01	\$2.99
-----------	--------

## Distometer

Take the Fuss Out of Vertex Measurements with our Distometer

- Incorrect vertex distance will change the effective power of a prescription
- Avoid costly remakes and troubleshooting time by measuring vertex accurately
- With each distometer, you will receive a conversion scale for easy calculations



99-391-1	\$114.99
----------	----------

## PAL Fitting Tool

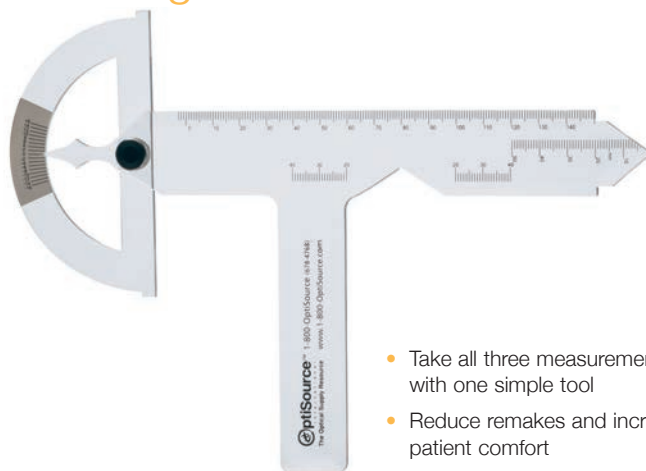

- Take all three measurements with one simple tool
- Reduce remakes and increase patient comfort

Our PAL Fitting Tool is designed to easily measure your patient's PD, Pantoscopic Tilt, and Vertex Distance. This tool will help ensure that your patient's lenses will be properly aligned with their position-of-wear.

78-PALFITTOOL	\$22.99
---------------	---------

# Frame Parts





Needle tip for easy insertion



**Snapit**  
frame screws

## Screw it in, Snap it off

Breaks Cleaner, Smoother, and Flatter

OptiSource International is the exclusive manufacturer of Snapit® patented frame screws. These high quality stainless steel screws have a unique, extra long feeder tip that makes handling screws a cinch and repairs a pleasure.

After the screw is inserted into any hinge or eyewire, the long feeder tip simply snaps off cleanly with just your fingers leaving a smooth finish. Clipping and filing is eliminated. All Snapit® screws will self-align, self-tap stripped threads, and include the OptiSource Stay-Tight™ thread lock.

- Eyewires, Hinges, Spring Hinges
- Self Aligns, Self Taps
- Includes Stay-Tight™ thread lock
- Available in Silver, Gold, Gunmetal, and Black
- Protected by US and International Patents\*

**\*PATENT NUMBERS:**

USA – 8070403, 8375546, 8556556, 8997327  
 Australia – 2008283850, 2011101044  
 China – 2L2008 80102133.2  
 Philippines – 1/2010/500274  
 South Africa – 2010/03664  
 Russia – 2493446



Align



Screw

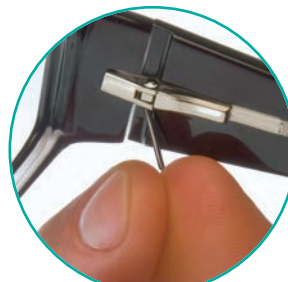

Snap

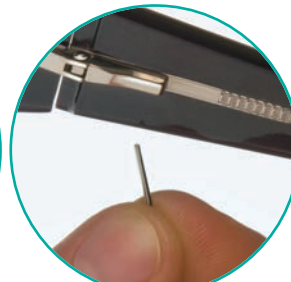

Remove



### Snapit® Wheel

Includes 250 assorted Snapit® screws. Available in silver or gold.

Silver	02-SILVERWHEEL	\$109.99
Gold	02-GOLDWHEEL	\$119.75



### Snapit® Vial Holder

Holds 16 Snapit® vials and 5 screwdrivers (Vials and screwdrivers sold separately)

02-DISPLAY	\$29.99
------------	---------



### Snapit® Eyeglass Repair Kit

Kit includes 5 Snapit® screws and a screwdriver in a convenient storage tube.

- Display holds 12 repair kits
- Sold in cases of 24

02-REPAIRKIT	Each	\$1.99
--------------	------	--------

# Selecting and Ordering Flat-Head Snapit® Screws

1. Select Eyewire or Hinge size from table below
2. Select color code



3. Select quantity

\* Available in select sizes

	SILVER	GOLD	GUNMETAL	BLACK
Vials - 50 Screws	\$19.75	\$21.75	\$21.75	\$21.75
Bulk - 200 Screws	\$67.75	\$73.75	\$73.75	\$73.75

## How to Order

1. Select code from the size guide below
  2. Add color code  
Examples for Eyewire 1.2 x 4.0 x 1.8 (50 screws)  
**Silver:** 02-124018      **Gunmetal:** 02-124018GM  
**Gold:** 02-124018G      **Black:** 02-124018B
- NOTE: To order Bulk (200 screws) add "B" after 02-  
Example: Bulk Gold Hinge 1.3 x 3.5 x 2.0 (200 screws)  
Gold: 02-B133520G

	Thread x Length x Head	Code	Also Available in Gunmetal & Black
Eyewire	1.2 x 4.0 x 1.8	02-124018	✓
	1.2 x 4.8 x 1.8	02-124818	
	1.3 x 3.0 x 1.8	02-133018	
	1.3 x 4.0 x 1.8	02-134018	✓
	1.3 x 4.8 x 1.8	02-134818	
	1.4 x 3.0 x 1.8	02-143018	✓
	1.4 x 4.0 x 1.8	02-144018	✓
	1.4 x 4.8 x 1.8	02-144818	
	1.5 x 3.0 x 1.8	02-153018	
	1.5 x 4.0 x 1.8	02-154018	✓
Hinge	1.5 x 4.8 x 1.8	02-154818	
	1.3 x 3.5 x 2.0	02-133520	✓
	1.4 x 3.5 x 2.0	02-143520	✓
	1.4 x 4.0 x 2.0	02-144020	✓
	1.4 x 4.0 x 2.5	02-144025	
	1.4 x 4.8 x 2.0	02-144820	✓
	1.4 x 4.8 x 2.5	02-144825	
	1.4 x 5.5 x 2.0	02-145520	
	1.4 x 5.5 x 2.5	02-145525	
	1.5 x 3.5 x 2.0	02-153520	
	1.5 x 4.0 x 2.0	02-154020	✓
	1.5 x 4.0 x 2.5	02-154025	
	1.5 x 4.8 x 2.0	02-154820	
	1.5 x 4.8 x 2.5	02-154825	
	1.5 x 5.5 x 2.0	02-155520	
1.5 x 5.5 x 2.5	02-155525		

## Phillips-Head Size Guide

50 Screws Per Vial

### Silver \$22.75

	Thread x Length x Head	Code
Eyewire	1.2 x 4.0 x 1.8	02-124018-P
	1.3 x 4.0 x 1.8	02-134018-P
	1.4 x 3.0 x 1.8	02-143018-P
	1.4 x 4.0 x 1.8	02-144018-P
	1.5 x 4.0 x 1.8	02-154018-P

	Thread x Length x Head	Code
Hinge	1.3 x 3.5 x 2.0	02-133520-P
	1.4 x 3.5 x 2.0	02-143520-P
	1.4 x 4.0 x 2.0	02-144020-P
	1.4 x 4.8 x 2.0	02-144820-P
	1.5 x 4.0 x 2.0	02-154020-P

### Gold \$24.75

	Thread x Length x Head	Code
Eyewire	1.3 x 4.0 x 1.8	02-134018G-P
	1.4 x 4.0 x 1.8	02-144018G-P

	Thread x Length x Head	Code
Hinge	1.4 x 3.5 x 2.0	02-143520G-P
	1.4 x 4.0 x 2.0	02-144020G-P
	1.5 x 4.0 x 2.0	02-154020G-P

### Gunmetal \$24.75

	Thread x Length x Head	Code
Eyewire	1.3 x 4.0 x 1.8	02-134018GM-P
	1.4 x 4.0 x 1.8	02-144018GM-P

	Thread x Length x Head	Code
Hinge	1.4 x 3.5 x 2.0	02-143520GM-P
	1.4 x 4.0 x 2.0	02-144020GM-P
	1.5 x 4.0 x 2.0	02-154020GM-P

### Black \$24.75

	Thread x Length x Head	Code
Eyewire	1.3 x 4.0 x 1.8	02-134018BK-P
	1.4 x 4.0 x 1.8	02-144018BK-P

	Thread x Length x Head	Code
Hinge	1.4 x 3.5 x 2.0	02-143520BK-P
	1.4 x 4.0 x 2.0	02-144020BK-P
	1.5 x 4.0 x 2.0	02-154020BK-P

# Precision Stainless Screws

OptiSource offers a huge variety of the most popular and hard-to-find screws. Our screws are precision manufactured to the tightest tolerances and come in color-coded vials with easy-to-read descriptions. Our exclusive Stay-Tight™ thread lock coating keeps screws in place to eliminate back-out or loosening. (Screws with Stay-Tight™ include “ST” in the part number.)



## Rimless Screws

**BUY MORE, SAVE MORE!**

Mix & Match 5 or More Vials From Pages 220-223 and Pay Bulk Price

Color/Head	Description	Thread Dia.	Length	Head Dia.	Qty.	Code	Price	Bulk Price
⊠	Decorative Square Hex Trim Screw	1.4	11.0	2.0	50	44-25-14110	\$19.99	\$15.99
★	Star Head Trim Screw	1.2	11.0	2.3	50	44-23-12110	\$12.99	\$10.39
★	Star Head Trim Screw	1.4	11.0	2.3	50	44-23-14110	\$12.99	\$10.39
⊗	Rosette Lens Screw	1.7	9.0	2.8	50	44-03-1031	\$19.99	\$15.99
⊗	Rosette Lens Screw	1.7	9.0	2.8	50	44-03-1031-02	\$20.99	\$16.79
⊖	Lens Screw	1.2	9.4	1.9	50	44-05-111	\$9.99	\$7.99
⊖	Lens Screw	1.2	9.4	1.9	50	44-05-111-02	\$10.99	\$8.79
⊕	Lens Screw	1.2	10.0	2.5	50	33-R122510S01	\$9.99	\$7.99
⊕	Lens Screw	1.2	10.0	2.5	50	33-R122510G01	\$10.99	\$8.79
⊕	Lens Screw	1.4	10.0	2.5	50	33-R142510S02	\$9.99	\$7.99
⊕	Lens Screw	1.4	10.0	2.5	50	44-25-405-02-P	\$10.99	\$8.79
⊖	Lens Screw	1.2	10.0	2.5	50	33-R122510S03	\$11.99	\$9.59
⊖	Lens Screw	1.2	10.0	2.5	50	33-R122510G03	\$12.99	\$10.39
⊖	Lens Screw	1.4	10.0	2.5	50	33-R142510S03	\$11.99	\$9.59
⊖	Lens Screw	1.4	10.0	2.5	50	33-R142510G03	\$12.99	\$10.39
⊖	Hex Lens Screw	1.4	10.6	2.2	50	44-22-106-14	\$11.99	\$9.59
⊖	Hex Lens Screw	1.4	10.6	2.2	50	44-22-106-14-02	\$12.99	\$10.39
⊖	Lens Screw	1.4	10.5	2.5	50	44-25-405	\$9.99	\$7.99
⊖	Lens Screw	1.4	10.5	2.5	50	44-25-405-02	\$10.99	\$8.79
⊖	Lens Screw	1.16	20.0	2.5	50	44-05-179	\$10.99	\$8.79
⊖	Lens Screw	1.16	20.0	2.5	50	44-05-179-02	\$11.99	\$9.59
⊖	Lens Screw	1.27	8.8	2.5	50	44-05-190	\$10.99	\$8.79
⊕	Lens Screw	1.2	9.4	1.9	50	44-05-111-PM	\$9.99	\$7.99
⊕	Lens Screw	1.4	0.0	2.5	50	44-25-405-PM	\$9.99	\$7.99

## Rimless Top Hat Bushing



Inner Dia./Depth	Outer Dia.	Qty.	Code	Price	Bulk Price
1.20 x 2.8	2.5	50	33-P1228	\$ 8.99	\$7.19
1.40 x 2.8	2.5	50	33-P1428	\$ 8.99	\$7.19
1.32 x 1.3	2.5	100	44-80-132	\$13.99	\$11.19
1.40 x 2.0	2.8	100	44-80-140	\$13.99	\$11.19

## Rimless Caps



1.20	2.5	50	33-RC2512	\$5.99	\$4.79
1.40	2.5	50	33-RC2514	\$5.99	\$4.79

## Rimless Omni-Nut Assembly



Inner Dia.	Outer Dia.	Qty.	Code	Price	Bulk Price
1.20	2.5	50	33-OM077514	\$15.99	\$12.79
1.40	2.5	50	33-OM077614	\$15.99	\$12.79

## Reach Nuts



Silver

1.22	1.5 (5mm long)	50	44-25-161	\$22.99	\$18.39
1.40	1.8 (5mm long)	50	44-25-163	\$22.99	\$18.39



Gold

1.22	1.5 (5mm long)	50	44-25-161-02	\$23.99	\$19.19
1.40	1.8 (5mm long)	50	44-25-163-02	\$23.99	\$19.19



## Rimless Washers

Inner Dia.	Outer Dia.	Qty.	Code	Price	Bulk Price
Transparent Plastic 					
1.3	2.6	50	44-25-1326	\$6.99	<b>\$5.59</b>
1.4	2.8	50	44-25-1405	\$6.99	<b>\$5.59</b>
1.6	2.5	50	44-25-308	\$6.99	<b>\$5.59</b>
1.4	2.8	250	44-25-1405-250	\$23.99	<b>\$19.19</b>
Silver Metal 					
1.3	2.6	50	33-MN1326S	\$7.99	<b>\$6.39</b>
1.4	2.8	50	33-MN1428S	\$7.99	<b>\$6.39</b>
1.5	2.8	50	33-MN1528S	\$7.99	<b>\$6.39</b>
1.4	2.5	100	44-25-133	\$17.99	<b>\$14.39</b>
Gold Metal 					
1.3	2.6	50	33-MN1326G	\$8.99	<b>\$7.19</b>
1.4	2.8	50	33-MN1428G	\$8.99	<b>\$7.19</b>
1.5	2.8	50	33-MN1528G	\$8.99	<b>\$7.19</b>



## Rimless Hex Nuts

Silver  					
1.16	2.5	100	44-05-116	\$13.99	<b>\$11.19</b>
1.2	2.2	100	44-05-101	\$13.99	<b>\$11.19</b>
1.4	2.5	50	44-25-421	\$8.99	<b>\$7.19</b>
Gold					
1.16	2.5	100	44-05-116-2	\$14.99	<b>\$11.99</b>
1.2	2.2	100	44-05-101-02	\$14.99	<b>\$11.99</b>
1.4	2.5	50	44-25-421-02	\$9.99	<b>\$7.99</b>

## Rimless Star Nuts

Silver  					
1.2	2.55	50	44-25-206	\$7.99	<b>\$6.39</b>
1.4	2.50	50	44-25-208	\$7.99	<b>\$6.39</b>
Gold					
1.2	2.55	50	44-25-206-02	\$7.99	<b>\$6.39</b>
1.4	2.50	50	44-20-1425G	\$7.99	<b>\$6.39</b>

## Rimless Dome Nuts

Silver  					
1.3	2.5	100	44-25-135	\$16.99	<b>\$13.59</b>
1.4	2.5	100	44-1.4CAP	\$16.99	<b>\$13.59</b>
1.4	2.5	25	44-1.4CAP-25	\$6.99	<b>\$5.59</b>
1.2	2.2	50	33-DN1222S	\$11.99	<b>\$9.59</b>
1.2	2.2	25	33-DN1222S-25	\$6.99	<b>\$5.59</b>
1.4	2.2	50	33-DN1422S	\$11.99	<b>\$9.59</b>
Gold					
1.3	2.5	100	44-25-135-02	\$18.99	<b>\$15.19</b>
1.4	2.5	100	44-1.4CAP-02	\$18.99	<b>\$15.19</b>
1.4	2.5	25	44-1.4CAP-02-25	\$6.99	<b>\$5.59</b>
1.2	2.2	50	33-DN1222G	\$11.99	<b>\$9.59</b>

## Compression Mounting Sleeves

### Hard Double Post



Outer Dia. x Length	Qty.	Code	Price	Bulk Price
1.4 x 2.2	50	44-SC1-1422	\$14.99	<b>\$11.99</b>
1.4 x 4.0	50	44-SC1-1440	\$14.99	<b>\$11.99</b>
1.4 x 7.0	50	44-SC1-1470	\$14.99	<b>\$11.99</b>
1.4 x 7.0	100	44-SC1-1470-100	\$27.99	<b>\$22.39</b>
1.4 x 7.0	200	44-SC1-1470-200	\$53.99	<b>\$43.19</b>
1.5 x 2.2	50	44-SC1-1522	\$14.99	<b>\$11.99</b>
1.5 x 4.0	50	44-SC1-1540	\$14.99	<b>\$11.99</b>
1.5 x 7.0	50	44-SC1-1570	\$14.99	<b>\$11.99</b>
1.5 x 7.0	200	44-SC1-1570-200	\$53.99	<b>\$43.19</b>
1.8 x 7.0	50	44-SC1-1870	\$14.99	<b>\$11.99</b>

### Medium Double Post



1.4 x 7.0	50	33-SH1450	\$14.99	<b>\$11.99</b>
1.4 x 7.0	100	33-SH1450-100	\$27.99	<b>\$22.39</b>
1.4 x 7.0	200	33-SH1450-200	\$53.99	<b>\$43.19</b>
1.5 x 7.0	50	33-SH1550	\$14.99	<b>\$11.99</b>
1.6 x 7.0	50	33-SH1650	\$14.99	<b>\$11.99</b>

### Soft Double Post



1.4 x 7.0	50	44-SS1-1470	\$14.99	<b>\$11.99</b>
1.4 x 7.0	100	44-SS1-1470-100	\$27.99	<b>\$22.39</b>
1.4 x 7.0	200	44-SS1-1470-200	\$53.99	<b>\$43.19</b>
1.5 x 7.0	50	44-SS1-1570	\$14.99	<b>\$11.99</b>
1.5 x 7.0	100	44-SS1-1570-100	\$27.99	<b>\$22.39</b>
1.5 x 7.0	200	44-SS1-1570-200	\$53.99	<b>\$43.19</b>
1.6 x 7.0	50	44-SS1-1670	\$14.99	<b>\$11.99</b>
1.6 x 7.0	100	44-SS1-1670-100	\$27.99	<b>\$22.39</b>
1.6 x 7.0	200	44-SS1-1670-200	\$53.99	<b>\$43.19</b>

### Hard Single Post



1.4 x 2.2	50	44-SC2-1422	\$14.99	<b>\$11.99</b>
1.4 x 4.0	50	44-SC2-1440	\$14.99	<b>\$11.99</b>
1.4 x 7.0	50	44-SC2-1470	\$14.99	<b>\$11.99</b>
1.5 x 2.2	50	44-SC2-1522	\$14.99	<b>\$11.99</b>
1.5 x 4.0	50	44-SC2-1540	\$14.99	<b>\$11.99</b>
1.5 x 7.0	50	44-SC2-1570	\$14.99	<b>\$11.99</b>

### Airlock Bushings

2.2 x 7.5	50	44-SC2-13522	\$14.99	<b>\$11.99</b>
-----------	----	--------------	---------	----------------

# FRAME PARTS

**BUY MORE, SAVE MORE!**  
 Mix & Match Vials From Pages 220-223  
 and Pay Bulk Price

## Vial Cap & StayTight Color Reference

Color	Thread
Orange	1.0mm
Blue	1.4mm
Red	1.1mm
Green	1.5mm
Grey	1.2mm
Black	1.6mm
Yellow	1.3mm
Light Orange	1.7mm



**All Screws  
 in this section include  
 Stay-Tight™  
 for FREE!**

## Self-Aligning Spring Hinge Screws

Color	Thread x Length x Head	Qty.	Code	Price	Bulk Price
Grey	1.2 x 3.0 x 2.0	100	44-7SAM1.2ST	\$20.99	<b>\$16.79</b>
Yellow	1.2 x 3.0 x 2.0	100	44-7SAM1.2-02ST	\$22.99	<b>\$18.39</b>
Grey	1.3 x 3.0 x 2.0	100	44-7SAM1.3ST	\$20.99	<b>\$16.79</b>
Yellow	1.3 x 3.0 x 2.0	100	44-7SAM1.3-02ST	\$22.99	<b>\$18.39</b>
Grey	1.4 x 3.0 x 2.0	100	44-80-030ST	\$20.99	<b>\$16.79</b>
Yellow	1.4 x 3.0 x 2.0	100	44-80-030-02ST	\$22.99	<b>\$18.39</b>
Grey	1.4 x 3.5 x 2.0	100	44-80-035ST	\$20.99	<b>\$16.79</b>
Yellow	1.4 x 3.5 x 2.0	100	44-80-035-02ST	\$22.99	<b>\$18.39</b>
Grey	1.4 x 4.0 x 2.0	100	44-25-105ST	\$20.99	<b>\$16.79</b>
Yellow	1.4 x 4.0 x 2.0	100	44-25-105-02ST	\$22.99	<b>\$18.39</b>
Grey	1.4 x 4.8 x 2.0	100	44-80.048ST	\$20.99	<b>\$16.79</b>
Yellow	1.4 x 4.8 x 2.0	100	44-80.048-02ST	\$22.99	<b>\$18.39</b>
Grey	1.4 x 6.4 x 2.0	50	44-27-205ST	\$20.99	<b>\$16.79</b>
Grey	1.4 x 9.6 x 2.5	50	44-27-423ST	\$20.99	<b>\$16.79</b>

## Self-Tapping Eyewire Screws

Grey	1.2 x 9.0 x 1.8	50	44-26-601ST	\$15.99	<b>\$12.79</b>
Grey	1.2 x 9.0 x 1.8	25	44-26-601ST-25	\$7.99	<b>\$6.39</b>
Grey	1.2 x 9.0 x 1.8	250	44-26-601ST-250	\$72.99	<b>\$58.39</b>
Yellow	1.2 x 9.0 x 1.8	50	44-26-601-02ST	\$16.99	<b>\$13.59</b>
Grey	1.3 x 9.0 x 1.8	50	44-26-602ST	\$15.99	<b>\$12.79</b>
Grey	1.3 x 9.0 x 1.8	25	44-26-602ST-25	\$7.99	<b>\$6.39</b>
Grey	1.3 x 9.0 x 1.8	125	44-26-602ST-125	\$37.99	<b>\$30.39</b>
Grey	1.3 x 9.0 x 1.8	250	44-26-602ST-250	\$72.99	<b>\$58.39</b>
Yellow	1.3 x 9.0 x 1.8	50	44-26-602-02ST	\$16.99	<b>\$13.59</b>
Grey	1.3 x 9.6 x 1.8	50	44-24-202	\$15.99	<b>\$12.79</b>
Grey	1.4 x 9.0 x 1.8	50	44-26-603ST	\$15.99	<b>\$12.79</b>
Grey	1.4 x 9.0 x 1.8	25	44-26-603ST-25	\$7.99	<b>\$6.39</b>
Grey	1.4 x 9.0 x 1.8	125	44-26-603ST-125	\$37.99	<b>\$30.39</b>
Grey	1.4 x 9.0 x 1.8	250	44-26-603ST-250	\$72.99	<b>\$58.39</b>
Yellow	1.4 x 9.0 x 1.8	50	44-26-603-02ST	\$16.99	<b>\$13.59</b>
Yellow	1.4 x 9.0 x 1.8	25	44-26-603-02ST-25	\$7.99	<b>\$6.39</b>
Yellow	1.4 x 9.0 x 1.8	125	44-26-603-02ST-125	\$37.99	<b>\$30.39</b>
Yellow	1.4 x 9.0 x 1.8	250	44-26-603-02ST-250	\$72.99	<b>\$58.39</b>
Grey	1.5 x 9.0 x 1.8	50	44-26-604ST	\$15.99	<b>\$12.79</b>
Grey	1.5 x 9.0 x 1.8	25	44-26-604ST-25	\$7.99	<b>\$6.39</b>
Yellow	1.5 x 9.0 x 1.8	50	44-26-604-02ST	\$16.99	<b>\$13.59</b>

## Self-Tapping Hinge Screws

Color	Thread x Length x Head	Qty.	Code	Price	Bulk Price
Grey	1.3 x 9.0 x 2.5	50	44-26-605ST	\$17.99	<b>\$14.39</b>
Grey	1.3 x 9.0 x 2.5	25	44-26-605ST-25	\$8.99	<b>\$7.19</b>
Yellow	1.3 x 9.0 x 2.5	50	44-26-605-02ST	\$18.99	<b>\$15.19</b>
Grey	1.4 x 9.0 x 2.5	50	44-26-606ST	\$17.99	<b>\$14.39</b>
Grey	1.4 x 9.0 x 2.5	25	44-26-606ST-25	\$9.99	<b>\$7.99</b>
Yellow	1.4 x 9.0 x 2.5	50	44-26-606-02ST	\$18.99	<b>\$15.19</b>
Grey	1.5 x 9.0 x 2.5	50	44-26-607ST	\$17.99	<b>\$14.39</b>
Yellow	1.5 x 9.0 x 2.5	50	44-26-607-02ST	\$18.99	<b>\$15.19</b>
Grey	1.6 x 9.0 x 2.5	50	44-26-608ST	\$17.99	<b>\$14.39</b>
Yellow	1.6 x 9.0 x 2.5	50	44-26-608-02ST	\$18.99	<b>\$15.19</b>

## Hinge Screws

Grey	1.4 x 2.9 x 2.8	100	44-25-086ST	\$14.99	<b>\$11.99</b>
Yellow	1.4 x 2.9 x 2.8	100	44-25-086-02ST	\$16.99	<b>\$13.59</b>
Grey	1.4 x 3.5 x 2.5	100	44-25-051ST	\$14.99	<b>\$11.99</b>
Yellow	1.4 x 3.5 x 2.5	100	44-25-051-02ST	\$16.99	<b>\$13.59</b>
Grey	1.4 x 3.6 x 2.0	100	44-25-103ST	\$14.99	<b>\$11.99</b>
Yellow	1.4 x 3.6 x 2.0	100	44-25-103-02ST	\$16.99	<b>\$13.59</b>
Grey	1.4 x 4.0 x 2.0	100	44-25-078ST	\$14.99	<b>\$11.99</b>
Yellow	1.4 x 4.0 x 2.0	100	44-25-078-02ST	\$16.99	<b>\$13.59</b>
Grey	1.6 x 4.4 x 2.8	100	44-25-108ST	\$14.99	<b>\$11.99</b>
Yellow	1.6 x 4.4 x 2.8	100	44-25-108-02ST	\$16.99	<b>\$13.59</b>
Grey	1.5 x 3.6 x 2.5	50	44-25-091ST	\$7.99	<b>\$6.39</b>
Grey	1.5 x 4.9 x 2.8	50	44-25-095ST	\$7.99	<b>\$6.39</b>
Grey	1.27 x 4.7 x 2.5	50	44-05-100	\$3.49	<b>\$2.79</b>
Grey	1.27 x 5.5 x 2.0	50	44-05-105	\$3.49	<b>\$2.79</b>
Grey	1.37 x 5.2 x 2.0	50	44-05-153	\$3.49	<b>\$2.79</b>
Grey	1.4 x 3.55 x 2.5	50	44-25-102ST	\$7.99	<b>\$6.39</b>
Grey	1.4 x 4.0 x 2.5	50	44-25-052ST	\$7.99	<b>\$6.39</b>
Yellow	1.4 x 4.0 x 2.5	50	44-25-052-02ST	\$8.99	<b>\$7.19</b>
Grey	1.4 x 4.5 x 2.5	50	44-25-053ST	\$7.99	<b>\$6.39</b>
Grey	1.4 x 5.0 x 2.5	50	44-25-054ST	\$7.99	<b>\$6.39</b>
Grey	1.6 x 4.0 x 2.5	50	44-25-090ST	\$7.99	<b>\$6.39</b>
Grey	1.6 x 5.0 x 2.5	50	44-25-106ST	\$7.99	<b>\$6.39</b>
Grey	1.6 x 3.8 x 3.0	50	44-25-109ST	\$7.99	<b>\$6.39</b>
Grey	1.6 x 5.75 x 3.0	50	44-25-409ST	\$7.99	<b>\$6.39</b>
Grey	1.7 x 5.9 x 2.8	50	44-25-075ST	\$7.99	<b>\$6.39</b>



## Sleeved Hinge

- Unique plastic sleeve compresses when screwed into hinge
- Provides smooth movement and prevents backing out



Color	Thread x Length x Head	Qty.	Code	List Price	Bulk Price
⊖	1.4 x 2.8 x 1.8	50	44-26-304	\$14.99	<b>\$11.99</b>
⊖	1.4 x 3.5 x 1.8	50	44-26-305	\$14.99	<b>\$11.99</b>
⊖	1.4 x 4.0 x 1.8	50	44-26-306	\$14.99	<b>\$11.99</b>
⊖	1.4 x 3.6 x 2.0	50	44-26-309	\$14.99	<b>\$11.99</b>
⊖	1.4 x 4.0 x 2.0	50	44-26-320	\$14.99	<b>\$11.99</b>
⊖	1.4 x 4.6 x 2.0	50	44-26-321	\$14.99	<b>\$11.99</b>

## Stainless Steel Eyewire



⊖	1.2 x 4.4 x 1.5	100	44-25-099ST	\$13.99	<b>\$11.19</b>
⊖	1.2 x 4.4 x 1.5	100	44-25-099-02ST	\$15.99	<b>\$12.79</b>
⊖	1.4 x 5.2 x 1.8	100	44-25-084ST	\$13.99	<b>\$11.19</b>
⊖	1.4 x 5.2 x 1.8	100	44-25-084-02ST	\$15.99	<b>\$12.79</b>
⊖	1.4 x 3.8 x 1.8	100	44-25-100ST	\$13.99	<b>\$11.19</b>
⊖	1.4 x 3.8 x 1.8	100	44-25-100-02ST	\$15.99	<b>\$12.79</b>
+	1.4 x 3.8 x 1.8	50	44-25-100ST-PM	\$7.99	<b>\$6.39</b>
⊖	1.4 x 4.5 x 1.8	100	44-25-101ST	\$13.99	<b>\$11.19</b>
⊖	1.4 x 4.5 x 1.8	100	44-25-101-02ST	\$15.99	<b>\$12.79</b>
⊖	1.3 x 5.2 x 2.0	50	44-25-401ST	\$7.99	<b>\$6.39</b>
⊖	1.6 x 3.5 x 2.0	50	44-25-021ST	\$7.99	<b>\$6.39</b>
⊖	1.6 x 3.5 x 2.0	50	44-25-021-02ST	\$8.99	<b>\$7.19</b>
⊖	1.6 x 4.0 x 2.0	50	44-25-022ST	\$7.99	<b>\$6.39</b>
⊖	1.6 x 4.0 x 2.0	50	44-25-022-02ST	\$8.99	<b>\$7.19</b>
⊖	1.6 x 4.5 x 2.5	50	44-25-023ST	\$7.99	<b>\$6.39</b>
⊖	1.6 x 5.0 x 2.0	50	44-25-024ST	\$7.99	<b>\$6.39</b>

## Nose Pad Screws

Stay-Tight



⊖	1.2 x 3.2 x 1.6	100	44-25-406ST	\$13.99	<b>\$11.19</b>
⊖	1.2 x 3.2 x 1.6	100	44-25-406-02ST	\$15.99	<b>\$12.79</b>

Standard

⊖	1.0 x 4.2 x 1.4	100	44-25-402	\$13.99	<b>\$11.19</b>
⊖	1.0 x 4.2 x 1.4	100	44-25-402-02	\$15.99	<b>\$12.79</b>
+	1.0 x 4.2 x 1.4	50	44-25-402-PM	\$7.99	<b>\$6.39</b>
⊖	1.1 x 5.5 x 1.7	100	44-25-115	\$13.99	<b>\$11.19</b>
⊖	1.1 x 5.5 x 1.7	100	44-25-115-02	\$15.99	<b>\$12.79</b>

Self-Aligning

⊖	1.1 x 5.5 x 1.7	100	44-27-415	\$13.99	<b>\$11.19</b>
⊖	1.1 x 5.5 x 1.7	100	44-27-415-02	\$15.99	<b>\$12.79</b>

## Rimless Wheel

- Contains 500 of the most useful rimless frame parts
- 50 each of 10 different parts
- Screws, nuts, washers, and compression sleeves



44-RIMLESSWHEEL \$99.99

## Best Sellers Wheel

- Contains 250 of our best-selling standard screws
- 25 each of 10 different screws
- Contains both silver and gold screws
- Self-tapping, spring-hinge, and eyewire screws



44-BESTWHEEL \$49.99

## Loctite®

### Loctite® Primerless Threadlocker 243™

- Blue threadlock, gap filler
- 50mL

99-683-243 \$17.99

### Loctite® 4851™

- Clear, flexible finish
- .70 oz. (20 grams)

99-683-4851 \$46.99



### Loctite® 59330 Superflex™

- Black, flexible finish
- 2.7 oz.

99-683-59330 \$8.99

# Nose Pads

The Perfect Pad for Every Frame!



Snap-In



Screw-In



Clip On



Slide-In



Stick-On



Preadonna

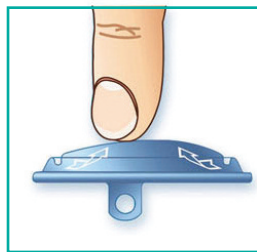
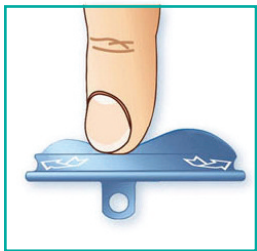
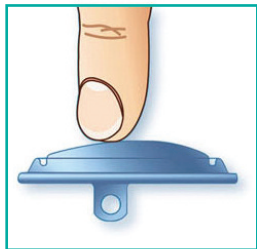

## BioFeel® Gel-Cushioned Nose Pad

\$2.99  
per pair

5 Pair  
Per Bag

World-patented BioFeel® nose pads are the most versatile, comfortable, and functional nose pads available. Why do walk-in nose pad replacements for free? Introduce customers to BioFeel® and turn repairs into profits! Your customers will thank you.

These gel-cushioned hypoallergenic pads come in a universal size and shape to minimize inventory. Once you try these problem-solver nose pads, you'll never go back to standard pads.

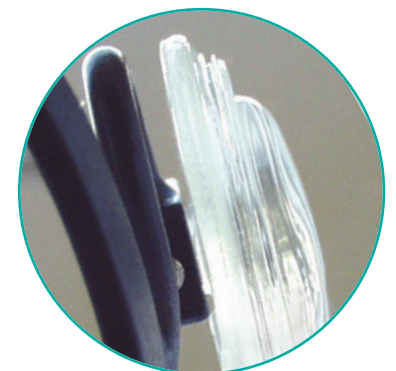
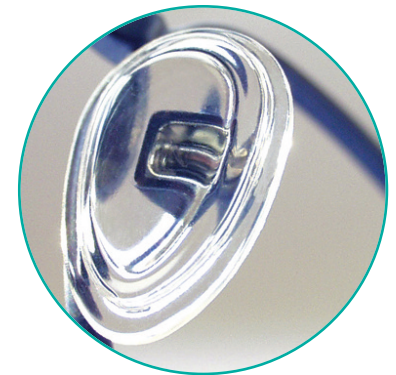
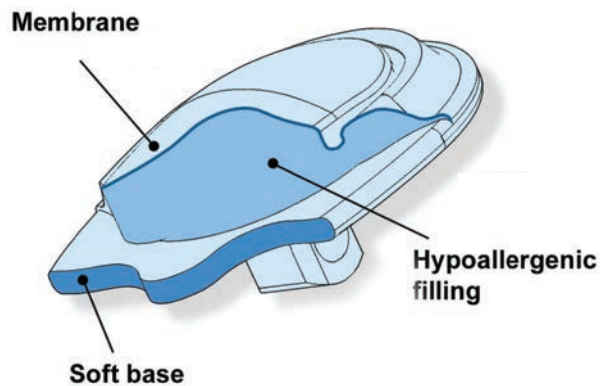

- 12.6mm Snap    33-BIOFEELSNAP
- 12.6mm Screw    33-BIOFEELSCREW

### Silicone Symmetrical Slide-In

**69¢**  
per pair  
25 Pair Per Vial

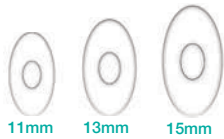

Oval

11mm	33-OS11SPI
13mm	33-OS13SPI
15mm	33-OS15SPI

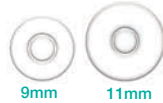

Round

9mm	33-OS9RSP1
11mm	33-OS11RSP1

### Silicone Symmetrical with Metal Insert



Silver Snap/Tear Drop

13mm	33-OS13SN-S
15mm	33-OS15SN-S



Silver Screw/Tear Drop

13mm	33-OS13SC-S
15mm	33-OS15SC-S



Gold Snap/Tear Drop

13mm	33-OS13SN-G
15mm	33-OS15SN-G



Gold Screw/Tear Drop

13mm	33-OS13SC-G
15mm	33-OS15SC-G

### Silicone D-Shape

**69¢**  
per pair  
25 Pair Per Vial



13mm 15mm



13mm 15mm



17mm 19mm



17mm 19mm

Snap

13mm	33-OS13DSN
15mm	33-OS15DSN
17mm	33-OS17DSN
19mm	33-OS19DSN

Screw

13mm	33-OS13DSC
15mm	33-OS15DSC
17mm	33-OS17DSC
19mm	33-OS19DSC

**BUY MORE, SAVE MORE!**  
Mix & Match 5 or More Nose Pad Vials\*  
From Pages 225-227, and Pay Just  
**52¢ Per Pair**

\*Priced at 69¢



### Silicone Symmetrical

**69¢**  
per pair  
25 Pair Per Vial



Snap/Round

9mm	33-OS9SN
11mm	33-OS11RSN



Screw/Round

9mm	33-OS9SC
11mm	33-OS11RSC



11mm 13mm



11mm 13mm

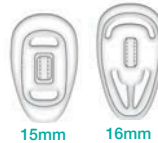

15mm 16mm



15mm 16mm

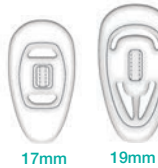

17mm 19mm



17mm 19mm

Snap/Tear Drop

11mm	33-OS11SN
13mm	33-OS13SN
15mm	33-OS15SN
16mm	33-OS16SN
17mm	33-OS17SN
19mm	33-OS19SN

Screw/Tear Drop

11mm	33-OS11SC
13mm	33-OS13SC
15mm	33-OS15SC
16mm	33-OS16SC
17mm	33-OS17SC
19mm	33-OS19SC

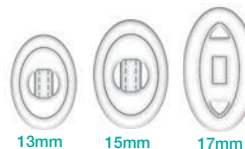

Snap/Oval

13mm	33-OS13OVSN
15mm	33-OS15OVSN
17mm	33-OS17OVSN

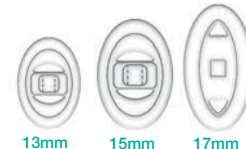

Screw/Oval

13mm	33-OS13OVSC
15mm	33-OS15OVSC
17mm	33-OS17OVSC

# FRAME PARTS

## Plastic Symmetrical

**69¢**  
per pair

25 Pair Per Vial



9mm

Snap/Round

9mm 33-OS9PN

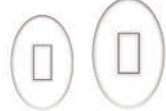

13mm 15mm

Snap/Oval

13mm 33-OS13OVPN  
15mm 33-OS15OVPN



13mm 15mm 17mm

Snap/Tear Drop

13mm 33-OS13PN  
15mm 33-OS15PN  
17mm 33-OS17PN



9mm

Screw/Round

9mm 33-OS9PC

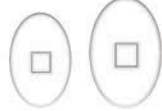

13mm 15mm

Screw/Oval

13mm 33-OS13OVPC  
15mm 33-OS15OVPC



13mm 15mm 17mm

Screw/Tear Drop

13mm 33-OS13PC  
15mm 33-OS15PC  
17mm 33-OS17PC

## Plastic D-Shape



13mm 15mm 17mm

Snap

13mm 33-OS13DPN  
15mm 33-OS15DPN  
17mm 33-OS17DPN



13mm 15mm 17mm

Screw

13mm 33-OS13DPC  
15mm 33-OS15DPC  
17mm 33-OS17DPC

## Plastic Symmetrical with Metal Insert



13mm 15mm

Silver Snap/Tear Drop

13mm 33-OS13PN-S  
15mm 33-OS15PN-S



13mm 15mm

Silver Screw/Tear Drop

13mm 33-OS13PC-S  
15mm 33-OS15PC-S



13mm 15mm

Gold Snap/Tear Drop

13mm 33-OS13PN-G  
15mm 33-OS15PN-G



13mm 15mm

Gold Screw/Tear Drop

13mm 33-OS13PC-G  
15mm 33-OS15PC-G

## Polycarbonate Superslim

**69¢**  
per pair

25 Pair Per Vial



9mm

Screw/Round

9mm 33-OS9RCPOLY



10mm

Snap/D-Shape

10mm 33-OS10DNPOLY



12mm

Snap/Oval

12mm 33-OS12OVNPOLY



12mm

Screw/Oval

12mm 33-OS12OVCPOLY

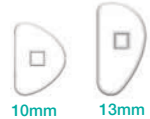

10mm 13mm

Screw/D-Shape

10mm 33-OS10DCPOLY  
13mm 33-OS13DCPOLY



12mm

Slide-In/Oval

12mm 33-OS12OVPIPOLY



13mm

Snap/Tear Drop

13mm 33-OS13NPOLY



13mm

Screw/Tear Drop

13mm 33-OS13CPOLY

## Clip On Nose Pads

**69¢**  
per pair

25 Pair Per Vial



12mm 14mm 16mm

Silver Insert

12mm 33-OS12RBS  
14mm 33-OS14RBS  
16mm 33-OS16RBS



12mm 14mm 16mm

Gold Insert

12mm 33-OS12RBG  
14mm 33-OS14RBG  
16mm 33-OS16RBG



15mm

Peach Tear Drop

15mm 33-OS15RB

## Primadonna Nose Pads

**69¢**  
per pair  
25 Pair Per Vial

### Plastic



9mm

Round  
9mm 33-OS9PR



13mm

Oval  
13mm 33-OS13OVPR



13mm

Tear Drop  
13mm 33-OS13PR

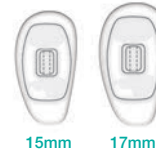

15mm 17mm

D-Shape  
15mm 33-OS15DPR  
17mm 33-OS17DPR

**BUY MORE,  
SAVE MORE!**  
Mix & Match 5  
or More Nose Pad  
Vials\* From Pages  
225-227, and Pay  
Just **52¢** Per Pair

\*Priced at 69¢

### Silicone



9mm

Round  
9mm 33-OS9SR



13mm

Oval  
13mm 33-OS13OVSR



13mm

Tear Drop  
13mm 33-OS13SR

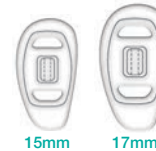

15mm 17mm

D-Shape  
15mm 33-OS15DSR  
17mm 33-OS17DSR

## Silicone Screw-to-Frame Bridges

**\$2.99**  
each  
5 Pieces Per Vial

### Silver Insert

14mm 33-OS14BRCS  
15mm 33-OS15BRCS  
17mm 33-OS17BRCS



14 x 18mm



15 x 24mm



17 x 30mm

### Gold insert

14mm 33-OS14BRCG  
15mm 33-OS15BRCG  
17mm 33-OS17BRCG



14 x 18mm



15 x 24mm



17 x 30mm

## Silicone Strap Bridge

**\$1.99**  
each  
5 Pieces Per Vial

### Screw

21.5mm 33-OS21.5SC  
30.5mm 33-OS30.5SC  
36.8mm 33-OS36.8SC



21.5 x 15mm



30.5 x 14mm



36.8 x 20mm

### Snap

21.5mm 33-OS21.5SN  
30.5mm 33-OS30.5SN  
36.8mm 33-OS36.8SN

## Stick-On Nose Pads

**99¢**  
per pair  
5 Pair Per Bag



13mm 13mm

Foam Tear Drop  
Peach 13mm 33-B302P  
Coffee 13mm 33-B302C



16mm 16mm

Foam Oblong  
Peach 16mm 33-B202P  
Coffee 16mm 33-B202C



16mm 16mm

Foam Oblong  
Peach 16 x 7mm 33-B102P  
Coffee 16 x 7mm 33-B102C



13mm 15mm

Silicone  
13mm 33-OS13SO  
15mm 33-OS15SO

## FRAME PARTS

### Lens Liners and Cords

\$9.99  
each

- For rimless and semi-rimless grooves
- Convenient dispenser



Pull liner out



Push to retract



"O" Shape Cord

.5mm x 65' 78-T16D-.50

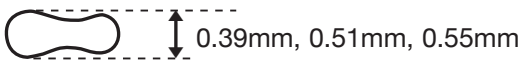

"8" Shape Liner

.39mm x 35' 78-T16E-.39

.51mm x 35' 78-T16E-.51

.55mm x 35' 78-T16E-.55

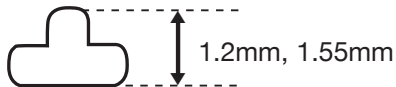

"T" Shape Liner

1.2mm x 16' 78-T16F-1.2

1.55mm x 16' 78-T16F-1.55

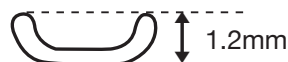

"U" Shape Interliner

1.2mm x 16' 78-T16G-1.2

### Acetate Interliner

- Fills gaps in eyewires
- .25mm x 10'



32-INTERLINER \$5.99

### Colored "O" Shape Liner

\$9.99  
each

- Use with semi-rimless frames to complement frame color
- Convenient dispenser

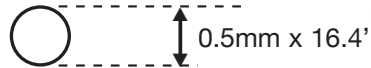

Black	44-16-1
Green	44-16-2
Blue	44-16-3
Purple	44-16-4
Yellow	44-16-5
Red	44-16-6
Pink	44-16-7
Light Brown	44-16-8
Brown	44-16-9

### Rhinestone Kit

Add rhinestones to decorate and personalize customer lenses. Kit comes complete with everything you need:

- 18 types of stones-100 each
- Permanent cement
- Hand drill

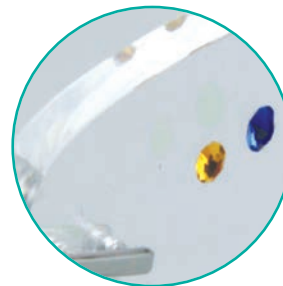

Drill the hole, inject the cement, and insert the stone



Amethyst



Sapphire



Topaz

78-TA70 \$99.99

# Frame Parts Drawer System

**\$9.99**  
each drawer

Our modular design allows for the greatest flexibility for frame parts storage. Neatly store standard screws, Snapit® screws, nose pads, temple-ends, and other frame parts in a compact footprint. Three different drawer designs are interchangeable and stackable to offer the greatest variety for your storage and organizing needs.

- Sturdy, durable plastic construction
- Stackable, interchangeable drawer designs
- Each drawer measures 6.5" (W) x 7.25" (D)

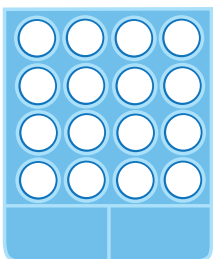

44-650-1  
Drawer for Screw Vials  
1.5" high

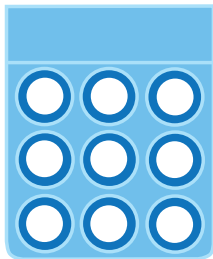

44-650-2  
Drawer for Nose Pad Vials  
3" high

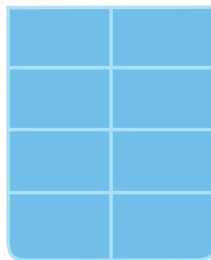

44-650-3  
Drawer for Temple Tips  
1.5" high

## Drawer System Pre-Pack Kit

A Pre-Assortment of Our Top Selling  
Nosepads, Screws, and Temple Tips  
Over 1,300 Pieces

**\$399.99**

\$512 Value



### Screws (Includes Hex Nuts and Dome Nuts)

- 1.0 x 4.2 x 1.4 Silver Standard Nose Pad Screws (100 pcs)
- 1.2 x 3.2 x 1.6 Silver Stay-Tight Nose Pad Screws (100 pcs)
- 1.3 x 9.0 x 1.8 Silver Self-Tapping Eyewire Screws (50 pcs)
- 1.4 x 9.0 x 1.8 Silver Self-Tapping Eyewire Screws (50 pcs)
- 1.4 x 4.0 x 2.0 Silver Self-Aligning Spring Hinge Screw (100 pcs)
- 1.4 x 3.8 x 1.8 Silver Stainless Steel Eyewire Screws (100 pcs)
- 1.4 x 2.5 Silver Rimless Hex Nuts (50 pcs)
- 1.4 x 2.5 Silver Rimless Dome Nuts (100 pcs)

### Snapit® Screws 50 Silver Screws each

- 1.2 x 4.0 x 1.8 Eyewire Screw
- 1.3 x 4.0 x 1.8 Eyewire Screw
- 1.4 x 3.0 x 1.8 Eyewire Screw
- 1.4 x 4.0 x 1.8 Eyewire Screw
- 1.3 x 3.5 x 2.0 Hinge Screw
- 1.4 x 3.5 x 2.0 Hinge Screw
- 1.4 x 4.0 x 2.0 Hinge Screw
- 1.5 x 4.0 x 2.0 Hinge Screw

### Nose Pads 25 pair each

- 9mm Silicone Symmetrical, Screw/Round
- 13mm Silicone Symmetrical, Screw/Oval
- 13mm Silicone Symmetrical, Snap/Oval
- 13mm Silicone Symmetrical, Screw/Tear Drop
- 13mm Silicone Symmetrical, Snap/Tear Drop
- 15mm Silicone Symmetrical, Screw/Tear Drop
- 15mm Silicone Symmetrical, Snap/Tear Drop
- 13mm Plastic Symmetrical, Screw/Tear Drop
- 13mm Plastic Symmetrical, Snap/Tear Drop

### Temple Tips 8 pair each

- 1.1mm Ultra-Thin Plastic - Black
- 1.6mm Hard Plastic Protective - Black
- 1.6mm Flared Plastic - Black
- 1.4mm Silicone Over Plastic - Black
- 1.4mm Silicone Over Plastic - Brown
- 1.4mm Silicone Over Plastic - Clear
- 2.0mm Standard Plastic - Black
- 2.0mm Standard Plastic - Brown

# Heat Shrink Temple Tubing

## Organizer Kit

Kit contains an assortment of black, clear, brown, and gray shrink tubing in two convenient sizes (1/8" and 3/16" x 4"). Each color and size is separated by a labeled compartment, while the hard plastic case provides easy storage.

- Four colors, 80 pieces total
- Shrinks to 1/3 of its original size
- For use with Hot Air Frame Warmers

99-290-1 \$37.99



**\$3.99**  
per bag

## Refills

Packaged 10 Pieces Per Bag

### 1/8" x 4" Refills

Black	99-290-2
Clear	99-290-3
Brown	99-290-4
Gray	99-290-5

### 3/16" x 4" Refills

Black	99-290-6
Clear	99-290-7
Brown	99-290-8
Gray	99-290-9



## Ear-Lock Temple Ends

**\$14.99**  
5 pair

### Temple Ends Sized for Adults and Children

Provide your patients with a new solution for eyewear slippage with our removable silicone temple locks.

- Eliminate the need for cable temple ends
- Available in 6 popular colors
- Material: Silicone



### Children

Overall length: 20mm  
Core diameter: 2.5 x 2mm

Red	44-650-31
Pink	44-650-37
Yellow	44-650-33
Purple	44-650-36
Blue	44-650-42
Light Blue	44-650-39
Green	44-650-40
Black	44-650-32
White	44-650-34
Brown	44-650-41
Orange	44-650-38
Red Pink	44-650-35



### Adult

Overall length: 37mm  
Core diameter: 5.8 x 2mm

Yellow	33-ELTE-YL
Pink	33-ELTE-PK
Black	33-ELTE-BK
Blue	33-ELTE-BL
White	33-ELTE-WH
Brown	33-ELTE-BR





## Cable Conversion Ends

\$8.99  
2 pair

These German silicone tips are the go-to solution for eyewear slippage. The core size diameter fits a wide range of frames and are available in a variety of colors.

- Great for active people of all ages
- 1.4mm core diameter



Children

Adult

Children

Black	03-85.6483B
Chocolate	03-85.6483C
Blue	03-85.6483N
Pink	03-85.6483P

Adult

Black	03-85.6295B
Chocolate	03-85.6295C
Navy	03-85.6295N
Red	03-85.6295R
White	03-85.6295W

## Foam Temple Pads

\$3.99  
4 pair

Soft, self-adhesive foam temple pad reduces slipping and provides a comfortable cushion behind the ear.



Foam/Tear Drop

19 x 8mm

Peach	33-B203P
Coffee	33-B203C



Foam/Oblong

19 x 9.5mm

Peach	33-B103P
Coffee	33-B103C

## Temple Tips

\$5.99  
8 pair

Replacement Temple Ends for Wire Core Frames

### Standard Plastic

- 2.0mm core diameter



Clear	99-OSTT108/2000	Brown	99-OSTT108/1000
Black	99-OSTT108/0000	Gray	99-OSTT108/5000
Tortoise	99-OSTT108/6000		

### Plastic Rectangular Core

- 1.2 x 2.6mm core diameter



Black	99-OSTT109/0000	Brown	99-OSTT109/1000
-------	-----------------	-------	-----------------

### Silicone Over Plastic

- 1.4mm core diameter



Clear	99-OSTT107/2000	Brown	99-OSTT107/1000
Black	99-OSTT107/0000	Gray	99-OSTT107/5000
Tortoise	99-OSTT107/6000		

To select the correct size replacement temple tip, use the following method:

1. Straighten the temple
2. Heat and remove the temple tip
3. Measure the core wire diameter with a caliper
4. Choose from our extensive collection

### Flared Plastic

- 1.6mm core diameter



Clear	99-OSTT106/2000	Brown	99-OSTT106/1000
Black	99-OSTT106/0000	Gray	99-OSTT106/5000
Tortoise	99-OSTT106/6000		

### Hard Plastic Protective

- 1.6mm core diameter



Black	99-OSTT124/0000	Brown	99-OSTT124/1000
-------	-----------------	-------	-----------------

### Ultra-Thin Plastic

- 1.1mm core diameter



Clear	99-OSTT86/2000	Tortoise	99-OSTT86/3000
Black	99-OSTT86/0000	Brown	99-OSTT86/1000

- Premium handmade acetate
- Available in 17 popular shapes and Colors
- 1.4mm core diameter

## Acetate Temple Tips

\$5.99  
2 Pair



Red 99-282-1



Pink 99-282-2



Caramel 99-282-3



Teal 99-282-4



Green 99-282-5



White 99-282-6



Yellow Tortoise 99-282-7



Pink Tortoise 99-282-8



Purple 99-282-9



Navy 99-282-10



Pink Duotone 99-282-11



Ivory 99-282-12



Brown 99-282-13



Gray 99-282-14



Steel Blue 99-282-15



Black 99-282-16



Steel Blue 99-282-17



# Silicone Temple Tips

\$7.99  
8 Pair



Black (Thin) 1.0mm 44-650-11



White (Thin) 1.0mm 44-650-12



Clear (Thin) 1.0mm 44-650-13



Red 1.0mm 44-650-16



Black 1.0mm 44-650-17



Gray 1.0mm 44-650-18



White .9mm 44-650-10

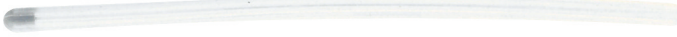

Clear (Thin) .9mm 44-650-14



Black (Thin) .9mm 44-650-15



Black 1.4mm 44-650-22



Blue 1.4mm 44-650-20



White 1.4mm 44-650-19



Brown 1.4mm 44-650-21



# Rubber Temple Tips

\$7.99  
8 Pair



Gray 2.7 x 0.8mm 44-650-23



Black 2.7 x 0.8mm 44-650-24



White 2.7 x 0.8mm 44-650-25



Blue 2.7 x 0.8mm 44-650-26

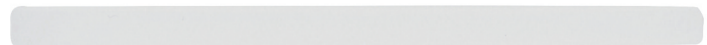

White 3.0 x 0.8mm 44-650-27



Gray 3.0 x 0.8mm 44-650-28



Black 3.0 x 0.8mm 44-650-29



Brown 3.0 x 0.8mm 44-650-30

<b>0-9</b>	
1.53 Index Lens Clock	215
3-in-1 Lens Inspection Station	171
3M Blocks	149
3M Hydrophobic Pads	142
3M Leap Pads	142
3M Press-On Lenses	90
3M Surface Saver Knife Blade Handle	132
3M Surface Saver Tapes	132-133
9-Pan Tinting System	163
9-Piece Deluxe Screwdriver Set	205
<b>A</b>	
Acetate Lens Inteliners	228
Acetate Temple Tips	232
Acetone	176
Acrylic Demo Lenses	102
Adjustment Pliers	180-199
Air Duster	103
Alcohols	176, 178
Alcohol Pads	124
All Off Marking Ink Remover	129, 177
Alloy	128
Angling Pliers	181, 185, 191, 194, 196, 198, 213
Anti-Fog Lens Cleaner	8
Anti-Slip Edging Solutions	142, 146-147
Anvil Bench Block	211
AR Coating Consumables	128
AR Remover	176
Automatic Lens Edge Polisher	155
Automatic Lens Groover	22
<b>B</b>	
Backside Coating	130
Bags	94-95
Ball Bearing Screwdrivers	204
Ball Cutters	138
Basic Cloths	10
Basic Reader Collection	54-55
Batteries	126
Bench Blocks	210-211
Bent Post Pliers	184
Beveling Tool	209
Bifocals - Stick-On	91
BioFeel Nose Pads	224
Bionic Thumb	211
Blade Readers	44
Blades	204-205
Blocking Alloy	128
Blocking Pads	142-145
Blocks	148-149
Blue Chip Lens Protectors	142
Boutique Bags	94
BPI Dyes	168
Bridge Reducing Pliers	184
Buffing Pads	156
Bulbs	125-126
Bushings	220-221
<b>C</b>	
Cable Conversion Ends	231
Cablz Retainers	87
Cad-Con 1000	128
Calipers	215
Camera Phone Slit Lamp Adapter	106
Carbide Blades	152
Cases	20-30
Chain Nose Pliers	183, 185, 187, 192, 195, 198, 199
Chains	78-85
Chamfer Tool	209
Chamois Cloths	16
Charts, Exam	111
Chem Tempering Salts	130
Children's Sunglasses	63
Children's Eye Patches	118
Children's Temple Ends	230-231
Chin Rest Papers	112
China Markers	172
Chuck Protectors	146
Clamshell Cases	20-26
Clavulus Hand Press	210
Cleaners	4-9
Cleaning Cloths	10-16
Clear Label Lens Cleaner	5
Clear Lens Protectors	146
Clear View Lens Cleaner	5
CliC Magnetic Readers	56-62
Clip-Ons	64-70
Cloths	10-16
Cobalt King Blocking Pads	143-145

Cold Dip Scratch Coat	164
Compression Sleeve Pliers	180-181, 191, 193, 196, 213
Compression Sleeve Removal Tool	209
Compression Sleeves	221
Contact Lens Cases	119-122
Contact Lens Handling	122
Coolant	153
Coolant Pumps	152
Cords	75-87
Cosmetics	88-89
CR-39 Neutralizer	165
CR-39 Polarized Plano Lenses	159
CR-39 Test Lenses	149
Crimp-On Nose Pad Pliers	183, 197
Crimson King Blocking Pads	143-145
Crown Salt	130
Curved Plastic Tool Rack	201
Custom Clean	6
Cutter Blades	152, 138
Cutting Pliers	188-189, 191, 195, 200
Cylinder Machine Reception Chucks	138

**D**

D-Clips Clip-Ons	67
Deblockers/Deblocking Pliers	149, 189, 191, 195
Defoamers	130, 153
Demo Lenses	102
Denatured Alcohol	176
Deodorizer	164
Designer Cloths	13
Diamond Tooling	139
Digital Caliper	215
Dispensary Cloth	16, 103, 178
Dispenser Bottle	176
Dispensing Bags	94-95
Dispensing Trays	98
Displays	8, 32-41, 96-98, 166, 196-197
Distometer	108, 216
DMV Products	122
Dome Nuts	221
Dome-Top Flat Packs	119
Double Spindle Bench Polisher	155
Drawers	229
Drill Bits	209
Dry AR Remover	176

Dry Eye Mask	113
Dry Dye Packets	166
Dry Eye Sunglasses	71
Dye Cleaner / Remover	170
Dye Unit	163
Dyes	162, 166-168

**E**

Ear-Lock Temple Ends	230
Economy Blue Blocking Pads	143-145
Edge Pens	154, 170
Edge Polish	154
Edge Polisher	155
Edger Chucks	149
Edger Coolant	153
Edger Pumps	153
Edging Blocks	148-149
Edging Pads	142-145
Edging Wheels	150
Elite Collection - Readers	52
Exam Equipment	106-112
Eye Charts	111
Eye Compress Mask	113
Eye Patches	116-118
Eye Protection	114-118
Eye Shields	114-116
Eyeglass Cases	20-30
Eyeglass Holders	32-41, 75-87, 92, 96-97
Eyeglass Lights	92
Eyeglass Repair Kit	92, 218
Eyeglasses Patches	117
Eyeglasses Retainers	75-87
Eyewear Displays	32-41, 96-98
Eyewire Pliers	182, 190, 194, 196, 212
Eyewire Screws	218-223

**F**

Figure 8 Interliner	228
Files	208
Fining Pads	134-136
Finishing Wheels	150
Fits Over Sunglasses	71-73
Flat Packs	119
Flip-Top Flat Packs	119
Foam Temple Pads	231

Fog Free Lens Cleaner	8
Folding Reading Glasses	42-44
Frame Bending Tool	211-212
Frame Displays	96-98
Frame Parts Drawer System	229
Frame Repair Tools	210-211
Frame Tags	102
Frame Warmers	104, 161

**G**

Generator Blades / Wheels	138
Gift Kits	4-7
Glass Beads	104, 161
Gloves	130, 170
Glue Remover	102
Gradient System	163
Gripping Pliers	186-187, 192-193, 199, 213
Groover	157
Guardian Safety Eyewear	74

**H**

Hammer / Mallets	206
Hand Cleaner	170
Hand Edger Wheels	150-151
Hand Edger	151
Hand Tools	180-216
Handle Sleeves	201
Hang Aroundz Readers	45
Hardcoat	130
Head Displays	98
Heat Shrink Temple Tubing	230
Heat Transfer Fluid (HTF)	165
Helping Hands	210
Hex Nut Wrenches	204
Hex Nuts	221
Hinge Screws	219, 222-223
Hockey Puck	210
Holiday Microfiber Cloths	14-15
Honing Sticks	152
Hook-On Sunglasses	115
Horizon Cutter Blades	152
Horizontal Prism Bar	112
Hot Air Frame Warmer	104, 161
Hot Dip Scratch Coat	164
HTF	165

Hydro King Blocking Pads	142-145
Hydrophobic Edging Solutions	142, 146-147
Hydrophobic Pads	143-146

**I**

Imprinting	4-18, 20, 119
Inclination Pliers	185
Ink Marking Removers	129, 176-177
Interliner	228
Intermediary Film Pads	147
Ishihara Book	112
Isopropyl Alcohol	178

**J**

Job Tray Cleaner	131
Job Trays	131

**K**

Key Chain Screwdriver	4
Kimwipes	17, 103
Kool Klean Kit	7

**L**

Lab Fresh	164
Lab Size Cloths	16, 178
Lab Snips	206
Lady's Pliers	193-195
Laps	138
Latex Gloves	130, 170
Leap Pads	142-145
Lead and Cadmium Stabilizer	128
Lens Aligning Pliers	181, 191, 194, 196
Lens Alignment Gauge	214
Lens Calipers	215
Lens Cleaner Kits	4-9
Lens Cleaner Refill	8, 178
Lens Cleaners	4-9
Lens Clocks	57
Lens Display	166
Lens Dyes	162, 166-168
Lens Edge Pen	170
Lens Edge Polishers	155
Lens Groover	22
Lens Holders	164

Lens Hole Gauge	215
Lens Inspection Station	171
Lens Inspection Systems	107, 171, 173, 174
Lens Interliners	228
Lens Marking Inks / Pens	107, 172
Lens Pens	172
Lens Polishes	137, 154
Lens Prep	164
Lens Protection Discs	142, 146
Lens Screw Holding Pliers	181
Lens Sizing Pliers	183
Lens Wipes	17, 103
Lensometer	107, 173
Lensometer Ink	107, 172
Line Hook	209
Little Giant Submersible Pumps	152
Loctite	223
Low Vision Aids	90-91

**M**

Magnetic Tool Holder	201
Magnifiers	90
Mallet	206
Markers	172
Marking Ink Removers	129, 176-177
Marking Inks	107, 172
Mask - Eye Compress	113
Matched Wheels Set	150
Mechanical Gradient System	163
Micro Specs	42
Microfiber Cloths	10-16
Microfiber Pouches	16
Milling Tooling	139
Mini Clean	9
Minishades	63
Mirrors	99-101
Moisture Chambers	116
MultiMeter	174

**N**

Necklace Eyeglass Holders	84-85
Neon Cloths	12
Neutralizers	165
Nitrile Gloves	130, 170
Nose Guard	116

Nose Pad Pliers	183-184, 192, 194, 197
Nose Pad Screws	223
Nose Pads	224-227, 229
Numont Pliers	184
Nut Gripper	205
Nuts	221
Nylon Gripping Pliers	186-187, 190, 192, 193-194, 199
Nylon Jaw Pliers	186, 190, 192, 194, 198-199, 213

**O**

Occluders	114
Ophthalmic Products	123-124
Optical Displays	96-98
OptiPets / OptiNoses	32-41
Optitile Display System	98

**P**

PAL Fitting Tool	108, 216
PAL Identifier	171
Paper Bags	94
Paper Temple Sunglasses	115
Pattern Blanks	153
PCD Cutters	139, 152,
PD Meters	109
PD Rulers	108, 216
Peeper Keepers Eyewear Holders	75-79
Pen Lights	110
Pharmaceuticals	123-124
Phone Adapter for Slit Lamp	106
Photochromic Salt	130
Pint-Size Pans and Lids	164
Plano Lenses	158
Plastic Bags	95
Plastic Blocks	148-149
Plastic Laps	138
Plastic Nose Pads	226-227
Plastic Test Lenses	149
Plier Sleeves	201
Pliers	180-203, 212-213
Pod Reading Glasses	44
Polariscope	171
Polarized Minishades	63
Polarized Plano Lenses	158-159
Polish Off	131
Polishes	137, 154

Polishing Machine	155
Polishing Pads	156
Polishing Pads	45-49, 134-136
Polishing Pen	154, 170
Polishing Sticks	154
Polishing Wheel	150
Polycarbonate Dyes	167
Polycarbonate Edge Glaze	154
Polycarbonate Polarized Lenses	159
Post-Mydriatics	115
Preferred Collection - Readers	46-51
Premoistened Lens Wipes	8
Press-On Lenses	90
Prism Bar	112
Progressive Marking Ink Remover	129, 177
Pupilometers	109

**R**

Reach Nuts	220
Reading Glasses	42-62
Reception Chucks	138
Replacement Blades	204
Retail Bags	94-95
Retainers	75-87
Retruing Service	152
RevitaLash Cosmetics	88-89
Rhinestone Kit	228
Riki Pad and Film	146
Rimless Assembly Measuring Tool	214
Rimless Bushings	220, 223
Rimless Caps	220
Rimless Compression Sleeves	221, 223
Rimless Driver-Bit Set	209
Rimless Hardware / Screws	220, 223
Rimless Omni-Nut Assembly	220
Rimless Pliers	180-181, 191, 193, 196
Rimless Tools	180-214
Rimless Screws	220
Rimlon Cord Tool	212
Riveting Hammers	206
Roll Up Sunglasses	115
Rouge	154
Roughing Wheels	150
Rubber Temple Tips	233
Rx Swimming Goggles	74

**S**

Safety Eyewear	74
Salt Pan Frame Warmer	104, 161
Salts	130
Sani-Cloth	124
Scratch Coat	164
Screw-Top Contact Lens Cases	120
Screw Extraction Pliers	186, 198
Screw Flaring Closure Pliers	182
Screw Extractor Kit	207
Screw Finisher Tool	209
Screw Gripper	205
Screwdriver w/Gripper	205
Screwdriver Set	205
Screwdrivers	204-205, 212
Screws	218-223
Scribe Tool	209
SecurEdge Blocking Pads	143-145
Self-Aligning and Self-Tapping Screws	222
Semi-Hard Cases	26-27
Semi-Rimless Pliers	180-200
Shade Control Clip-Ons	68-70
Shrink Tubing	230
Silicone Nose Pads	225-227
Silicone Temple Tips	203
Sleeved Hinge Screws	223
Slim Spex	43
Slip-In Cases	28-30
Slip-In Post-Mydriatics	115
Slit Lamp Camera Phone Adapter	106
Snapit Eyeglass Repair Kit	92, 218
Snapit Screws	218-219
Snipe Nose Pliers	185, 187, 192, 195, 198, 200
Snips	206
Soft Slip-In Cases	28-30
Soft Flip-Top Cases	30
Solar Shields	71-73
Soldering Clamps	206
Solvents	129, 176-178
Specialty Reading Glasses	42-45
Spin-On UV-Hardcoat	130
Spring Hinge Screws	222
Squeeze Lens Cleaner	8
Standard Reading Glasses	46-55
Star Nuts	221
Stick-On Nose Pads	227
Stick-On Bifocals	91
Sticker Remover	102
Submersible Pumps	152



Sun Clips	64-70
Sunglass Flat Packs	119
Sunglass Wall Mirror	99
Sunglasses	63-73
Super Hydro Anti-Slip Spray	147
Super IFP	147
Surface Saver Blades	132
Surface Tapes	132-133
Surfacing Pads	134-136
Swimming Goggles	74
Swinger Mirror	99

**T**

Table Edge Bench Block	209
Tabletop Lumifier	90, 210
Tabletop Mirrors	100-101
Tabletop Tool Holder	201
TAC Polarized Plano Lenses	158
Tags	102
Tape Dispenser System	132
Tempering Salts	130
Temple Bending Pliers	185, 197
Temple Bending Tools	211-212
Temple Locks	230-231
Temple Tubing	230
Temple Tamer	212
Temple Tips / Ends	230-233
Test Lenses	149
Three-Piece Adjusting Pliers	181, 196
Tin Pans / Lids	164
Tint Display	166
Tinting Lens Holders	164
Tinting Unit	163
Tints	162, 166-168
Titanium Pliers	190-191
Tool Cases	201
Tool Holders	201
Tool Kits	202-203
Tool Sleeve Replacement	201
Top Hats	220
Tray Cleaner	131
Trays	131
Tri Acetate Cellulose Plano Lenses	158
Trial Frame	110
Trial Lenses	110

Truing Sticks	152
Tweezers	206

**U**

Ultimate Collection - Readers	53
Ultra Thin Clip-On Sunglasses	64-66
Ultrasonic Cleaners	174-175
Ultrasonic Cleaning Fluid	175
UV Dyes	166
UV Formulas	169
UV Hardcoat	130
UV Meter	174

**V**

Vertexometer	216
Vertical Prism Bar	112
Visor Clips	92

**W**

Wall Mirror	99
Washers	221
Wave Lens Cleaners	5
Wave Cloths	12
Wayfarer Sunglasses	63
Weco Blocks	148-149
Western Optical Tools	212-213
Wheels	150
Wood and Plastic PD Ruler	216

# Terms and Conditions

## Copyright and Trademark Information:

The materials contained in this catalog are copyright 2008 OptiSource International, Inc. You may not distribute, modify, transmit, reuse, report, or use the contents of the catalog for public or commercial purposes, with the exception of brief quotes in professional or trade publications. OptiSource is a registered trademark of OptiSource International, Inc. All trademarks appearing herein are acknowledged. The name of OptiSource International, Inc. or any of the trademarks or logos used herein may not be used in any manner without specific, written prior permission. You should assume that everything you see or read in this catalog is copyrighted or subject to trademark protection, unless otherwise noted, and may not be used except as provided in these Terms and Conditions without the written permission of OptiSource.

## General Information:

The information contained in this catalog is subject to change without notice. While OptiSource has used reasonable efforts to include accurate and up-to-date information, OptiSource makes no warranties or representations as to its accuracy. OptiSource assumes no liability or responsibility for any errors or omissions in the content. OptiSource may at any time revise these Terms and Conditions. You are bound by any such revisions. In the event a product is listed at an incorrect price or with incorrect information due to typographical error or error in pricing or product information received from our suppliers, OptiSource shall have the right to refuse or cancel any orders placed for product listed at the incorrect price. OptiSource shall have the right to refuse or cancel any such orders whether or not the order has been confirmed and your credit card charged. If your credit card has already been charged for the purchase and your order is canceled, OptiSource shall immediately issue a credit to your credit card account in the amount of the charge.

## Warranties:

Every third-party product you buy from OptiSource is backed first by the product manufacturer's warranty. OptiSource's 30-day limited warranty against defects may also apply. That warranty provides for either repair or replacement (at OptiSource's sole discretion) of merchandise confirmed as defective by either the manufacturer or OptiSource. We will assist customers whenever possible in gaining satisfaction with product manufacturers. No returns will be accepted when the manufacturer's or distributor's return policies supersede ours.

## Order Acceptance Policy:

All orders are accepted in accordance with the Terms and Conditions set forth herein. OptiSource reserves the right at any time after receipt of your order to accept or decline your order for any reason. OptiSource reserves the right at any time after receipt of your order, without prior notice to you, to supply less than the quantity you ordered of any item. All orders placed over USD \$2,000 must obtain credit pre-approval.

Following acceptance by Seller, orders are not subject to cancellation or modification, except upon written approval by Seller, and shall be subject to cancellation charges. OptiSource reserves the right to correct and amend any typographical errors.

All orders placed by the Buyer are binding. Buyer agrees that Buyer is wholly responsible for the actions of Buyer's employees, agents or representatives. If an employee of Buyer places an order unbeknownst to its management, Buyer is responsible for said person's actions, and Buyer assumes all responsibilities, whether authorized or not. Following written acceptance of or by signing for packages, Buyer agrees that Buyer authorized the purchase and accepts the terms and conditions of the sale with Seller. The Buyer's employee, agent or representative is acting on behalf of the Buyer, and by signing and receiving the package, the Buyer agrees to the Terms and Conditions of purchase and is responsible for payment of the merchandise.

Buyer is hereby notified that for the purposes of quality control, training, order and shipping accuracy, Seller may monitor agreements to purchase. This agreement is the policy of the Seller. This policy supersedes any arrangement the Buyer may have with a third-party billing or buying group. This policy is non-negotiable and cannot be modified or compromised at any time by anyone, including Seller's employees or any buying group.

## Limitations of Liability and Indemnity:

In no event shall OptiSource or any of its subsidiaries or affiliates be liable for any indirect, special, incidental or consequential damages, including but not limited to loss of use, loss of data, loss of business, or loss of profits. Some localities do not allow the exclusion or limitation of incidental or consequential damages, so the above limitation or exclusion may not apply to you. Seller assumes no liability for damage and/or injury resulting from use or misuse of equipment or supplies supplied by Seller. In no event will Seller be liable for indirect or consequential damages whatsoever resulting from loss of use, data or profits arising out of, or in connection with, the use or misuse of Seller's product. Buyer agrees to indemnify and hold the Seller harmless for any expense or loss arising out of, or resulting from, the installation of said product by Buyer.

## Return of Product and Refused Shipments:

All return claims must be made within 30 days of receipt of goods. All returns must be authorized by OptiSource and accompanied by a Return Authorization number. Claims for damages and shortages must be made within 15 days of the date of delivery. All returns must be shipped freight prepaid by Buyer. Absolutely no returns will be accepted after 60 days of receipt of goods. All unauthorized returns will be refused by Seller. All authorized returns are subject to a restocking and transportation fee of 25% of the entire invoice in question, unless Buyer chooses to exchange for another comparable product. Any products omitted from returned package will automatically be billed at full price. All free items must be returned with original invoice. Returns are subject to Seller's prior inspection and analysis to verify that merchandise has not been mishandled, altered or contaminated in any way. All products returned to Seller due to refusal of acceptance by Buyer, without Seller's authorization, will be subject to a 25% restocking and transportation charge.

Special-design and custom-constructed or custom-formulated merchandise is not returnable. Contact customer service for return authorization at 1-800-OPTISOURCE (678-4768).

3 Easy Ways To Order...

1-800-OptiSource (678-4768) Fax 631-924-8375 [www.1-800-OptiSource.com](http://www.1-800-OptiSource.com)



Screw it in

Snap it off

Every hinge. Every eyewire. Every job!

**Snapit**  
frame screws

1-800-OptiSource (678.4768)

**OptiSource**  
International  
The Optical Supply Resource

1-800-OptiSource.com

U.S. Patent Numbers 8070403, 8375546, 8556556, 8997327



**The Optical Supply Resource**

40 Sawgrass Drive, Bellport, NY 11713 USA

1-800-OptiSource (678-4768)

International: 631-924-8360

Fax: 631-924-8375

1-800-OptiSource.com

info@1-800-OptiSource.com