

CHEMISTRY



MACHINERY



EDGING



SURFACING



TOOLS



FRAME PARTS



EXAM SUPPLIES



ACCESSORIES



LENS CLEANERS



# THE OPTICAL SUPPLY RESOURCE



# Over 1 Million Sold



Thank you to our loyal customers for making All Off the most widely used marking ink remover.





# CONTENTS

The Optical Supply Resource

**CHEMISTRY** pages 3-14

---

**MACHINERY** pages 15-24

---

**EDGING** pages 25-40

---

**SURFACING** pages 41-54

---

**TOOLS** pages 55-90

---

**FRAME PARTS** pages 91-106

---

**EXAM SUPPLIES** pages 107-124

---

**ACCESSORIES** pages 125-202

---

**LENS CLEANERS** pages 203-217

---

**INDEX** pages 218-221

---

**TERMS AND CONDITIONS** page 222

---

**NOTES** pages 223-224

---

# Thin is in



## Innovative Clip-On System from Kodak Lens



We've taken all of the weight out of clunky clip-on sunglasses and improved the design and function. Our new .7mm polarized lenses are HALF the thickness of traditional clip-on lenses. The proprietary hook system uses no fasteners and fits all frame styles.

- .7mm thin AR/Polarized lenses
- Unique hook system uses no screws or rivets
- Flexible nose bridge replaces unsightly brow bar



### Clip-On Sunglasses



# 5 Big Reasons

## To Sell Kodak Lens Folding Reading Glasses



1. **Brand:** Kodak is a brand that your patients trust
2. **Size:** Micro-size easily stashes in pockets, purses, glove boxes, and more
3. **Quality:** Spring hinges, permanent nose pads, and patented telescoping temples
4. **Stylish:** Patients love the look and feel
5. **New Add-On Sale:** Especially for newly diagnosed presbyopes



### Folding Reading Glasses





# CHEMISTRY

Creative Solutions

OptiSource was founded over 20 years ago as a leader in biodegradable lab chemicals. Our collection of tinting, cleaning, and lens-marking products continues to grow and evolve today. Although we are now a diverse supply company, one of our main areas of focus continues to be innovating Creative Solutions for use with today's changing lenses and coatings.



## Milky Way UV



Milky Way is the world's only white UV solution. This special white formula is clearer than any other UV. Guaranteed to be the clearest UV you've ever used or your money back.

- AR-compatible – will not yellow, even after lens is AR coated
- Unique white UV formula makes it impossible to yellow any lens
- Provides 100% protection at 380 nm
- 8 oz. concentrate (makes one quart)

99-MWUV \$69.99

## No Yellow Ultra Kote UV



Guaranteed to provide 100% UV protection up to 400 nm with virtually no yellowing.

- UV with scratch-coat combination
- Resists boiling; perfect for high altitudes
- 8 oz. concentrate (makes one quart)

99-UKUVNY \$79.99

## UV-AR



UV-AR is our newest solution to help with post-AR yellowing. Many UVs will appear clear on the lens, then turn yellow after AR treatment. Our UV-AR helps keep lenses from yellowing.

- Crystal-clear formula
- Goes on clear, stays clear after AR
- 8 oz. concentrate (makes one quart)

99-UVAR \$69.99

## No Yellow UV



Guaranteed to provide 100% UV protection up to 400 nm with virtually no yellowing.

- Resists boiling; perfect for high altitudes
- 8 oz. concentrate (makes one quart)

99-CEUVNY \$69.99

## Ultra Kote UV



Combines UV and scratch-coat protection into one simple process with no baking or curing required.

- Produces a clear, UV-protected lens with improved scratch resistance
- 8 oz. concentrate (makes one quart)

99-UKUV \$79.99



## Clear Eclipse UV



Clear Eclipse is powderless! The most advanced all-around UV formula available today... a non-clumping, fast-acting solution.

- Blocks 100% of UVA and UVB to 400 nm
- Our best-selling UV formula
- 8 oz. concentrate (makes one quart)

99-CEUV \$69.99

## Clean & Clear Ultra Kote UV



Totally crystal-free UV formula. This non-clumping UV solution stays cleaner in the pan and looks clearer on the lens.

- UV with scratch-coat combination
- Lasts longer and reduces crystals
- 8 oz. concentrate (makes one quart)

99-CCUKUV \$79.99

## Clean & Clear UV



This UV will not clump or crystallize in the pan. Eliminates popping and spattering for a safer work area. Rinses clean to produce incredibly clear lenses.

- Powderless in the bottle, powderless in the pan
- 8 oz. concentrate (makes one quart)

99-CCUV \$69.99

## AR Remover

Quickly remove unwanted or faulty Anti-Reflective coatings with our highly effective formula while patients wait! Save time and improve service.

In just 10 seconds, you can remove most AR coatings and have your patients on their way.

- The all-in-one AR Remover Kit includes an all-plastic lens holder built into the lid, chemical resistant gloves, and protective goggles (compatible with liquid or dry AR remover)
- Dry AR is our concentrated formula which provides the safest way to ship, store, and handle AR remover (mixes with water to make 1 pint)



### AR Remover Kit

Kit	99-ARKO	\$24.99
Kit w/Dry AR	99-ARK	\$74.99

### Liquid AR Remover

8 oz.	99-AR	\$59.99
Quart	99-ARQ	\$199.99

### Dry AR Remover

Each	99-ARC8	\$59.99
3-Pack	99-ARC8-3	\$129.99



### Nu-Kote Hot Dip Scratch Coat

This revolutionary hot-dip scratch coating is applied just like tint and bonds within the pores of the lens.

- Improve lens hardness in just seconds
- Easy to use; no special machinery necessary
- Simple dip-and-rinse process

Gallon	99-SK	\$59.99
Quart	99-SKQ	\$19.99



### Cold Dip Scratch Protectant

It's much harder to scratch lenses when dirt, dust, and debris won't stick! No heating or special machinery necessary.

- Simple dip-and-rinse process at room temperature
- Instantly applies a super-slick coating
- Quart

99-HDCDSK	\$59.99
-----------	---------



### Piña Colada Lab Fresh

Our scented solution will mask the worst chemical smells with fresh, light aromas.

- A few drops does it all
- No more chemical odors in your lab
- Use in tint units and recirculating systems
- 8 oz.

99-PCF	\$19.99
--------	---------





# The Original All Off Marking Ink Remover

Remove the Most Stubborn Progressive Ink Markings in Just 3 Seconds Flat!

Instantly dissolve and remove any progressive ink marking with the industry's most widely used solution. It is safer than acetone and will never ruin polycarbonate lenses. Our award-winning product is used by more labs than any other marking ink remover in the world.

- The industry standard for ink removal
- Acetone-free and safe on polycarbonate lenses
- No scrubbing; eliminates unwanted micro scratches
- Dries instantly; no oily residue

## Easily Erase Progressive Ink Markings with Our Handy All Off Pen

The unique valve-action mechanism dispenses All Off to the ink-absorbing tip. Simply press down and rub away the most stubborn ink markings in just seconds.

16 oz.	99-AO	\$59.99
4 oz.	99-AO4	\$14.99
Pen	99-AOP	\$19.99

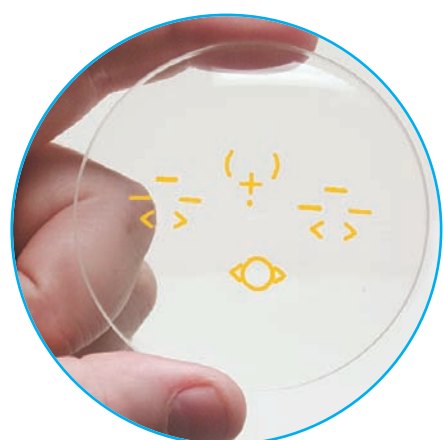

Before



After



## Heat Transfer Fluid

With Built-in Corrosion Inhibitors

Our HTF is completely odorless and biodegradable, making it safe for the user and the environment. Plus, it prolongs the life of your tint machine with its corrosion inhibitor chemistry.

- Drain-safe biodegradable
- Self-cleans with special dye neutralizers – fluid stays clean longer
- Change HTF every six months for optimal performance

Gallon	99-HTF	\$69.99
Quart	99-HTFQ	\$24.99
Battery Operated Siphon Pump	99-SP	\$19.99



## Nu-Tralizer

Safely Remove Tint from All Lenses

An odorless neutralizing compound that reduces and removes tint from CR-39, high-index, polycarbonate, and Trivex® without compromising any hard coatings.

- Safe against streaking and crazing on all lens coatings
- Drain-safe biodegradable

Gallon	99-NUT	\$69.99
Quart	99-NQ	\$24.99



## CR-39 Nu-Tralizer

Fast-Acting Formula

Rapidly remove tint from CR-39 and high-index materials. Dark colors or old lenses are no problem.

- Unique self-cleaning formula
- Drain-safe biodegradable

Gallon	99-CR	\$69.99
Quart	99-CRQ	\$24.99



## Water-Based Nu-Tralizer

Water-Based Nu-Tralizer is our safest solution for tint removal. Feel confident using it on all lenses and coatings.

- Drain-safe biodegradable
- 8 oz. concentrate (makes one quart)

99-NUTH2O	\$11.99
-----------	---------

# Color-Stabilized Lens Dyes

\$9.99 each

Long-Lasting Dyes Provide Bright and Consistent Colors



## Customer Favorite Colors



OptiSource is a leader in the optical tinting industry, using cutting-edge technology to produce chemically superior dyes. The use of dye-stabilizing chemistry produces fast-absorbing dyes that provide consistent colors from bottle to bottle and lens to lens.

- Consistent no-shift colors
- Non-toxic and biodegradable
- 4 oz. concentrate (makes one quart)

## Additional Colors

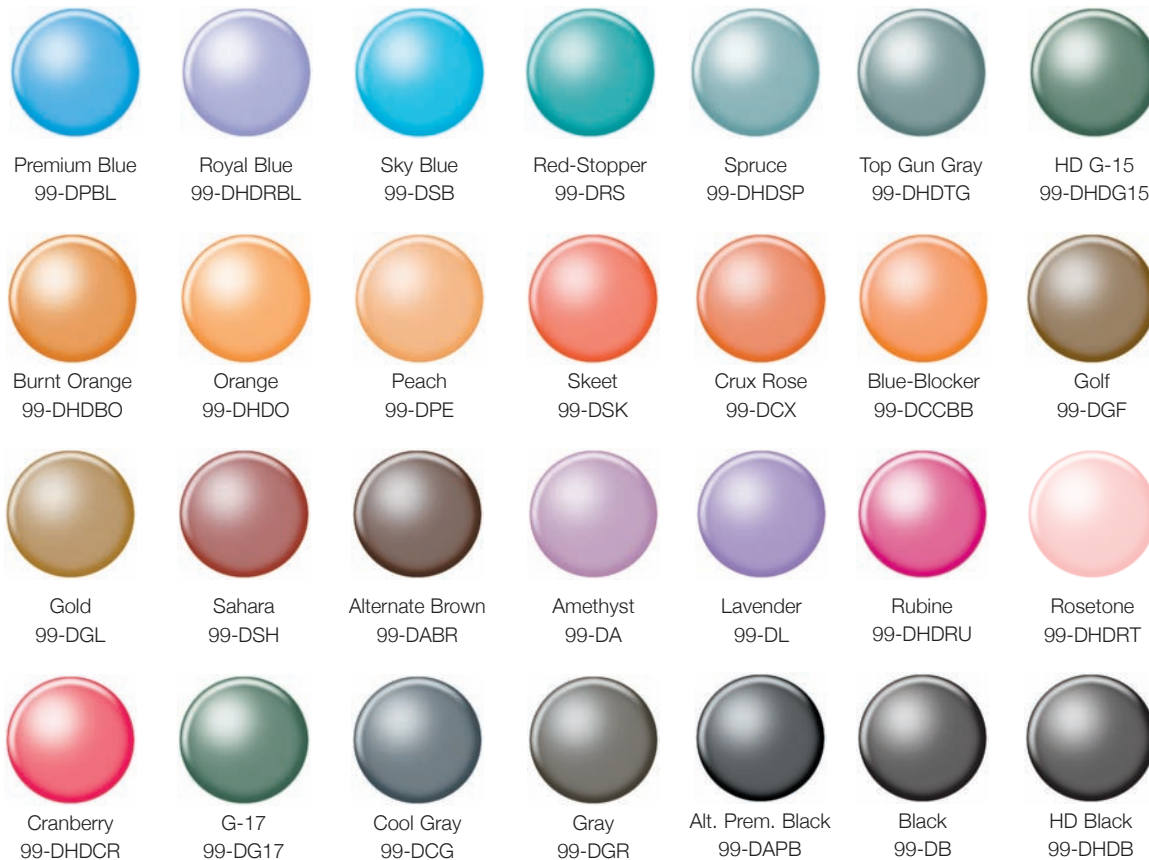



## Dry Dye Packet

\$8.99 each

Fast-dissolving dry packets replace messy bottles of dye. Simply drop a packet of dye into water and watch it dissolve into a concentrated dye bath.

- Stores easily
- No mess
- Each packet makes one quart



## UV Dyes

\$24.99 each



UV treat and tint in one simple process. The same great dye colors you have grown to love with UV protection built in. Available in select colors.

- Blocks up to 100% UV at 400 nm
- 4 oz. concentrate (makes one quart)

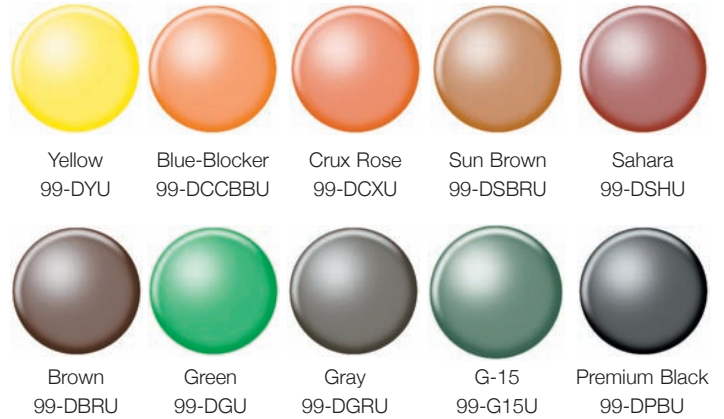

## Lens Display Book

Showcase Fashion Colors or Coatings



\*Lenses not included

- Display holds 18 lenses
- Stores easily
- Lenses are easy to remove and replace

99-OSLDB \$49.99

# PolyDye Plus

\$29.99  
each



## Finally, Tint Polycarbonate as Easily as CR-39

Our exclusive dye-stabilizing technology allows for consistent results on polycarbonate lenses. Special pH buffers allow for longer lasting, truer colors. PolyDye Plus will also work twice as fast on CR-39 and high-index materials. Available in a range of colors to satisfy all of your polycarbonate tinting needs.

- Achieve sunglass densities in just minutes on poly and seconds on plastic lenses
- Finally, true sunglass colors on polycarbonate lenses
- Safe to use on CR-39 and high-index
- Lasts longer than standard dyes
- 4 oz. concentrate (makes one quart)

## PolyDye Plus Colors



## Poly Edge Glaze

Instantly Provides Glass-Clear Edges on Polycarbonate Lenses

Poly edges are cloudy after edging, but not anymore with OptiSource Polycarbonate Edge Glaze. Instantly produces a clear, finished look on edged polycarbonate lenses. Just wipe on and let dry.



- No machinery or buffing required
- Works instantly

8 oz.	99-PEG	\$59.99
1 Pen	99-PEGP	\$29.99

## Lens Edge Pens

**\$34.99**  
each

Our Lens Edge Pens are the ideal product for finishing the edges of polarized lenses, especially on high minus work. They give a neat, finished look to the otherwise unsightly laminated edge. Our pens are also especially useful for adding a hint of color on rimless work, as well as minimizing edge thickness on lenses in full frames.



- The perfect solution to finish polarized lens edges
- Add a hint of color to rimless work
- Hides lens edge thickness in full frames

Black	99-LP-BLACK
Blue Mist	99-LP-BLUEMIST
Bordeaux	99-LP-BORDEAUX
Brown	99-LP-BROWN
Dark Brown	99-LP-DKBROWN
Fuchsia	99-LP-FUCHSIA
Gray	99-LP-GRAY
Lilac	99-LP-LILAC
Turquoise	99-LP-TURQUOISE
Violet	99-LP-VIOLET

## Latex Gloves

No other glove feels and fits like natural rubber latex. Latex offers a perfect combination of strength, tactile sensitivity, barrier protection, and comfort. This product contains rubber latex which may cause allergic reactions in some individuals.

**\$9.99**  
each



Gloves measure:  
4.8 mil palm  
8.4 mil finger  
3.6 mil cuff

- Powder-free
- Box of 100

X-Large	99-LGXL
Large	99-LGL
Small	99-LGS

## Nitrile Gloves

Nitrile gloves offer better tactile sensitivity, comfort, dexterity, and puncture resistance than both latex and vinyl. These gloves are made stronger through a manufacturing process which integrates synthetic polymers to create a multi-layered glove for enhanced protection.

**\$12.99**  
each



- Powder-free
- 5 mil thick
- Box of 100

X-Large	99-NGXL
Large	99-NGL
Small	99-NGS





## Lens Marking Pens

These fine-point pens make lens marking a cinch. Select a pen and color to suit your needs.

**\$3.99**  
each

For AR Coatings	
Red	55-319F-2
Black	55-319F-9

\*Effective on hydrophobic coatings

**\$3.49**  
each

For Non-AR Coatings	
Red	55-313-2
Black	55-313-9

## Lens Marking Ink

Lens Marking Ink leaves a sharp impression when used with lensometers, focometers or layout markers.

- Water soluble
- High visibility
- 2 oz.

**\$5.99**  
each



Yellow	99-OSMIY
Red	99-OSMIR
Blue	99-OSMIBL
Black	99-OSMIB

## Lens Marking Ink II

Our advanced ink formula resists drying-out and produces brighter markings. Lens Marking Ink II is designed for lensometers, focometers, layout markers, or any other water-soluble ink application.

- Water soluble
- High visibility
- Dispenser bottle
- 1 oz.



Red	99-260-1
Black	99-260-2
Blue	99-260-3
Yellow	99-260-4

## China Markers

These must-have grease pencils mark most lens surfaces and will remove easily. Available in five vibrant colors.

**\$2.29**  
each

Black	99-CHINABLOCK-1
Blue	99-CHINABLUE-1
Red	99-CHINARED-1
White	99-CHINAWHITE-1
Yellow	99-CHINAYLLW-1

**\$18.99**  
box of 12

Black	99-CHINABLOCK-12
Blue	99-CHINABLUE-12
Red	99-CHINARED-12
White	99-CHINAWHITE-12
Yellow	99-CHINAYLLW-12



## Ultrasonic Cleaner



Our non-ammonia formula is safe, effective and fast. Cleans parts, frames, and jewelry. Our Ultrasonic Cleaner does not produce any odors or vapors.

- Concentrated cleaner
- Works with any ultrasonic machine
- Settles particles

Gallon	99-CG	\$59.99
Quart	99-CQ	\$19.99

## Lens Prep



Lens Prep cleans and preheats the lens. The open pores on preheated lenses quickly and evenly absorb dye and UV. Can also be used cold.

- Preheats and cleans the lens
- Reduces tinting and UV treating times
- Improves tinting consistency

Gallon	99-LPG	\$59.99
Quart	99-LPQ	\$19.99

## Substitone



Substitone is the safe acetone replacement that eliminates irritating chemicals and fumes. Use it wherever you would normally use acetone.

- Safe on all lenses
- Odorless
- Quart

99-SUBQ	\$19.99
---------	---------

## Dispenser Bottle



Convenient and mess-free alternative to dispense lab chemicals.

- One-touch plastic pump
- 4 oz. glass bottle

99-DB4	\$7.99
--------	--------

## Alcohols



Add these alcohols onto your existing order to avoid frequent trips to the store.

- A lab staple conveniently delivered to your door
- Quart

Denatured Alcohol	99-DAL	\$19.99
Isopropyl Alcohol	99-IA	\$19.99

## Acetone



- Removes ink markings and cleans lenses
- Fast-evaporating
- Quart

99-AQ	\$19.99
-------	---------

## “Jimmy” Hand Cleaner and Dye Remover



“Jimmy” will quickly become your best friend in the lab. This micro-grit cream will gently clean dye stains from hands, clothes, and tint pans.

- Sold in 1 lb jar

99-J	\$24.99
------	---------



# MACHINERY

Commitment to Equipment

When it comes to the machinery necessary for finishing lenses, adjusting and cleaning eyewear, and getting diagnostic lens readings, OptiSource has a true **Commitment to Equipment**. Our machinery collection includes made-in-the-USA products, trusted European Conformity certification, and an overall focus on reliable, innovative, easy to use equipment. Look to OptiSource for the small differences that set our machinery apart from the rest.



## Digital Ultrasonic Cleaner 1,375 mL



This ultrasonic unit is a combination of the ideal size and power. This digital model includes a removable lid, bright digital display, and timer.

- Ultrasonic frequency: 42,000Hz
  - Tank material: Stainless steel SUS303
  - Tank capacity: 1,375 mL (1.45 quarts)
  - Quiet, solid state circuitry
- Power: 110V / 60W  
Weight: 4 pounds  
Dimensions (W x H x D): 7" x 6.25" x 9"

32-ULTRASNC1375 \$139.99

## Digital Ultrasonic Cleaner 600 mL



This compact unit is the right size for most frames, parts, and tools. The 600mL cleaner features digital controls and timer.

- Ultrasonic frequency: 42,000Hz
  - Tank material: Stainless steel SUS303
  - Tank capacity: 600mL (1 pint)
  - Timer: 5 cycles with digital time display
- Power: 110V / 35W  
Weight: 2.2 pounds  
Dimensions (W x H x D): 8.25" x 6" x 5.5"

32-ULTRASNCPINT \$69.99



## Stainless Steel Ultrasonic Cleaner 2,000 mL

This mini-lab sized ultrasonic cleaner is our largest and most powerful machine. The tank will fit any size eyewear. The stainless steel construction and industrial parts will provide years of quality service.

- Ultrasonic frequency: 45,000Hz
  - Tank material: Stainless steel SUS303
  - Tank capacity: 2,000 mL (2.11 quarts)
  - Quiet, solid state circuitry
- Power: 110V / 60W  
Weight: 4 pounds  
Dimensions (W x H x D): 6.25" x 7.75" x 7"

32-ULTRASNC2000 \$199.99





## 3-in-1 Lens Inspection Station

PAL Identifier, Polariscope, and Final Inspection Lamp



The Lens Inspection Station is a first-of-its-kind, three-in-one machine that includes a PAL Identifier, Final Inspection Lamp, and a Polariscope. It features an easy to use compact design and LED light sources that eliminate bulb replacement.

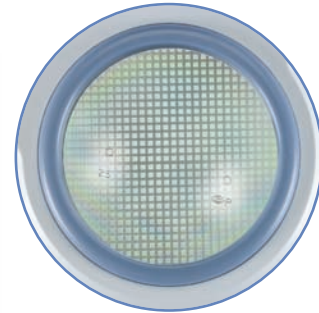

- PAL Identifier (black and white grid)
- Brings "invisible" PAL markings into focus

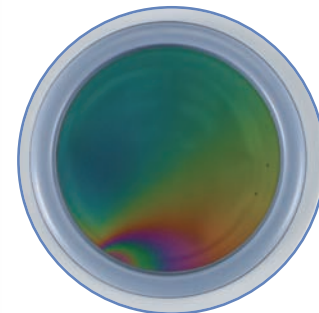

- Polariscope (gray tinted lens)
- Identifies "hidden" stress in mounted lenses and injection molded lens blanks
- Allows user to identify tempered glass lenses

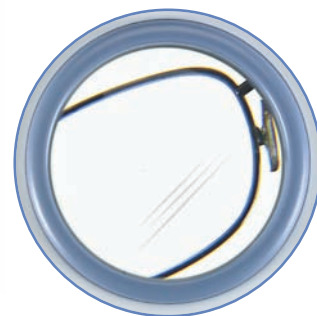

- Final Inspection Lamp (clear lens)
- White light allows user to identify any abnormalities in the finished eyewear

32-LIS

\$299.99

# All-In-One MultiMeter

UV Meter, Photochromic Demonstrator, and Visible Light Meter

OptiSource International has developed a first-of-its-kind, multifunctional digital UV meter. The single unit works as a UV Spectrophotometer, Photochromic Lens demonstrator, and Visible Light Meter. In just seconds, it will activate Transitions® or any other brand photochromic lenses. It will also measure UV transmittance of any lens and visible light transmittance of colored lenses.

The MultiMeter gives any practice the ability to demonstrate how photochromic lenses will look when exposed to sunlight without having to walk outside. Then, practitioners can show patients a digital UV reading and explain the benefits of UV blocking properties. For hard-to-match tint jobs, the MultiMeter offers a precise visible light reading to easily duplicate tint densities.

The MultiMeter's versatility makes it a must-have selling tool for any eyecare professional.



- Digital UV readings
- Activate photochromic lenses in seconds
- Great for matching tint density

Dimensions (W x H x D):  
6.75" x 6.75" x 10"  
Power: 110 Volt

99-MULTIMETER \$499.99

## Tint Pans and Lids

Two pint-size pans fit into the space of one quart-size pan to double tint capacity. Lids come with a heat-resistant knob for your safety.

- Heavy-duty, stainless steel construction
- Non-corroding
- Quart or pint size



Quart Pan and Lid  
Fits 6 3/16" x 3 1/2" opening



Pint Pan and Lid  
Fits 3 1/2" x 3 1/2" opening

Quart		
Pan	99-HDTP	\$14.99
Lid	99-HDL	\$9.99

Pint		
Pan	99-HDTPM	\$19.99
Lid	99-HDLM	\$9.99

## Lens Holders

**\$19.99**  
each

End the confusion and frustration of cross-contaminating your dye colors. Use white lens holder for UV and neutralizer solutions, and black for all of your dye colors.

- Holds lenses with a tension grip
- Compatible with gradient systems



Black 99-LH2

White 99-LHW2

# Dye-Master 9-pan Tinting System



## High-Performance, High-Production Tinting

Our latest version of the 9-pan tinting system is our smartest ever. The proprietary heating element design means that no holes are drilled below the fluid line, eliminating the possibility of leaking.

- 100% made in the USA
- High quality stainless steel
- Solid state controls

Power: 120V / 1500W  
 Weight: 28 pounds  
 Dimensions (W x H x D):  
 23" x 14" x 15"

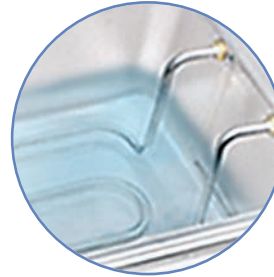
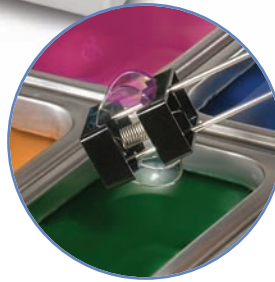

Tint unit with pans	99-TINTUNIT9	\$899.99
Base only (no pans)	99-TINTUNITB	\$799.99

## OptiSource Gradient System

Digitally controlled dipping mechanism allows for stable, non-repeating strokes that eliminates hard lines. Telescoping arm and optional weighted base allows the mechanical gradient to be used with any tint system.

- Provides smooth, no-line gradients
- Achieve soft gradients with the press of a button
- Easy-to-use dipping mechanism: set it and forget it

Power: 120V / 120W  
 Weight: 7 pounds  
 Dimensions (W x H x D):  
 6" x 18" x 7"

99-GRADIENT	\$419.99
99-GRADIENTBASE	\$49.99



\*Lens holder and weighted base not included

## Digital Hot Air Frame Warmer

We've taken our top-selling adjustable temperature frame warmer design and outfitted it with a digital controller and temperature monitor. The bright LED screen displays the actual temperature inside the housing and the latest working temperature upon restart.



Temperature range: 104°F – 302°F  
 Power: 110V / 800W  
 Weight: 3 pounds  
 Dimensions (W x H x D):  
 3.5" x 6" x 11.5"

32-WARMERDIGITL \$229.99

## Salt Pan Frame Warmer

Quickly achieves optimal temperature, yet stays cool to the touch.

- Quick heating
- Compact size
- Safe and reliable

Temperature range: Up to 400°F  
 Power: 110V / 300 Watts  
 Weight: 4 pounds  
 Dimensions (W x H x D):  
 10.5" x 4.5" x 5"

99-W2500 \$209.99



## Hot Air Frame Warmer

This warmer has a temperature knob that allows for adjustment from 130° to 230° F. Place the frame in the cup and direct heat where you need it.



Temperature range: 130°F – 230°F  
 Power: 110V / 600W  
 Weight: 3 pounds  
 Dimensions (W x H x D):  
 3.5" x 6" x 11.5"

32-WARMERSTNDRD \$199.99

## Glass Beads

These beads transmit heat evenly to the frame. Unlike salt, our glass beads will not lodge in lens grooves or frame parts.

- Useable with any Salt Pan Frame Warmer
- 5 lb containers
- Replace beads every six months for optimal performance



Small (725 micron)	99-OSSGB	\$24.99
Large (2.5mm)	99-OSLGB	\$49.99



# Axis 221 Lensmeter

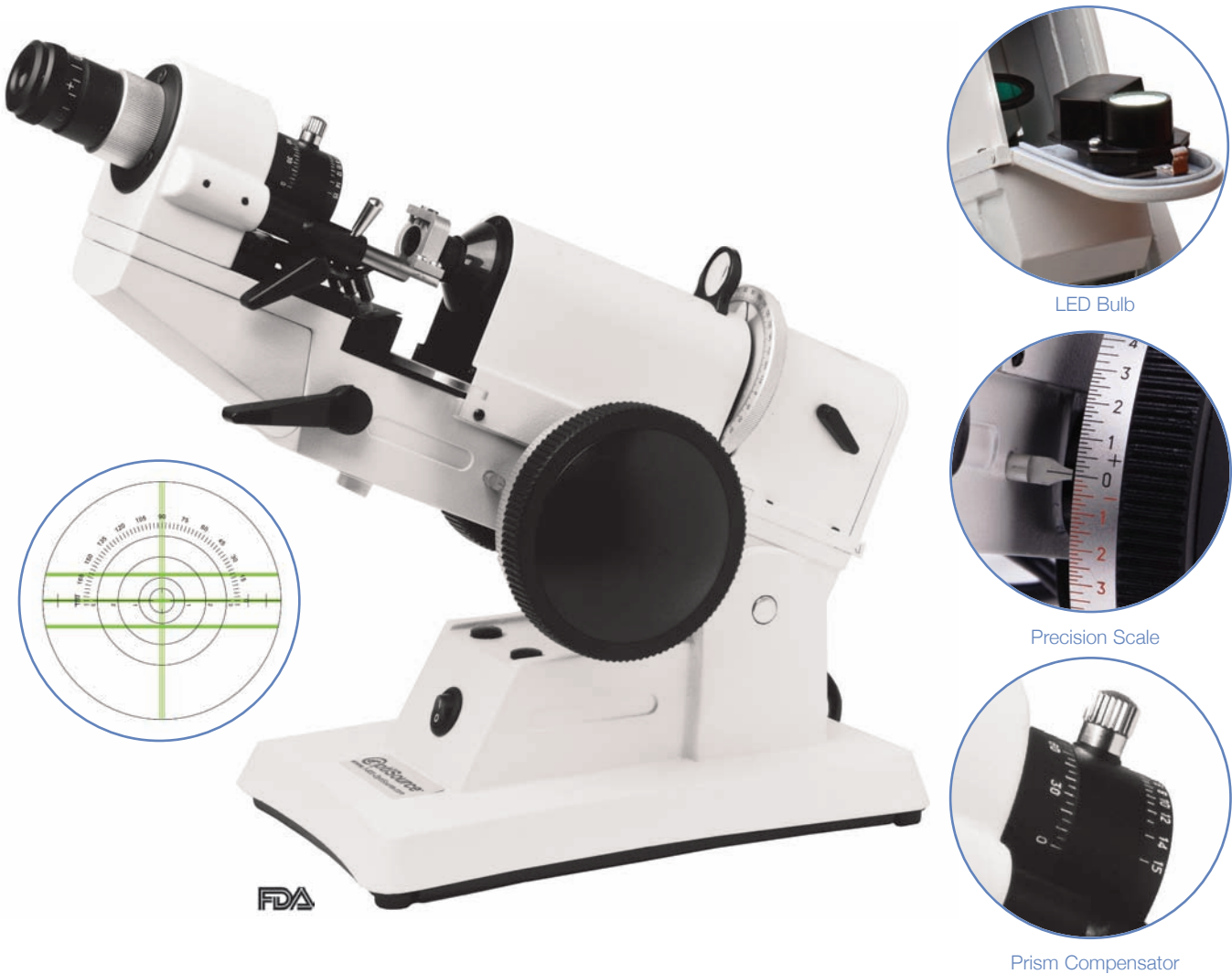

LED Bulb

Precision Scale

Prism Compensator

## Outer Reading Lensmeter

This finely crafted lensmeter is handmade to the highest standards. The Axis 221 Lensmeter uses superior quality optics, an LED light source, and includes a prism compensator in its user-friendly design. Large ergonomic knobs are clearly marked for ease of use.

### Technical specifications:

Target:	American Cross-line
Vertex Power:	Range: 0D to $\pm 20D$
Step:	0.125D up to $\pm 5D$ 0.25 at $\pm 5D$ to $\pm 20D$
Astigmatism Axis:	0 to 180°, minimum scale value 5°
Prism diopter:	1diopter intervals in the range of 0D to 20D
Prism base angle:	0 to 180°, minimum scale value 5°
Eyepiece focus:	$\pm 5D$
For lens sizes:	30mm to 90mm in diameter
Overall dimensions:	18" x 6.75" x 9.5"
Weight:	16 pounds
Lighting lamp:	LED 110V 25W equivalent

32-AXIS221      \$999.99

# Automatic Lens Groover



CE

This fully automated lens groover creates precision grooves. The grooving blade is safe for use on plastic, glass, and polycarbonate lenses. The depth of the groove is easily adjustable from 0 to 0.7mm.

- Ideal for grooving semi-rimless lenses
- Accurate, adjustable groove depth
- Adjustable groove position
- High speed 5,000 rpm motor ensures clean cutting on all materials with minimal sound
- Spare parts available: belt, blades, chucks, blocks, springs, pins, and sponges

32-GROOVERAUTO \$369.99

Replacement Parts:

Belt	32-GROOVERBELT	\$9.99
Standard Blade	32-GROOVERBLD-A	\$19.99
Premium Blade	32-GROOVERBLD-G	\$24.99
Poly Diamond Blade	32-GROOVERBLD-P	\$22.99
Spare Parts Kit	32-GROOVERPARTS	\$69.99



Universal Lens Chuck



Groove Depth



Precision Blade

Power: 110V / 90W  
 Weight: 6 pounds  
 Dimensions (W x H x D):  
 6.75" x 6" x 8.5"

Blade dimensions:  
 Diameter: 25mm  
 Thickness: 0.55mm  
 Center hole: 5mm



# Hide-a-Bevel Hand Edger



Our newest design is built to provide you with years of hassle-free use. Our Hand Edger features a diamond wheel with 3 cutting surfaces: 100 grit, 240 grit, and V-Groove.

- Large water reservoir and swarf collector
- Vibration-free operation
- Ergonomically designed
- Clear safety shield

Power: 110V / 20W  
 Weight: 33 pounds  
 Dimensions (W x H x D):  
 12.25" x 17.75" x 13"

\*To cut polycarbonate, remove the water reservoir and sponge

32-HANDEDGER	\$399.99
Replacement Wheel: 32-HNDEDGERWHEEL	\$89.99



# Automatic Lens Edge Polisher



Universal Lens Chuck



Buffing Wheel



Electronic Controls

Simply insert the lens, set the timer, and our polisher automatically rotates the lens for a high luster finish.

- Fully automatic operation
- 5 different timer settings
- Polishes all lens materials
- Includes buffing wheel and polishing compound

Power: 110V / 140W  
 Weight: 15 pounds  
 Dimensions (W x H x D):  
 8" x 9" x 12"

Replacement Buffing Wheel

Material: cloth with copper center hole  
 Diameter: 110mm  
 Width: 20mm  
 Center hole: 10mm

32-POLISHERAUTO	\$429.99
Replacement Wheel 32-POLISHWHEEL	\$14.99



See page 39 for polishing compounds



## Double Spindle Bench Polisher

This high-powered double spindle bench polisher features a sturdy design, and an easy-clean plexiglass shield. Heavy-duty rubber feet assist in vibration-free operation.

Replacement Buffing Wheel

Material: cloth  
 Diameter: 120mm  
 Width: 20mm  
 Center hole: 10mm

32-POLISHERHAND	\$239.99
Replacement Wheel 32-POLISHWHEEL2	\$14.99



# EDGING

Bright Ideas

Today's high-tech coatings, equipment, block materials, and shapes have changed the landscape of edging. OptiSource offers the most complete solution for edging lenses, especially those with premium hydrophobic anti-reflective coatings. Our selection of edge blocking pads, anti-slip discs, edger wheels, blocks, chucks, and supplies is unparalleled. As materials, coatings, and edging equipment continue to change, our **Bright Ideas** will yield products to work with them.



## 3M Leap Pads

3M Leap Pads are specially designed to meet all your edging needs. They offer superior adhesion, and they have two to three times the torque resistance of most blocking pads.



3M-1695  
24mm  
2,000 pads



3M-1696  
18mm  
1,000 pads



3M-1701  
24mm  
1,000 pads



3M-1700  
24mm  
2,000 pads



3M-1693  
18mm  
1,000 pads



3M-1712NR  
18mm  
1,000 pads



3M-1692  
26mm  
1,000 pads

## 3M Hydrophobic Pads

- Hydro specific pads
- Dual adhesive technology



3M-1707LSE  
18mm  
1,000 pads



3M-1708LSE  
24mm  
1,000 pads



3M-1712LSE  
18mm  
500 pads

08-3M1695	\$99.99
08-3M1696	\$69.99
08-3M1701	\$49.99
08-3M1700	\$89.99
08-3M1693	\$69.99
08-3M1712NR	\$79.99
08-3M1692	\$79.99

08-3M1707	\$179.99
08-3M1708	\$179.99
08-3M1712LSE	\$89.99

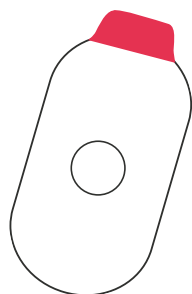

24 x 44mm

## 3M Anti-Slip Discs

For Hydrophobic Lenses

These clear film discs are 3M's solution to reduce slippage on hydrophobic coated lenses.

- 500 pads

08-3M1705	\$69.99
-----------	---------



35mm

## 3M Blue Chip Lens Protector

Protects Lenses During Edging

3M Blue Chip Lens Protector tape adheres to the center of the lens to protect against slippage and scratching from blocks and chucks. The transparent blue tape removes cleanly after use.

- 2,000 pads

08-3M1647	\$49.99
-----------	---------



# Blocking Pads

See pages 28-29 for ordering instructions



## Crimson King

The Crimson King pad material is constructed with a reinforced technology that resists high rotational forces and defies tearing. The modified acrylic adhesive bonds securely to all hard coated, standard AR coated and many hydrophobic AR coated lenses, then removes easily and cleanly.



## Cobalt King

The Cobalt King material is made from a unique high-density foam that has been used in aerospace and precision-industrial applications. The natural, rubber-based adhesive provides outstanding performance that has proven to be successful on lenses that are: hard coated, standard AR coated and (many) hydrophobic AR coated.



## Economy Blue

Economy blocking pads combine a thicker foam pad material with a basic adhesive.



## SecurEdge

SecurEdge blocking pads have a unique foam substrate and proprietary adhesive. They provide dependable torque resistance on all hard-coated and standard AR coated lenses.



# Hydrophobic Blocking Pads

## SecurEdge Plus LSE

SecurEdge Plus LSE (Low Surface Energy) pads use a "dual-adhesive" system: One side of the pad has a high-tech LSE adhesive that bonds to the Hydrophobic AR coating, while the other side of the pad firmly grips the block.



## HydroKing

Our latest innovation offers our best solution for edging hydrophobic AR coated lenses.



# Selecting and Ordering Blocking Pads

1. Select Pad Shape from Opposite Page

2. Select Material



3. Select Quantity

	Crimson King	Cobalt King	Economy Blue	SecurEdge	SecurEdge Plus	Hydro King
Roll of 1,000:	\$69.99	\$54.99	\$49.99	\$59.99	\$149.99	\$139.99
Roll of 2,000:	\$134.99	\$104.99	\$99.99	\$114.99	\$294.99	\$274.99

## How to Order

Compose the product code:

1. Use the shape number found on page 29
2. Add the material code from above
3. Add a -2 for rolls of 2,000  
(Rolls of 1,000 do not require a quantity indicator)

## Sample Product Code

Note: All product codes start with **04-**

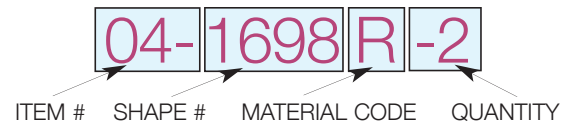

# Blocking Pad Shapes

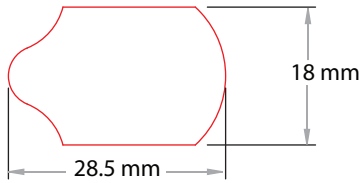

Shape: 1696NH

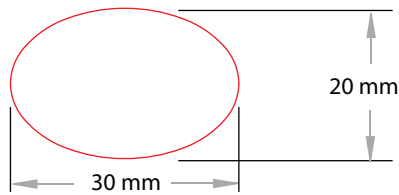

Shape: 1801

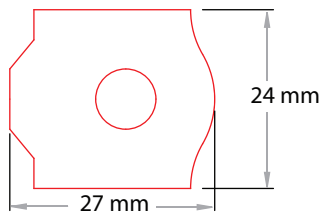

Shape: 1701

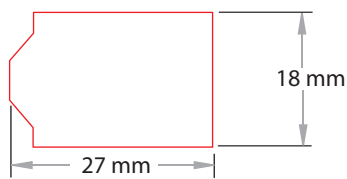

Shape: 74

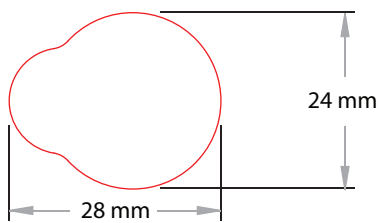

Shape: 155

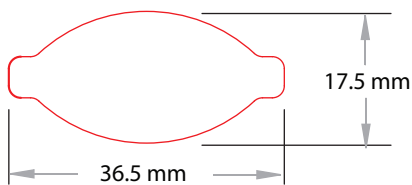

Shape: 1777

## EDGING

Shape: 1698

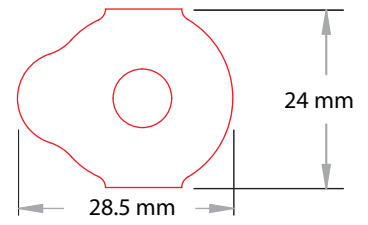

Shape: 1798

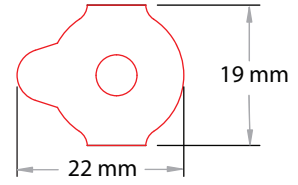

Shape: 1713

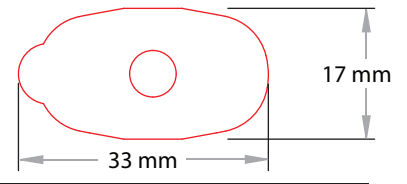

Shape: 1696

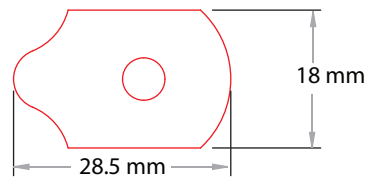

Shape: 1711

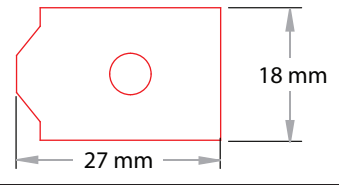

Shape: 1905

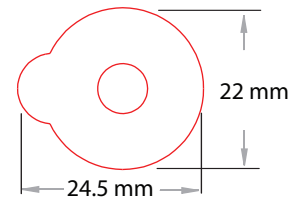

Shape: 1805

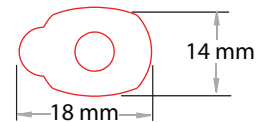

Shape: 1705

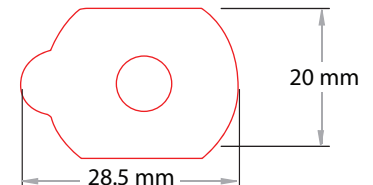

Shape: 1626

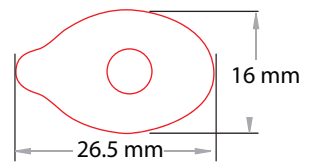



## Riki Film

The unique adhesive on the Riki Pad bonds so effectively because it was created by the makers of hydrophobic coatings. This top-performing pad adheres to all slick top coatings.

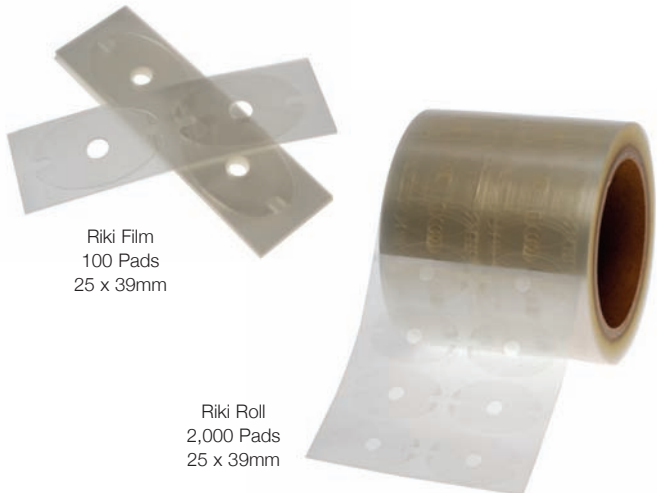

Riki Film	100	38-RIKIFILM	\$49.99
Riki Roll	2,000	38-RIKIROLL	\$679.99

## Riki 16 Blocking Pad



- Riki 16 hydrophobic blocking pad
- Converted for automatic blockers
- Combines the success of Riki pads with a premium blocking pad
- 18 x 35mm
- 1,000 pads

38-RIK16PAD	\$399.99
-------------	----------

## Standard Lens Protection Discs

Protect Your Non-Hydrophobic Coated Lenses from Scratches, Block Removal, and Chuck Pressure

- Easy-lift tab
- Clean release leaves no adhesive residue
- Rolls of 1,000

\$59.99 each



Clear Oval  
04-OLP  
19mm



Backside Chuck Pad  
04-FELTPAD  
20mm  
(Sold Only in Rolls of 500)



Clear Round  
04-CRLP  
39mm

\$39.99 each



Roll and Polish Pad  
04-70MMRPPAD  
70mm  
(Sold Only in Rolls of 500)



Blue Round  
04-BRLP  
39mm



Blue Round  
04-BTLP  
22mm



Blue Oval  
04-BOLP  
19mm

# Anti-Slip Solutions



\$199.99 each

## Intermediary Film Pads (IFP)

Our IFP offers a lower-cost alternative to the Riki Pad and features an easy-lift tab for quick removal.

- Use with OptiSource Blocking Pads to help eliminate slippage while edging hydrophobic jobs
- Features easy-lift tab
- Roll of 1,000

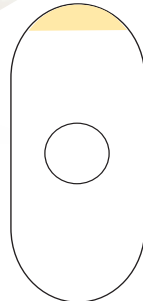

38-IFPSMALL  
18 x 40mm

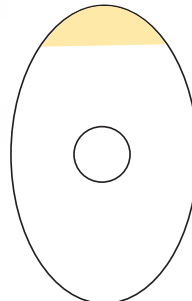

38-IFPLARGE  
28 x 40mm



## Super IFP

\$239.99 each

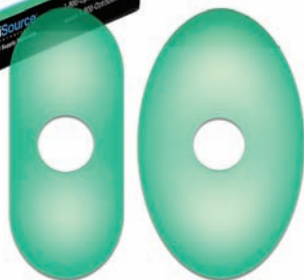

38-SIFPSMALL  
18 x 40mm

38-SIFPLARGE  
28 x 40mm

Our Super IFP has a specially formulated high-tack adhesive designed to grip to the smoothest, slickest, most oil resistant surfaces.

- Use to edge super hydrophobic and oleophobic coated lenses
- Easily removed and leaves no residue on the lens
- 1,000 pads

## Super Hydro Lens Anti-Slip Spray



Our spray-on technology is the advancement away from specialty blocking pads and lens protection discs. Simply spray it on your slickest hydrophobic coated lens, let it dry and apply any standard blocking pad.

4 oz.	99-SUPHYDRO	\$84.99
1 oz.	99-SUPHYDRO1	\$24.99



# Plastic Blocks

\$2.79 each

## Flexible and Rigid Materials

- Premium plastic compounds provide long life
  - Helps prevent crazing
  - Performs like the first time, every time
  - 25 blocks/bag
- Note: Posi blocks sold in various amounts



04-208A-25

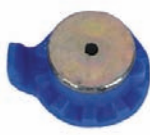

04-208B-25



04-OS94



04-OS95

## Briot Universal Block Style

25mm	04-208A-25
19mm	04-208B-25

## Essilor Gamma Style

Full Eye Rigid Plastic	04-OS94
Half-Eye Rigid Plastic	04-OS95

## Nidek Style

7000 Full Eye Rigid Plastic	04-OS70
7000 Oval Flexible Plastic	04-OS86
9000 Full Eye Rigid Plastic	04-OS92
9000 Half-Eye Rigid Plastic	04-OS93
9000 Oval Flexible Plastic	04-OSNDK

## AIT and SemiTech Style

AIT Full Eye	04-OS1678A
AIT Half-Eye	04-OS1678AH
SemiTech Full Eye	04-OS1678ST
SemiTech Half-Eye	04-OS1678STH

## Weco Style

Flexible Full Eye	28-WFB
Flexible Half-Eye	28-WFBH
Rigid Full-Eye*	28-WHB
Rigid Half Eye*	28-WHBH

\*Designed for hydrophobic AR lenses

## Posi Blocks for Profile, Alpha, Gamma, Triumph and Kappa Edgers

Essilor Profile 90/900 Flexible	14-GC4GAM072
24mm Green	14-GC4GAM202
18mm Green	14-GC4GAM203
14 x 18mm Red	14-GC4GAM216



04-OS70



04-OS86



04-OS92

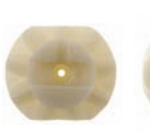

04-OS93



04-OSNDK



04-OS1678A



04-OS1678AH



04-OS1678ST



04-OS1678STH



28-WFB



28-WFBH



28-WHB



28-WHBH



Essilor Profile  
50 Blocks/Bag



24mm Green  
20 Blocks/Bag



18mm Green  
10 Blocks/Bag



14 x 18mm Red  
10 Blocks/Bag





37-1002-A

37-1002-AH-17



37-1003-BBL

37-1003-BBL-17



37-1002-B

37-1002-BH-17

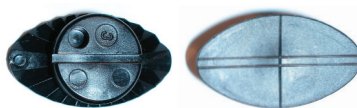

37-1007-B



37-1007-C



37-1008-B

37-1008-BH-17



37-1009-B

37-1009-BH-17



37-1010-B

37-1010-BH-17



37-1011-B

37-1011-BH-17

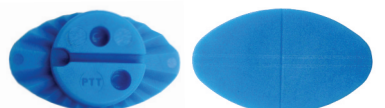

37-1014-B

### LOH Style Base-Specific

2.5 Base, Full Eye	37-1002-A	\$1.59
2.5 Base, Half Eye	37-1002-AH-17	\$1.59
3.5 Base, Full Eye	37-1003-BBL	\$1.59
3.5 Base, Half Eye	37-1003-BBL-17	\$1.59
6 Base, Full Eye	37-1002-B	\$1.59
6 Base, Half Eye	37-1002-BH-17	\$1.59

### Weco Style Base-Specific

3 Base, Oval	37-1007-B	\$1.99
5 Base, Oval	37-1007-C	\$1.99

### LOH Style Super Flex

Full Eye Flex	37-1008-B	\$1.79
Half Eye Flex	37-1008-BH-17	\$1.79
Full Eye, Solid-Back	37-1009-B	\$1.79
Half Eye, Solid-Back	37-1009-BH-17	\$1.79

### Weco Style Super Flex

Full Eye Flex	37-1010-B	\$1.79
Half Eye Flex	37-1010-BH-17	\$1.79
Full Eye, Solid-Back	37-1011-B	\$1.79
Half Eye, Solid-Back	37-1011-BH-17	\$1.79

### LOH Style Oval Flexible

Flexible Oval	37-1014-B	\$1.99
---------------	-----------	--------





## Edger Chucks

The Ideal Replacement or Retrofit Edging Chuck for Weco or LOH Style Blocks

- All chucks are made of stainless steel
- Each chuck has perfect geometry with our edging blocks
- Using "Design Fit Technology" assures precision fit
- Edging chucks fit popular edgers

For a complete product listing visit [1-800-OptiSource.com](http://1-800-OptiSource.com)

## Metal Blocks

- Half-Eye Blocks sold 5 per bag
- Full-Eye Blocks sold 10 per bag

### AIT (A-Type)

Regular Base	Low Base	High Base
--------------	----------	-----------

\$5.59  
each



08-3M1682AH



08-3M1683AH

\$2.29  
each



08-3M1678A



08-3M1682A



08-3M1683A

### SemiTech (ST-Type)

Regular Base	Low Base	High Base
--------------	----------	-----------

\$5.59  
each



08-3M1682STH



08-3M1683STH

\$2.29  
each



08-3M1678ST



08-3M1682ST

## Deblockers

### Deblocking Pliers

Remove blocks quickly and easily without damaging lenses.

- Small: 11mm diameter
- Large: 14mm diameter



\$34.99  
each

Small	34-OSTHFDEBLS
Large	34-OSTHFDEBLL

### Angled Deblocking Pliers

The angled design decreases stress for safer deblocking on AR coated lenses.



34-OSTHFDEBLANG \$34.99

### Deblocker Bar

Dual deblocking tool for:  
AIT (23 x 12mm) and  
SemiTech (22 x 16mm)

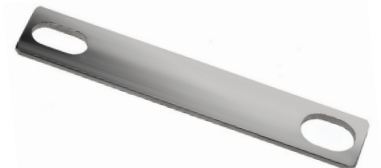

04-OS72 \$19.99

### 3M Bench-Mount Deblocker

- For deblocking of 3M metal blocks



08-3M1677U \$59.99



# Edging Wheels

Our wheels perform well in every brand and style of edger, with any lens material, and for every purpose. We carry hundreds of roughing, finishing, beveling and hand-edging wheels.

## Roughing Wheels

All of our roughing wheels for polycarbonate, plastic, and high-index are made using our proprietary brazing technology, and provide a fast and aggressive cutting action and longer life than the OEM.

## Finishing Wheels

All of our finishing wheels are made to exact OEM specifications. Special orders or special profiles can also be custom-manufactured.

## Polishing Wheels

The high luster seen after using our polishing wheels cannot be beat.

## Hand Edger Wheels

OptiSource hand edger wheels are constructed to provide accurate beveling and easy touch-up work.

## Matched Wheel Sets

Two-wheel sets include a finishing wheel and a polishing wheel with the same profile/V-Bevel. Purchasing a set will reduce downtime by requiring less calibration.

Set Consists of One Finishing Wheel and One Polishing Wheel



For a complete product listing visit [1-800-OptiSource.com](http://1-800-OptiSource.com)



## PCD Cutter Blades

Our PCD blades are made in the USA and will outlast lesser quality imported cutter blades. They are precision designed to fit your OEM equipment to provide a long cutting life.

Still using carbide cutter blades in your edger? Carbide blades will last for approximately 275 cuts and cost \$15 each (\$.055 per cut). Our PCD cutter blades will last for over 12,000 cuts and cost \$400 (\$.033 per cut), a 40% savings.

\*We also re-tip SatisLoh ES3 blades back to OEM specs. May be done up to 4 times before total replacement is necessary.



PCD Cutter Blade for Horizon	99-PCDCUTTERBLD	\$399.99
ES3/4 PCD Cutter Wheel Re-Tip	99-PCDRETIPES3	\$1,849.99

## Carbide Cutter Blades

Minimum order of 2 blades

**\$14.99**  
each



Horizon 2	99-HORIZON2
Horizon 3	99-HORIZON3
Horizon 6E	99-HORIZON6E
Horizon 7E	99-HORIZON7E

## Plastic Test Lenses



- For edger testing and calibration
- 50 lenses per box
- 70mm diameter
- 1.8mm thickness
- 6 base

99-CRTESTLENS	\$39.99
---------------	---------

## Truing Sticks

**\$4.99**  
each

Our dressing sticks bring new life to diamond wheels.

- Brown (coarse) stick quickly restores worn roughing wheels to like-new condition, reviving cutting action
- White (fine) stick dresses finishing wheels for like-new grinding



40-BTS



40-WTS

### Ask about Retruing and Sharpening Service

#### Wheels

We will bring your V-bevel back to the OEM precision standard.

#### Horizon Cutter Blades

Your carbide cutter blades can be re-sharpened 3 times! Don't discard slightly used blades. We'll make them new again. Minimum of 6 per order.

Call your customer representative today to arrange for sharpening service.

## Nu-Cool Coolant

Nu-Cool is environmentally friendly, chemically superior edger and generator coolant. Nu-Cool also eliminates foam-overs with its built-in defoamer!

- Performs well on plastic and glass
- Special detergent cleans out supply lines
- Prolongs the life of edger wheels
- Drain-safe and biodegradable
- Highly concentrated 80:1 ratio
- Performs when others fail



Gallon	99-COOL	\$69.99
Quart	99-COOLQ	\$24.99

## White Industrial Strength Defoamer

Are you having a persistent foaming problem? Our concentrated defoamer instantly knocks down any foam. Simply add to your edger or generator reservoir and watch your foam disappear.

- Stops foam in its tracks and prevents foam-overs
- Extremely concentrated: 1 capful defoams 5 gallons
- Water-soluble and biodegradable



Gallon	99-DFG	\$69.99
Quart	99-DFQ	\$29.99

## Little Giant Submersible Pumps

These Little Giant pumps may be used totally submersed or in-line (fed with pipe or hose). They are constructed of epoxy-coated die-cast aluminum, and the motors are oil-filled.

- Heavy duty pumps for water or coolant systems
- Epoxy-coated aluminum housing
- 6' cord
- Three models in stock and ready to ship
- Heavy-duty construction provides long life



SPECS: 2E-38N	SPECS: 3E-12N	SPECS: 4E-34NR
100 watts	200 watts	210 watts
3/8" FNPT intake	1/2" FNPT intake	3/4" FNPT intake
1/4" MNPT discharge	1/2" MNPT discharge	1/2" MNPT discharge
1/40 HP motor	1/15 HP motor	1/12 HP motor
11.8' max. lift	17.3' max. lift	24.5' max. lift

1/40HP 5.1PSI	99-LGP-2E-38N	\$99.99
1/15HP 7.5PSI	99-LGP-3E-12N	\$149.99
1/12HP 10.6PSI	99-LGP-4E-34NR	\$219.99

## Pink Industrial Strength Defoamer

Persistent foaming problem? Simply add a few drops of our Pink Defoamer to your edger or generator reservoir and watch your foam disappear.

- Highly concentrated: 1 capful defoams up to 5 gallons of liquid
- Fully water-soluble
- Biodegradable



Gallon	99-PDFG	\$69.99
Quart	99-PDFQ	\$29.99

## Non-Silicone Defoamer

Our super-concentrated non-silicone defoamer is effective at knocking down foam in all recirculating processing systems. The absence of silicone aids in the acceptance of coatings.

- Super-concentrated
- 8 oz.



99-NSDF8	\$24.99
----------	---------

# Buffing Pads

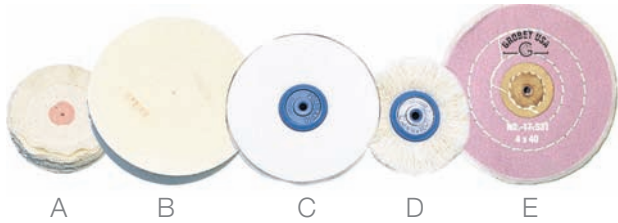

## Dixcel Flannel Buffs

### A Cotton Flannel

Soft cotton flannel produces a high polish when used with rouge. Well-stitched with shellac centers.

Dia.	Ply	Code	Price
3"	30	03-17.203	\$6.99
4"	30	03-17.205	\$7.99
5"	30	03-17.206	\$9.99
6"	30	03-17.207	\$10.99

## Felt Buff

### B Solid Felt

Highest quality wool felt, carefully compressed and formed for uniform texture, hardness and shape. Ideal for the first step of lens edge polishing.

Dia.	Ply	Code	Price
3"	1/2"	03-17.429	\$11.99
3"	Knife Edge	03-17.498	\$12.99
3"	1"	03-17.431	\$16.99
4"	3/4"	03-17.436	\$20.99
4"	1"	03-17.437	\$24.99
5"	2"	03-17.438	\$58.99
6"	1"	03-17.439	\$46.99
6"	1/4" Ctr hole 3/4"	03-17.440	\$14.99

### C Fine Soft Felt

6-ply with plastic center. A delicate touch and white rouge can remove hairline scratches from lenses before coating. High gloss final lens edge polishing with white rouge.

Dia.	Ply	Code	Price
3-1/2"	1/2"	03-17.130	\$14.99

## Yarn Buff

### D Woven Yarn

Light touch for final polish. Produces extra high gloss on lens edges, especially polycarbonate, high-index and CR-39. Strands of cotton yarn are woven into a solid plastic center. Will not fray or burn lens edges.

Dia.	Ply	Code	Price
3-1/2"	3/4"	03-17.213	\$14.99

## Berry Buff

### E Muslin

Stiff chemically treated fine-weave muslin. Good for polycarbonate and high-index edge polishing.

Dia.	Ply	Code	Price
4"	40	03-17.531	\$10.99



## Muslin Buffs

### F Dixcel Unbleached Muslin

Coarse, unbleached muslin. For cutting and preparing metals for fine finish. With three rows of stitching.

Dia.	Ply	Code	Price
3"	35	03-17.577	\$6.99
4"	42	03-17.581	\$5.99
6"	50	03-17.588	\$9.99

### G Super Buff

100% cotton, specially treated to make the cloth finer and virtually lint-free. Lasts up to 50% longer. With 4 rows and shellac centers.

Dia.	Ply	Code	Price
3"	50	03-17.704	\$9.99
4"	60	03-17.706	\$15.99

### H Dixcel Extra Fine

Fine, high-grade muslin with combed edges and hardened shellac centers.

Dia.	Ply	Code	Price
3"	35	03-17.622	\$6.99
4"	50	03-17.624	\$7.99
5"	55	03-17.625	\$10.99

### I Dixcel Yellow "Treated"

Chemically treated, coarse, unbleached high-grade muslin with combed edges to resist fuzzing. Shellac centers.

Dia.	Ply	Code	Price
4"	40	03-17.553	\$6.99
5"	45	03-17.554	\$6.99
6"	50	03-17.555	\$9.99

### J Dixcel Plastic Centers

Loose, unstitched, fine-grade muslin. Use with rouge for a high luster finish.

Dia.	Ply	Code	Price
4"	36	03-17.719	\$7.99
5"	54	03-17.721	\$9.99

### K Dixcel Leather Centers

Fine-grade muslin, loosely sewn, with leather centers to provide a firm grip on spindles.

Dia.	Ply	Code	Price
5"	45	03-17.755	\$8.99
5"	50	03-17.759	\$8.99
6"	50	03-17.756	\$10.99



## Pattern Blanks

\$29.99  
per bag

Our universal Pattern Blanks are the easiest patterns you'll ever work with. They incorporate raised grids on one side and engraved grids on the other. The semi-rigid material makes for efficient cutting on any brand of machinery, or by hand.



Beige  
99-PB

White  
99-PBW

- Medium thickness (80 x 60mm)
- Easy to cut
- Easy to read
- Embossed lines
- 100 per bag

## Jumbo Green Pattern Blanks

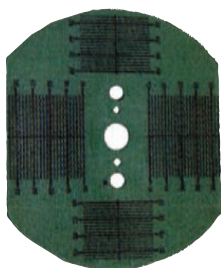

Green  
03-83.107

Our Jumbo Green Pattern Blanks are easy to cut, and the embossed measuring lines allow for easy size-matching.

- Smooth-cutting rigid plastic is 1/16" thick with reinforcing hub
- Good for use in automatic pattern makers
- 80 x 65mm
- 50 per bag

## "Big Stick" Polish Rouge

Our polishing compounds work for all lens materials. Use edge polish sticks to rapidly buff lens edges to a high luster. Huge 1 lb. bar.



CR-39 Polish Stick	71-BX-7057
Poly Polish Stick	71-BX-7058
High-Index Polish Stick	71-BX-7059

\$24.99  
each

## Polishing Compounds



This economical and safe container keeps your hands clean and can be used to the last particle.

- White:** Final high gloss finish polishing compound for all plastic lens edges.
- Red:** Edge polish for glass lenses and metal frames. Water soluble.
- Yellow:** High gloss polishing compound for all plastic lens edges. Useful for index lenses.
- Blue:** First step compound favored by many for index materials. Use with solid felt buff and follow with finish compound for excellent results.
- Zam Green:** First step compound for all plastic lens edges. Good choice for index materials. Follow with finish compound.
- Wonder Bar:** Final step polish for use on both metals and plastics.
- Green:** First step compound for all plastic lens edges. Use with solid felt buff and follow with finish compound.
- Crystal Kleer:** Excellent finish polish for clear and colored plastics of all types. Especially useful for ZYL.

White Rouge 5 oz.	03-47.326	\$6.00
Red Rouge 6 oz.	03-47.324	\$6.00
Yellow Rouge 5 oz.	03-47.327	\$6.00
Blue Rouge 4 oz.	03-47.322	\$6.00
Zam® (Green) 1lb. 2 oz.	03-47.503	\$10.00
Wonder Bar 4 oz.	03-47.328	\$5.00
Green Rouge 5 oz.	03-47.321	\$6.00
Crystal Kleer 6 oz.	03-47.310	\$7.00



Custom Bottle. Custom Color. Custom Label.



Customize and Order Online

[www.1-800-OptiSource.com/Custom-Clean](http://www.1-800-OptiSource.com/Custom-Clean)





# SURFACING

Flower Power

Our diverse surfacing supplies collection includes the essential necessities for both traditional lens processing as well as today's digital needs. Our best-selling surfacing pads are produced from the highest-quality, most trusted materials from around the globe to give you the best Flower Power for your fining and polishing operations. Our backside coating, high purity alloy, polishes, and surface protection tapes have all been carefully formulated and selected to provide you with the most reliable surfacing consumables available.



## Digital Polish Tools For Schneider Equipment

\$9.99  
each



Our tools feature a thick, flexible pad surface that resists tearing and increases usable life. The flexible design maximizes surface conformity, ensuring the highest quality freeform finish.

- Available in 3 color-coded bases: 075, 150, and 600
- One Step polishing cycle for all organic lenses eliminates the need for a second stage flock polishing pad
- Top surface holes help increase polish flow



First stage / One step - Pink		Second stage - Black	
R75	89-PT-S4-0075	075	89-PT-S4-0075B
R150	89-PT-S4-0150	150	89-PT-S4-0150B
R600	89-PT-S4-0600	600	89-PT-S4-0600B

## Alloy



- Available in 117° F melting point
- Works in all alloy blocking machines
- 1 lb. bar

\* Call for assistance with other melting points.

23-A117-1LB Call for pricing

## Finished Job Cases



WHOLESALE LABS: Are you still using foam sheets and rubber bands to return finished work to your customers? Our environmentally friendly, recyclable, reusable job case is a quantum leap in delivering jobs to your valuable customers. Our PET recyclable plastic case is rigid for better protection, clear for instant identification, and can be reused more than twelve times.

- Custom colors and imprinting available
- “Green” alternative to Styrofoam or plastic bags
- Professional presentation
- Sold 1,000 per case

99-LABCASECLEAR Each \$.28



Small Tray  
6" wide x 9" long x 1.5" deep

\$2.79  
each

## Small Job Trays

Self-nesting partitioned job tray comes with an adjustable divider.

- Available in eleven different colors
- Self-stacking
- Sold 24 per case (1 color per case)

	BLACK	BLUE	BROWN	GREEN	GRAY	IVORY	ORANGE	PINK	PURPLE	RED	YELLOW
Small:	69-101	69-102	69-103	69-104	69-105	69-106	69-107	69-108	69-109	69-110	69-111
Large:	69-201	69-202	69-203	69-204	69-205	69-206	69-207	69-208	69-209	69-210	69-211



Large Tray  
7" wide x 12" long x 2" deep

\$4.99  
each

## Large Job Trays

Dual partition separates left and right lenses, and lenses from frames. Rigid plastic offers reliable stacking, no warping, and a long life.

## Job Tray Cleaner

Our innovative solution is the only formula proven to thoroughly clean dried polish from all job trays. Restores job trays to like-new condition.

- Simple spread on, wipe off process
- Helps eliminate scratched lenses
- Quart



99-278-1 \$19.99

# Spin-On UV-Hardcoat

UV Curable Backside Spin Coating

Spin-On delivers guaranteed superior performance at a significant savings. Its solvent-free formula is both safe and effective.

- Compatible in all standard spin coater machines
- Superior scratch resistance and tintability
- Excellent adhesion to AR
- 4 oz.



## Conversion Kit

- One 5 micron coating filter
- One pair of gloves and safety goggles
- Two empty 4 oz. bottles
- Four feet of tubing for coating station
- One gallon size zip bag

99-SPINONCK \$79.95

99-SPINON \$399.99

## Cylinder Machine Reception Chucks

\$199.99 each

Our replacement reception chucks fit all Satisloh® conventional cylinder machines. Made of a proprietary plastic, they offer extended longevity.

- Sold by the individual chuck

### Loh Block Style

Left	91-ZELRCPL-LEFT
Right	91-ZELRCPL-RIGHT

### Gerber Block Style

Left	91-ZELGRCLPL
Right	91-ZELGRCRPL



Loh Block Style



Gerber Block Style



# Surfacing Pads - Shape Guide

As well as the traditional 6- and 7-petal surfacing pads, we offer a range of alternative pad shapes for different applications, such as high curve impellor pads.



**Q** 8 Leaf  
3"  
3.25"  
3.5"



**T** 7 Leaf  
3"  
3.125"  
3.25"  
3.5"



**P** 6 Leaf  
2.65"  
3"  
3.125"  
3.25"  
3.5"



All surface pad items and pricing refer to 76mm (3") 7-Leaf shape.

All other shapes and sizes are available upon request.



## “Superfine” Black 1st Fine

A unique 1st fine pad, it gives consistent and high stock removal rates throughout the fining cycle, yet achieves an excellent surface finish for the 2nd fine stage. The flexible backing ensures excellent conformity to the tool.

MATERIAL:	Silicone Carbide			
THICKNESS:	0.27mm	500/Roll	89-A1D2N	\$49.14
SIZES:	All sizes			
SHAPES:	P,Q,T			



## Hi-Index 1st Fine

The Black 1st fine Hi-Index pad is an evolutionary pad designed for use with modern generators with little or no elliptical error. The lower stock removal rates make it ideal for today's soft Hi-Index lens material.

MATERIAL:	Silicon Carbide			
THICKNESS:	0.28mm	500/Roll	89-A2D2N	\$57.02
SIZES:	All sizes			
SHAPES:	P, Q, T			



## “Superfine” Black 2nd Fine

Superfine is a more aggressive addition to our family of 2nd fine pads with increased stock removal rates. Consistent results ensure complete suitability on the full range of CR-39 and Hi-Index lens material. The specially formulated backing allows excellent conformity to the tool when placed directly over the 1st fine pad.

MATERIAL:	Silicon Carbide			
THICKNESS:	0.26mm	500/Roll	89-C1D2N	\$68.64
SIZES:	All sizes			
SHAPES:	P, Q, T			



## “Superfine” Pink 2nd Fine

This pad has been designed especially for use with the latest generation of processing equipment and plastic lens materials. The aluminum oxide abrasive is unique and requires no breakdown of the abrasive to achieve a high quality surface with minimum running times. For the best results, use a direct water supply running to waste.

MATERIAL:	Aluminum Oxide			
THICKNESS:	0.13mm	500/Roll	89-C2D2N	\$62.82
SIZES:	All sizes			
SHAPES:	P, T			



## 180 Grit Roughing

The 180 grit is a well tried extremely aggressive pad and is ideally suited for curve correction or removal of extreme elliptical error.

MATERIAL:	Aluminum Oxide			
THICKNESS:	0.40mm	500/Roll	89-B1D2N	\$35.08
SIZES:	76mm, 89mm			
SHAPES:	P, T			

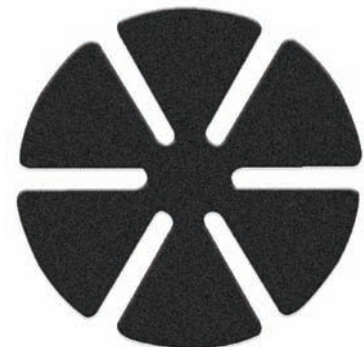



## Red 1 Step

The unique design and specification of the aluminum oxide particles ensures a high, consistent stock removal rate throughout the curve range and in all conditions while maintaining an excellent surface quality. Available with the special compensated backing which is the thickness of a 1st and 2nd fine pad combined, or as a non-compensated version.

MATERIAL:	Aluminum Oxide			
THICKNESS:	0.27mm, 0.47mm compensated	500/Roll	89-D1D2C	\$43.38
SIZES:	All sizes			
SHAPES:	P, Q, T			



## Black 1 Step

The surface structure of the pad is designed to give excellent stock removal characteristics while maintaining a quality lens surface without extending polishing times. Available as a standard thickness or with the special compensated backing which is the thickness of a 1st and 2nd fine pad.

MATERIAL:	Silicon Carbide			
THICKNESS:	0.27mm, 0.47mm compensated	500/Roll	89-E1D2C	\$40.66
SIZES:	All sizes			
SHAPES:	P, Q, T			



## Quantum 1 Step

This special abrasive is unique, giving the highest quality surface with minimum running times and providing an excellent foundation for AR coating. It is available with the special compensated backing or in the non-compensated version.

MATERIAL:	Aluminum Oxide			
THICKNESS:	0.27mm, 0.47mm compensated	500/Roll	89-D3D2C	\$37.46
SIZES:	All sizes			
SHAPES:	P, Q, T			



## Claris 1 Step

Developed to achieve exceptional one-step surface quality on CR-39, Hi-Index, Spectrolite, and photochromic lens materials. The ultra-fine surface quality has been brought about by careful selection of the grit particle size and a new bonding process. Claris will give excellent surface quality on all of today's modern surfacing equipment.

MATERIAL:	Aluminum Oxide			
THICKNESS:	0.27mm, 0.47mm compensated	500/Roll	89-D4D2C	\$35.36
SIZES:	All sizes			
SHAPES:	P, Q, T			



## 320 Grit Roughing

An aggressive Silicon Carbide material specifically designed as a superior first fine pad for polycarbonate lenses. It gives a consistent removal rate throughout the fining operation and leaves a regular surface for the next fining stage. This pad can also be used as a standard roughing pad for CR-39 and Hi-Index lenses with excellent results.

MATERIAL:	Silicon Carbide			
THICKNESS:	0.40mm	500/Roll	89-B2D2N	\$55.48
SIZES:	76mm, 89mm			
SHAPES:	P, T			

## Black Polycarbonate 1 Step

The Black Polycarbonate 1 Step has been developed for the discerning customer who is looking for minimal stock removal while achieving the best possible finish quality on Polycarbonate and Trivex® lenses. It is produced to exceptionally high standards by selecting the finest grade abrasive grit and materials to produce the best finished result possible.

MATERIAL:	Silicon Carbide			
THICKNESS:	0.46mm compensated	500/Roll	89-E1D2C	\$40.66
SIZES:	76mm, 89mm			
SHAPES:	P, T			



## Next Polycarbonate 1 Step

Next Polycarbonate 1 Step represents the next generation in polycarbonate finishing pads. The high quality surface that can be achieved is possible due to the constant search for new manufacturing processes, material selection, strict quality control, careful selection of the grit particle size, and a new bonding system.

MATERIAL:	Aluminum Oxide			
THICKNESS:	0.27mm, 0.46mm compensated	500/Roll	89-E2D2C	\$36.34
SIZES:	76mm, 89mm			
SHAPES:	P, T			



## Merlin 1 Step Multiplex

The Merlin Multiplex pad is a natural progression from our original Wizard Pad, which was the first multipurpose one step pad to be developed for finishing both polycarbonate and CR-39 materials. This one step pad does away with the multitude of pads found in most labs, eliminating the need to have different pads for different plastic lens materials.

MATERIAL:	Silicon Carbide			
THICKNESS:	0.27mm, 0.46mm compensated	500/Roll	89-F1D2C	\$35.00
SIZES:	76mm, 89mm			
SHAPES:	P, T			



## Q 1 Step Multiplex

Q Multiplex pad allows the customer all the freedom of having only one pad in stock for handling all lens types, from simple CR-39 to polycarbonate and beyond.

MATERIAL:	Aluminum Oxide			
THICKNESS:	0.27mm, 0.46mm compensated	500/Roll	89-F2D2C	\$41.26
SIZES:	76mm, 89mm			
SHAPES:	P, T			



## White Polishing

This addition to our range of polishing pads was developed to be compatible with all lens materials, liquid polishes, and makes of machinery. Its balance between performance and cost makes this product the top choice for a great number of customers who are looking for exceptional value and good, consistent quality.

MATERIAL:	Short flock synthetic			
THICKNESS:	0.75mm (compressed)	250/Roll	89-G1D2	\$25.16
SIZES:	All sizes			
SHAPES:	P, Q, T			







## Yellow Lustre Polishing

Yellow Lustre is the original benchmark for companies looking to buy the best possible high-end polishing pad on the market. The cotton twill backing and the uniform nap length give a firm pad with excellent curve reproduction capabilities. The Lustre is particularly suited for use after one-step fining and cut-to-polish operations on both CR-39 and Hi-Index lenses.

MATERIAL: Short flock synthetic  
THICKNESS: 0.70mm (compressed)  
SIZES: All sizes  
SHAPES: P, Q, T

250/Roll	89-G3D2	\$26.90
----------	---------	---------

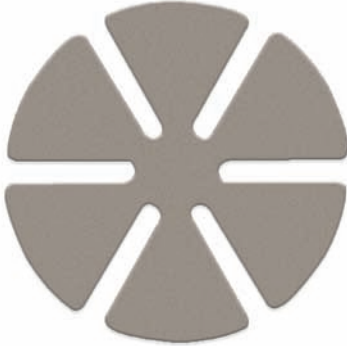

## Silver Polishing

The Silver Polishing pad is ideal for the customer looking for the balance between economy and quality. This polishing pad has specifically been developed for all types of machines and lens materials. The synthetic substrate backing and uniform velveteen nap give a firm pad with excellent curve reproduction capabilities.

MATERIAL: Short flock synthetic  
THICKNESS: 0.70mm (compressed)  
SIZES: All sizes  
SHAPES: P, Q, T

250/Roll	89-G4D2	\$30.52
----------	---------	---------



## Sapphire Polishing

Sapphire's short synthetic nap allows for the maximum delivery of polish to the lens surface ensuring superb results. It also benefits from our unique backing and adhesive technology, making it suitable for use on all lap types, while absorbing any minor defects in the surface of the tool.

MATERIAL: Short flock synthetic  
THICKNESS: 0.70mm (compressed)  
SIZES: All sizes  
SHAPES: P, Q, T

250/Roll	89-G5D2DC	\$28.32
----------	-----------	---------



## Performa Polishing

The Performa is a high performance plastic polishing pad which has been specially developed for today's demanding production and to complement the latest advancement in aluminum oxide organic lens polishes.

MATERIAL: Short flock synthetic  
THICKNESS: 0.70mm (compressed)  
SIZES: All sizes  
SHAPES: P, Q, T

250/Roll	89-G2D2	\$26.38
----------	---------	---------



## Rose Polishing

The Rose pad incorporates new unique flock length technology. The nap on this pad is very soft and flexible and not of a uniform length. It allows a far greater flow of polish to the surface of the lens and pad, dramatically increasing the amount of polish at the lens surface during the polish cycle. Rose is suitable for use with all types of lens materials and machinery but is especially suited for labs that run a high percentage of Hi-Index, polycarbonate, Trivex<sup>®</sup>, and AR coated lenses. It provides outstanding results when run on the latest cut-to-polish equipment.

MATERIAL: Short flock synthetic  
THICKNESS: 0.85mm (compressed)  
SIZES: All sizes  
SHAPES: P, Q, T

250/Roll	89-G7D2	\$34.06
----------	---------	---------

# Tape Dispenser System

Designed and tested to apply surface saver tape uniformly across ophthalmic lens surfaces by using air pressure.

- Eliminates manual application
- No electrical connection
- Requires 60 psi

08-3M1645 \$2,839.99



## Surface Saver Blades



- Sold in packs of 5

08-3M9944 \$79.99

## 3M Surface Saver Knife Blade Handle



- For use with 3M Surface Saver knife blades

08-3M9942 \$14.99

## 3M Clear Surface Tape



- Linerless clear tape for wax blocking
- 4" x 72 yards

08-3M1663 \$64.99

## 3M Surface Saver II Tape

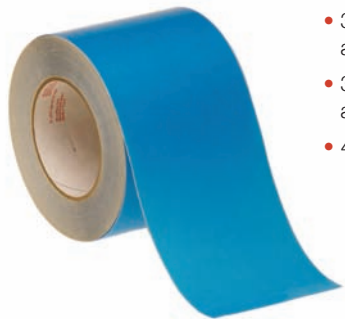

- 3M1641 for medium-temperature alloy blocking
- 3M1640 for high-temperature alloy blocking
- 4" x 36 yards

3M1641 08-3M1641 \$34.99  
 3M1640 08-3M1640 \$34.99

## Ceri-Guard 600 Linerless Surface Tape

This premium linerless surface tape is specially formulated to give extra heat reflection and surface protection while conforming to all lens surfaces including deep curves, lenses, and executives.

- Available in blue and green
- 4" x 76.5 yards  
Double the Length

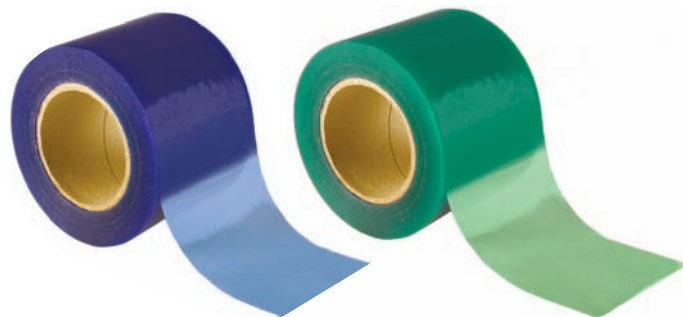

Blue 99-SSTLINERLESS \$69.99  
 Green 99-SSTGLINERLESS \$69.99

## Clear Surface Tape



- Economical tape for wax blocking systems
- Clear tape makes for easy layout
- 4" x 36 yards

51-SSTC \$29.99

## Premium Surface Protection Tape

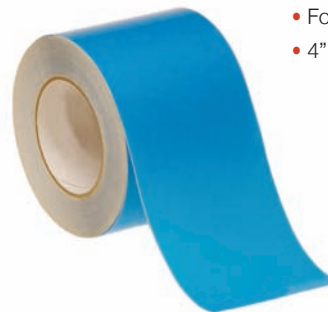

- For plastic lens applications
- 4" x 36 yards

51-SST \$29.99

## Economy Surface Protection Tape

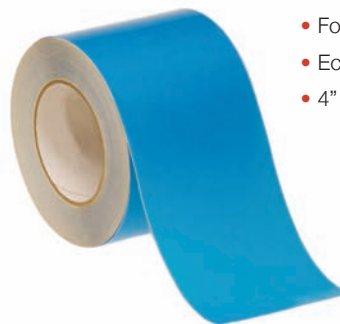

- For plastic lens applications
- Economically priced
- 4" x 36 yards

89-SST2 \$27.99



# Chem Tempering Salts

\$59.99 each

- Produces a compressive stress in the lens surface
- Designed to work with any chem tempering equipment
- 10 lb. container



2-Hour Photochromic  
27-PHOTO2

16-Hour Photochromic  
27-PHOTO16

16-Hour Crown  
27-CROWN16

## Plastic Fiberlite Laps

\$7.99 each

High-quality plastic laps will not warp over time. They do not produce dangerous fumes or odors when cut and allow for faster machining.

- Can be cut on most 3-axis generators
- Engineered for superior curves and workmanship

Plano	06-DV-MAPSF
2-Base	06-DV-MA2SF
4-Base	06-DV-MA4SF
6-Base	06-DV-MA6SF
8-Base	06-DV-MA8SF
10-Base	06-DV-MA10SF



Plano



6-Base Semi-Finished



2-Base Semi-Finished



8-Base Semi-Finished



4-Base Semi-Finished



10-Base Semi-Finished

# Premium Lens Polish

\$39.99  
each



50-CPP

## Clarity Plus

- 1.1 micron particle size
- 23° Baume
- Best for polycarbonate polishing
- Gallon



50-HA1

## HA-1

- 2.0 micron particle size
- 24° Baume
- Universal formula is simple to use
- Gallon



50-V2100

## V2100

- 2.2 micron particle size
- 23 - 25° Baume
- Less aggressive stock removal
- Gallon



## Americal Plus

- Rapidly removes stock on all lenses, regardless of curvature
- Excellent for hard resin, polycarbonate, and high-index lenses
- Ideal for AR and hard coatings
- 1.2 - 1.7 micron particle size
- 25 - 30° Baume
- Gallon

99-AMERICALPOL \$39.99



## Polish All

- 1.7 micron particle size
- 23 - 25° Baume
- Econo-formula
- Gallon



50-PA \$29.99

# Ball Cutters



3-Flute	99-3FLUTECUT	\$94.99
6-Flute	99-6FLUTECUT	\$94.99
9-Flute	99-9FLUTECUT	\$104.99
11-Flute	99-11FLUTECUT	\$94.99
12-Flute	99-12FLUTECUT	\$94.99
Ball Cutter Sharpening	99-BALLCUTRETR	\$49.99

We can resharpen your ball cutters until they reach 18.2mm in diameter. Don't throw away your slightly used ball cutters! They can be resharpened up to 6 times.

# Generator Wheels

Manufactured to OEM Specifications

The diamond grit size, bond, and concentration are specifically selected for maximum performance and life. Concentricity is held to precise tolerances to ensure smooth operation.



See our full listing of generator wheels online

# Diamond Tooling

Our PCD tools are 100% made in the USA and will outlast lesser quality imported cutting tools. They are precision designed to fit your OEM equipment and provide a long cutting life.



## PCD Generator Blades / Milling Inserts

Coburn IQ	99-PCDBLADEIQ	\$159.99
LOH V-Pro Series (set of 8)	99-PCDBLADEPROV	\$1,449.99
Coburn DTL	99-PCDBLADEDTL	\$499.99
Schneider 8-Tooth Milling Tool Retip	99-SCHNEIDER8RT	\$1,399.99
Schneider 12-Tooth Milling Tool Retip	99-SCHNEIDER12RT	\$1,599.99
Satisloh 12-Tooth Milling Head Retip	99-PCDLOH12RT	\$899.99

## PCD Ball Mill Cutting Tools

- Fits 2G and Vista Generators

PCD Ball Mill Cutter	99-PCDBALLMILL	\$849.99
Retrue Ball Mill Cutter	99-PCDRETRUE2FL	\$449.99

## Single Crystal Diamond Cutter

- 2mm natural diamond

Schneider Generators	99-PCDDIAMOND1	\$579.99
LOH VFT Generators	99-PCDDIAMOND2	\$999.99

Are you using a new model generator? Is your equipment not listed here? Just give us a call for a prompt quote. We can retrue your worn cutters back to OEM specs.



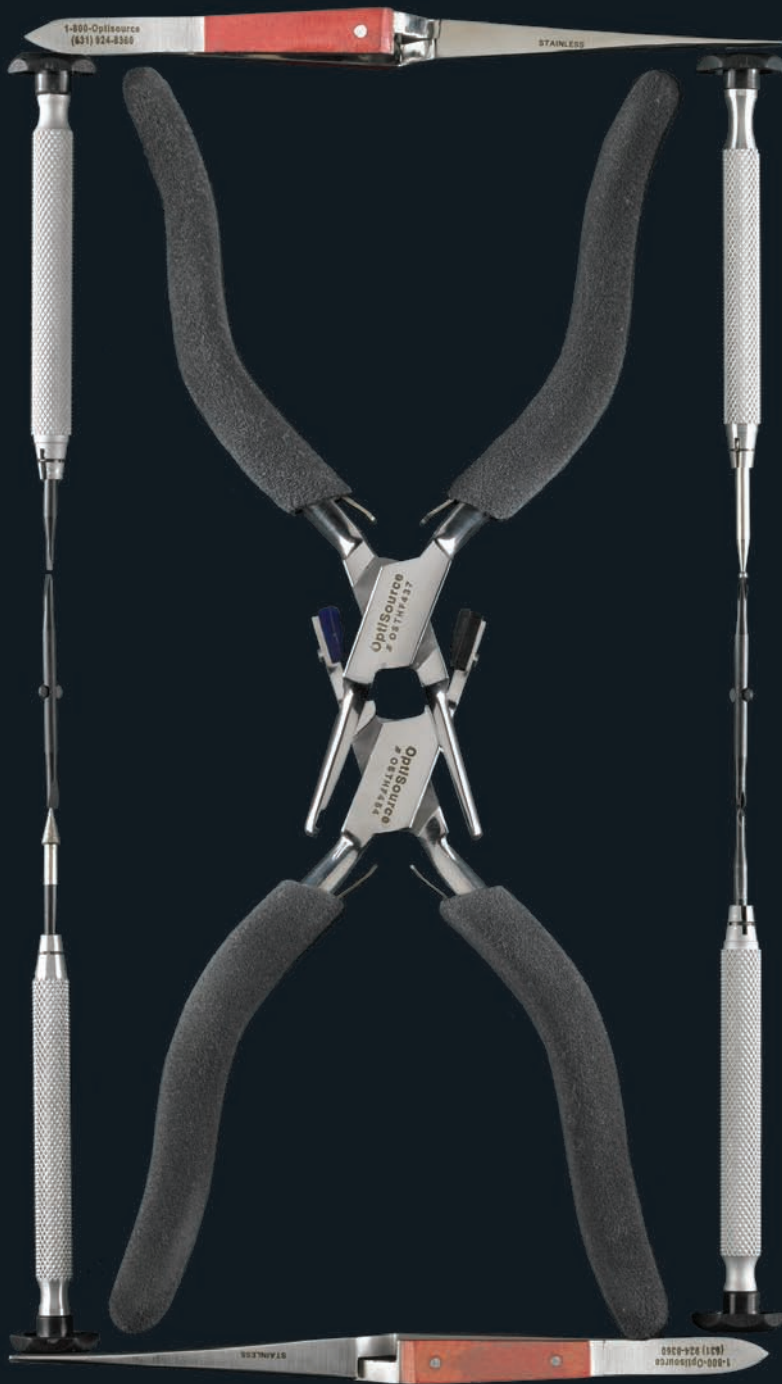

# TOOLS

## Timeless Designs

An eye care professional's skills are only limited by the tools with which he has to work. OptiSource makes sure that those skills never stop improving. Our collection of tools includes innovative, one-of-a-kind designs, ergonomically correct designs, and the indispensable **Timeless Designs** needed for repairs, adjustments, assembly, and measuring. Our hand-friendly pliers include an industry-exclusive lifetime guarantee.

## 9-Piece Rimless Driver-Bit Set

Everything you would ever need to complete or repair quality rimless work.

- Case organizes all tips and driver handle
- Includes 9 attachments for use with driver handle or most drill machines

78-TA04B \$64.99



Included bits (from left to right):

- 1.0mm Drill Bit
- 1.2mm Drill Bit
- 1.4mm Drill Bit
- 1.5mm Drill Bit
- Flat Blade
- Phillips Blade
- Screw Finisher
- Lens Back-side Countersink Bit
- Lens Front-Side Countersink Bit



## Rimless Scribe Tool

- Clean and size drilled rimless holes



34-280 \$19.99

## Nylon Line Hook

- Assists in the application of interliner



78-TA48 \$7.99

## Rimless Hole Beveling Tool

- Deburs drilled rimless holes



Replacement Tip

34-438 \$17.99

Replacement Tip  
34-438RT \$5.99

## Screw Finisher Tool

- Rounds jagged edges of cut screws



34-318 \$14.99

## Compression Sleeve Removal Tool



34-056 \$9.99

## Lens Clock

- Determines the base curve of plastic lenses
- Precision instrument



32-LENSCLOCK \$59.99

## 9-Piece Deluxe Screwdriver Set w/Swivel Base

Phillips-Head, Flat-Head, Hex, and Star Screwdrivers

- 2 Flat-heads: 1.6, 1.8
- 2 Phillips-heads: 1.5, 1.8
- 3 Hex tips: 2.02, 2.32, 2.57
- 2 Star tips: 2.52, 2.82
- Heavy weight swivel base

9-Piece Screwdriver Set 78-TA19B \$64.99

### Replacement Tips (3 Pack)

Flat - 1.6mm	78-TA19B-011RT
Flat - 1.8mm	78-TA19B-021RT
Phillips - 1.5mm	78-TA19B-031RT
Phillips - 1.8mm	78-TA19B-041RT
Hex - 2.02mm	78-TA19B-051RT
Hex - 2.32mm	78-TA19B-061RT
Hex - 2.57mm	78-TA19B-071RT
Star - 2.52mm	78-TA19B-081RT
Star - 2.82mm	78-TA19B-091RT

**\$5.99**  
3 pack

### Replacement Drivers w/Tips

Flat - 1.6mm	78-TA19B-011
Flat - 1.8mm	78-TA19B-021
Phillips - 1.5mm	78-TA19B-031
Phillips - 1.8mm	78-TA19B-041
Hex - 2.02mm	78-TA19B-051
Hex - 2.57mm	78-TA19B-061
Hex - 2.57mm	78-TA19B-071
Star - 2.52mm	78-TA19B-081
Star - 2.82mm	78-TA19B-091

**\$6.99**  
each





## Hand-Friendly Ergonomic Pliers

- Non-slip cushion grip
- Smooth-action spring eliminates sticking
- Polished stainless steel construction
- Lifetime guarantee

Our Hand-Friendly Ergonomic Pliers are built with your comfort in mind. Cushioned handles are tailored for ease of use while maintaining the professional functionality of each specific plier.

### Compression Sleeve Assembly Pliers

- Designed for easy assembly of 3-piece mount frames
- Works with all compression sleeves

34-OSTHF452 \$29.99

Replacement Tips  
34-OSTHF452RT \$2.99

### Compression Sleeve Removal “Push” Pliers

- Easily pushes out broken or damaged compression sleeves
- Nylon jaws protect the lens surface

34-OSTHF454 \$29.99

Replacement Tips  
34-OSTHF454RT \$2.99

### Compression Sleeve Trimming Pliers

- Trim away long bushings for a precise fit
- Sharp jaws do not crush soft plastic sleeves

34-OSTHF456 \$29.99



## Compression Sleeve Removal “Pull” Pliers

- Designed for easy removal of compression sleeves
- Helps prevent damage to expensive frames and lenses

34-OSTHF453      \$29.99



## 3-Piece Frame Adjusting Pliers

- Contoured jaws cradle temple and compression sleeve
- Easily adjusts fragile drill-mount frames
- Helps prevent damage to expensive lenses

34-OSTHF435      \$29.99

Replacement Tips  
34-OSTHF435RT      \$2.99



## Lens Screw Holding Pliers

- Hold end piece of rimless frame to make adjustments to pantoscopic tilt
- Securely cradle lens screws for precise adjustments

34-OSTHF717      \$29.99

Replacement Tips  
34-OSTHF717RT      \$2.99



## Hand-Friendly Ergonomic Pliers

### Lens Aligning Pliers

- Use for making precise axis adjustments
- Swivel pads conform to any lens

34-OSTHF432 \$29.99

Replacement Tips  
34-OSTHF432RT \$2.99



### Eyewire Shaping Pliers

- Reshape metal eyewires to conform with lens curvatures
- Double-leaf spring design for convenience and comfort

34-OSTHF434 \$29.99

Replacement Tips  
34-OSTHF434RT \$2.99



### Eyewire Bending Pliers

- Reform eyewire or add face curve to a flat frame front
- Adjust bridges and temple tips

34-OSTHF613 \$29.99

Replacement Tips  
34-OSTHF613RT \$2.99





## Eyewire Bending Pliers

- Used to bend or straighten eyewires, temples, or nose pad arms
- Trident design provides leverage for finite adjustments

34-OSTHF1513      \$29.99



## Tapered Eyewire Closure Pliers

- Tapered pin on one jaw holds metal eyewire closed to accurately size lens during edging
- Won't strip screw threads

34-OSTHF011      \$29.99



## Lens Sizing Pliers

- Provides excellent control and leverage for controlled eyewire closure
- Angled head reduces hand strain
- Also useful for flaring rivets and peening screws

34-OSTHF429      \$34.99



## Hand-Friendly Ergonomic Pliers

### Nose Pad Arm Anvil Pliers

- Make precise adjustments to nose pad arms
- Small tips fit easily in tight areas

34-OSTHF863      \$29.99



### Slim Nose Pad Arm Adjusting Pliers

- Designed for adjusting most nose pad arm configurations
- Concave jaw supports nose pad mount

34-OSTHF437      \$29.99



### Crimp-On Nose Pad Crimping Pliers

- Attach crimp-on style nose pads securely
- Precisely folds crimp-on tabs for a secure fit

34-OSTHF235      \$29.99



## Nose Pad Removal Pliers

- Pushes nose pad out of its holder
- Use with all snap-style nose pads

34-OSTHF379 \$29.99



## Numont Pliers

- Opposing grooves in jaws secure frames for precision end piece adjustment
- Grooves provide support for temple angle modification

34-OSTHF214 \$29.99



## Bent Post Pliers

- Use to brace and grip hinge barrels
- Jaws parallel at 5mm; jaw width is 3.5mm
- Jaws bend at 45° angle

34-OSTHF008 \$24.99





## Hand-Friendly Ergonomic Pliers

### Bridge Reducing Pliers

- Jaw system holds bridge from both sides for a precise bridge reduction
- For metal and plastic frames

34-OSTHF129 \$29.99

Replacement Tips  
34-OSTHF129RT \$2.99



### Temple Bending Pliers

- For adjustments to both plastic and metal temples
- Strong and smooth nylon jaws
- Double-leaf spring designed for convenience

34-OSTHF433 \$29.99

Replacement Tips  
34-OSTHF433RT \$2.99



### Wide Jaw Angling Pliers

- Use to make pantoscopic and retroscopic angle adjustments
- Wide jaws accommodate even the thickest temples
- Also useful for modifying end pieces

34-OSTHF401 \$29.99



## Inclination Pliers

- Triangular metal jaw cradles hinges for extra support when making delicate adjustments
- 10mm wide jaws

34-OSTHF557 \$29.99

Replacement Tips  
34-OSTHF557RT \$2.99



## Flat/Round Snipe Pliers

- All-purpose adjusting pliers
- Double-leaf spring designed for comfort and convenience

34-OSTHF430 \$29.99



## Screw Extraction Pliers

- Remove broken screws with ease
- Double-leaf spring designed for convenience and comfort
- Foam cushioned handles for non-slip gripping

34-OSTHF038 \$29.99



## Hand-Friendly Ergonomic Pliers

### Round Metal/Flat Nylon Pliers

- Flat nylon jaw prevents marring of frame
- End piece wraps around jaw to easily bring temples in or out
- For use on full metal and semi-rimless frames

34-OSTHF412 \$29.99

Replacement Tips  
34-OSTHF412RT \$2.99

### Double Nylon Jaw Pliers

- Holds plastic or metal frames without marring
- 10mm wide jaw

34-OSTHF014 \$29.99

Replacement Tips  
34-OSTHF014RT \$2.99

### Narrow Double Nylon Pliers

- Holds plastic or metal frames without marring
- 8mm wide jaw

34-OSTHF053 \$29.99

Replacement Tips  
34-OSTHF053RT \$2.99





## Nylon Gripping Pliers

- Smooth and tough nylon jaw protects frames
- Double-leaf spring designed for convenience and comfort

34-OSTHF405 \$29.99

Replacement Tips  
34-OSTHF405RT \$2.99



## Flat Chain Nose Pliers

- Provides excellent control and leverage for the best adjustments
- Use to adjust temples, bridges, and pad arms
- Great for any kind of holding or shaping work

34-OSTHF410 \$29.99



## Long Snipe Nose Pliers

- Long tapered-nose pliers for adjustments in tight areas
- Double-leaf spring design for convenience

34-OSTHF428 \$39.99



## Hand-Friendly Ergonomic Pliers

### Bent Snipe Nose Pliers

- Angled jaws for easy adjustments in tight places
- Polished stainless steel construction

34-OSTHF431      \$29.99



### Heavy Duty Side Cutting Pliers

With Tungsten-Carbide Tips

- Easily cut screws for temple-ends for a clean finish
- Available in right-hand and left-hand configurations
- Has an 11mm cutter length and an overall 160mm length

R-Hand 34-OSTHF424      \$39.99  
L-Hand 34-OSTHF425      \$39.99



### Chappel Cutting Pliers

With Tungsten-Carbide Tips

- Chips away excess lens or blank material
- Cuts nickel-silver screws and rivets
- Double-leaf spring designed for convenience

34-OSTHF451      \$39.99



## Heavy-Duty Cutting Pliers

With Tungsten-Carbide Tips

- Extended handles for added strength and cutting power
- Excellent for cutting core wires and heavy nickel-silver screws
- Double-leaf spring designed for convenience and comfort

34-OSTHF039 \$39.99



## 6" Top Cutting Pliers

With Tungsten-Carbide Tips

- Double-action hinges increase applied force
- Cuts stainless steel screws and rivets
- Design allows for flush cuts in tight areas
- Total length of the pliers is 6 inches

34-OSTHF023-6TOP \$49.99



## Leverage Screw Cutting Pliers

- Safely cut silver and brass screws on rimless frames
- Not suitable for steel screws

34-OSTHF578 \$29.99



## Hand-Friendly Ergonomic Pliers

### Large Deblocking Pliers

- Removes blocks quickly and easily without damaging lenses
- 14mm diameter

34-OSTHFDEBL \$34.99



### Small Deblocking Pliers

- Removes blocks quickly and easily without damaging lenses
- 11mm diameter

34-OSTHFDEBLS \$34.99



### Angled Deblocking Pliers

- The angled design decreases stress for safer deblocking on AR coated lenses
- Fits all 14mm blocks

34-OSTHFDEBLANG \$34.99





## Titanium Pliers

- A selection of our ten best-selling pliers
- Buy individually or as a set
- Internal box spring made of pure titanium

### Eyewire Shaping Pliers

- Reshape metal eyewires to conform with lens curvatures
- Internal spring design for convenience and comfort

34-OSTTT434 \$49.99

Replacement Tips  
34-OSTTT434RT \$3.99



Our Titanium tools are another OptiSource exclusive product. Never before have optical pliers been so carefully designed and precision manufactured. The close attention to detail can be seen from the tight tolerances in the jaws down to the milled logo in the handles. All titanium tools are designed with an internal box spring made of pure titanium, stainless steel handles and jaws, and finished with a blue iridescent titanium coating.

### Double Nylon Jaw Pliers

- Holds plastic or metal frames without marring
- 10mm wide jaw

34-OSTTT014 \$49.99

Replacement Tips  
34-OSTTT014RT \$3.99



## Titanium Pliers

### Cutting Pliers

With Tungsten-Carbide Tips

- Easily cut screws for temple-ends for a clean finish
- Has an 11mm cutter length

34-OSTTT424      \$54.99



### Lens Aligning Pliers

- Use for making precise axis adjustments
- Swivel pads conform to any lens

34-OSTTT432      \$54.99

Replacement Tips  
34-OSTTT432RT      \$3.99



## Compression Sleeve Assembly Pliers

- Designed for easy assembly of 3-piece mount frames
- Works with all compression sleeves

34-OSTTT452 \$49.99

Replacement Tips

34-OSTTT452RT \$3.99



## Deblocking Pliers

- The angled design decreases stress for safer deblocking on AR coated lenses
- Fits all 14mm blocks

34-OSTTTDEBLANG \$49.99



## Titanium Pliers

### Slim Nose Pad Arm Adjusting Pliers

- Designed for adjusting most nose pad arm configurations
- Concave jaw supports nose pad mount

34-OSTTT437      \$49.99



### Nylon Gripping Pliers

- Smooth and tough nylon jaw protects frames
- Internal spring design for convenience and comfort

34-OSTTT405      \$49.99

Replacement Tips  
34-OSTTT405RT      \$3.99





## Long Snipe Nose Pliers

- Long tapered-nose pliers for adjustments in tight areas
- Internal spring design for convenience and comfort

34-OSTTT428 \$49.99



## Round Metal/Flat Nylon Pliers

- Flat nylon jaw prevents marring of frame
- End piece wraps around jaw to easily bring temples in or out
- For use on full metal and semi-rimless frames

34-OSTTT412 \$49.99

Replacement Tips  
34-OSTTT412RT \$3.99



## Lady's Pliers

- A selection of our ten best-selling pliers
- Buy individually or as a set
- Sales benefit Breast Cancer Research Foundation

Our Lady's pliers are designed specifically to fit smaller hands. The comfortable rubberized grip is emblazoned with the pink Breast Cancer Awareness Ribbon. A portion of the proceeds from the sale of our Lady's Tools will be donated to the Breast Cancer Research Foundation ([www.bcrfure.org](http://www.bcrfure.org)). All OptiSource pliers carry our unmatched lifetime guarantee.

## Nylon Gripping Pliers

- Smooth and tough nylon jaw protects frames
- Internal spring designed for convenience and comfort

34-OSTLL405 \$29.99

Replacement Tips  
34-OSTLL405RT \$3.99

## Compression Sleeve Assembly Pliers

- Designed for easy assembly of 3-piece mount frames
- Works with all compression sleeves

34-OSTLL452 \$29.99

Replacement Tips  
34-OSTLL452RT \$3.99



## Slim Nose Pad Arm Adjusting Pliers

- Designed for adjusting most nose pad arm configurations
- Concave jaw supports nose pad mount

34-OSTLL437 \$29.99



## Double Nylon Jaw Pliers

- Holds plastic or metal frames without marring
- 10mm wide jaw

34-OSTLL014 \$29.99

Replacement Tips  
34-OSTLL014RT \$3.99



## Lady's Pliers

### Eyewire Shaping Pliers

- Reshape metal eyewires to conform with lens curvatures
- Double-leaf spring design for convenience and comfort

34-OSTLL434      \$29.99

Replacement Tips

34-OSTLL434RT      \$3.99



### Lens Aligning Pliers

- Use for making precise axis adjustments
- Swivel pads conform to any lens

34-OSTLL432      \$29.99

Replacement Tips

34-OSTLL432RT      \$3.99





## Round Metal/Flat Nylon Pliers

- Flat nylon jaw prevents marring of frame
- End piece wraps around jaw to easily bring temples in or out
- For use on full metal and semi-rimless frames

34-OSTLL412 \$29.99

Replacement Tips

34-OSTLL412RT \$3.99



## Deblocking Pliers

- The angled design decreases stress for safer deblocking on AR coated lenses
- Fits all 14mm blocks

34-OSTLLDEBLANG \$34.99



## Lady's Pliers

### Cutting Pliers

With Tungsten-Carbide Tips

- Easily cut screws for temple-ends for a clean finish
- Has an 11mm cutter length and an overall 160mm length

34-OSTLL424

\$39.99



### Long Snipe Nose Pliers

- Long tapered-nose pliers for adjustments in tight areas
- Double-leaf spring design for convenience

34-OSTLL428

\$39.99



## Multi-Tool Holder w/Drawers



Tools Not Included



- Made from rigid plastic mounted on a turntable for easy access to all tools
- 2 drawers in the front hold frame parts
- Holds 6 screwdrivers and up to 8 pliers

78-TB07 \$59.99

## Tool Case

- Neatly and securely holds 10 pliers
- Heavy duty zipper
- Durable leatherette material



34-TOOLCASE \$29.99

## Handle Sleeves

Are the Hand Grips on Your Pliers Getting Old and Worn Out?

Instead of replacing your pliers, just change the handle sleeves. These durable cushioned handle sleeves provide excellent comfort and extend the life of your tools.



34-OSTBLKFOAM \$5.99

## Tool Holders

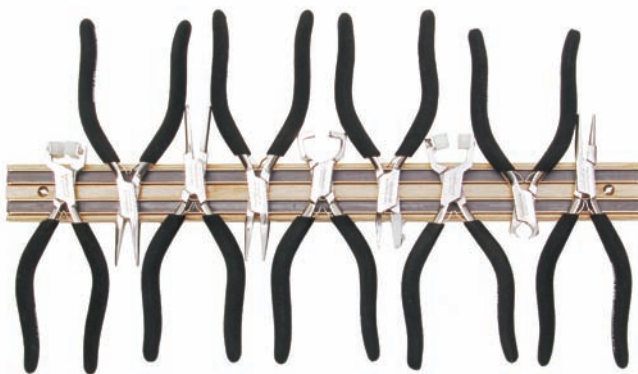

Tools Not Included

24" Magnetic Wall Bar Tool Holder



Tools Not Included

9" Metal Table-Top Tool Holder



Curved Plastic Tool Rack

24" Magnetic Wall Bar	34-HOLDMAGNET	\$29.99
9" Metal Table-Top	34-HOLDMETAL	\$11.99
Curved Plastic Tool Rack	78-TB08	\$54.99

## Tool Kits



### 10-Piece Titanium Tool Kit

This set of ten Titanium pliers is a selection of our best selling tools. The travel case is a luxurious and durable storage solution.

- Slim Pad Arm Adjusting Pliers
- Eyewire Shaping Pliers
- Lens Aligning Pliers
- Nylon Gripping Pliers
- Flat/Round Metal Pliers
- Side Cutter Pliers (right)
- Long Snipe Nose Pliers
- Angled Deblocking Pliers
- Double Jaw Nylon Pliers
- Compression Sleeve Assembly Pliers

34-OSTT-SET10 \$499.99



### 10-Piece Lady's Tool Kit

This set of ten Lady's pliers is a selection of our best selling tools. The travel case is a luxurious and durable storage solution. Sales benefit Breast Cancer Research Foundation.

- Slim Pad Arm Adjusting Pliers
- Eyewire Shaping Pliers
- Lens Aligning Pliers
- Nylon Gripping Pliers
- Flat/Round Metal Pliers
- Side Cutter Pliers (right)
- Long Snipe Nose Pliers
- Angled Deblocking Pliers
- Double Jaw Nylon Pliers
- Compression Sleeve Assembly Pliers

34-OSTKLL \$299.99



## Tool Kits



### 8-Piece Hand-Friendly Tool Kit

This 8-piece hand-friendly tool set is designed with your comfort in mind. Cushioned handles are tailored for ease of use while maintaining the professional functionality of each specific tool.

- Wide Jaw Angling Pliers
- Nylon Gripping Pliers
- Lens Axis Aligning Pliers
- Chain Nose Pliers
- Flat/Round Metal Pliers
- Temple Bending Pliers
- Pad Arm Adjusting Pliers
- Narrow Double Nylon Pliers

34-OSTKHF      \$229.99



### 11-Piece Rimless Hand-Friendly Tool Kit

This 11-piece hand-friendly tool set is designed with your comfort in mind. Contains eleven rimless hand-friendly tools critical for assembly and adjusting of rimless work. Entire set fits in a tailored leatherette case for easy storage and carrying.

- Wide Jaw Angling Pliers
- Flat/Round Pliers
- Pad Arm Adjusting Pliers
- Narrow Double Nylon Pliers
- 3-Piece Rimless Pliers
- Compression Frame Removal Pliers
- Compressing Pliers
- Compression Sleeve Trimming Pliers
- Compressing Sleeve Punch Pliers
- Hole Beveling Tool
- Scribe

34-OSTKRIMLESS      \$254.99

## Optical Tweezer



34-OST030 \$7.99

## Insulated Curved Self-Closing Tweezer



34-OST031 \$7.99

## Insulated Self-Closing Tweezer



34-OST032 \$7.99

## Self-Closing Optical Tweezer



- Grooved tip designed to hold screw head



34-OST033 \$9.99

## Pad Removing Tweezer



34-OST034 \$7.99

## Nylon-Brass Mallet



- Dual-headed, all-purpose mallet
- Brass head for firm strikes
- Nylon head for delicate, non-marking strikes

34-OST108 \$11.99

## Riveting Hammer



- Use for close work on rivets or other small parts
- Balanced design for precision work

34-OST109 \$11.99

## All-Purpose Lab Snips



- Excellent for hand-cutting plastic pattern blanks
- All-purpose snips feature comfort handles

34-OST299 \$6.99

## Soldering Clamps

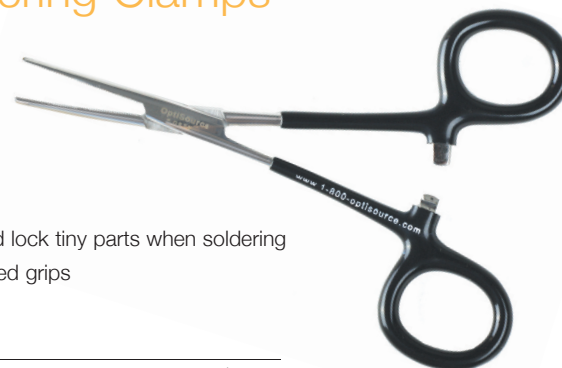

- Hold and lock tiny parts when soldering
- Cushioned grips

Straight	34-OST040	\$7.99
Curved	34-OST041	\$7.99

## Lens Hole Gauge

- Easily measure lens holes
- Measure 20 different hole sizes

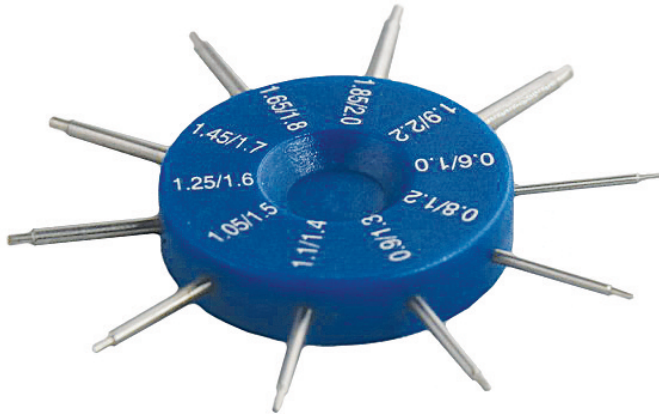

78-TA16B \$18.99

## Hex Nut Wrenches

\$9.99 each

2.2mm hex wrench



2.5mm hex wrench



2.2mm 34-SL312  
2.5mm 34-SL311

## Screw Gripper

Hold and lock screws and nuts in position while either removing or placing screws and nuts.



78-TA20D \$12.99

## Aluminum Handle Reversible Screwdrivers

\$7.99 each

Phillips-Head or Flat-Head Blades Available



- Shaft constructed of aluminum
- Pull-out, double-ended blade and reverse to switch head sizes

Phillips-Head 1.6/2.0mm 34-SLSDPHIL  
Flat-Head 1.6/2.2mm 34-SLSDFLAT

## Brass Handle Reversible Screwdrivers

\$15.99 each

Solid Brass Shaft with Anti-Roll Top

- Thick, textured handle
- Super-smooth spinning
- Reversible blades
- Anti-roll top removes for storage of extra blades



Phillips-Head 1.6/2.0mm 34-SL105A  
Flat-Head 1.6/2.2mm 34-SL113

## Replacement Blades

\$7.99 per pack

- Fits aluminum and brass screwdrivers on this page
- New and improved hardened steel



Hex Nut Tip 2.2



Hex Nut Tip 2.5



Phillips-Head Reversible



Flat-Head Reversible

Hex Nut Tip 2.2mm 1 Blade 34-HEXRP2.2  
Hex Nut Tip 2.5mm 1 Blade 34-HEXRP2.5  
Phillips-Head 1.6/2.0mm 4 Blades 34-PHILLIPS  
Flat-Head 1.6/2.2mm 4 Blades 34-FLATHEAD

## 10-Piece Mini-File Set

- Compact organizer case
- Variety of file shapes and finishes



78-TA64 \$24.99

## Files



### Bent Flat Needle File



68-LI-252 \$12.99



### Half-Round File



68-LI-151 \$7.99



### Round File



68-LI-152 \$7.99



### Plate File



68-LI-150 \$7.99

## Wood Handle Files



### Flat

68-LI-110 \$11.99



### Half-Round

68-LI-113 \$14.99



### Flat Double Cut

68-LI-130 \$27.99



### Half-Round

68-LI-165 \$29.99



### Screw Head Finishing

68-LI-250/50 \$42.99





# Screw Extractor Kit



- Made from zinc alloy and copper
- Easily remove broken or stripped screws
- Rethread stripped barrels

Screws Extractor	78-T004	\$59.99
------------------	---------	---------

### Replacement Parts

1.0 bit	78-T004B-1.0	\$3.99
1.2 bit	78-T004B-1.2	\$3.99
1.2 tap	78-T004C-1.2	\$3.99
1.4 tap	78-T004C-1.4	\$3.99
1.6 tap	78-T004C-1.6	\$3.99
1.0 cap	78-T004D-1.0	\$9.99
1.2 cap	78-T004D-1.2	\$9.99
0.9 needle	78-T004E-.9	\$14.99
1.1 needle	78-T004E-1.1	\$14.99
Replacement anvil	78-T004F	\$9.99

## Clavulus Hand Press

The Clavulus Hand Press is a staple tool for the consummate optical professional. It is constructed of stainless steel for the highest quality and smooth operation.

- Perform dozens of repairs and adjustments on this precision tool
- Made of stainless steel for years of continuous performance
- Heavy weight aluminum base



Includes:

- Peening punch
- Riveting punch
- Flaring punch
- Rivet puller
- Punch for Spread Hinges
- Single punch
- Double punch
- Anvils

Dimensions (W x H x D):  
135 x 290 x 175mm



34-HANDPRESS \$219.99

Replacement parts available online at [www.1-800-OptiSource.com](http://www.1-800-OptiSource.com)

## Helping Hands

Need a third hand for those difficult repair jobs? Our Helping Hands repair station is designed to hold the frame securely while you perform delicate repairs.



- Weighted base prevents slipping
- Adjustable alligator clips grip down firmly
- Hinged bar allows for easy positioning

99-HELPINGHANDS \$14.99

## Anvil Bench Block

Our bench top anvil is the perfect repair companion. It saves your countertop from gouges and scratches and provides round contour for leverage and shaping.



34-ANVIL \$38.99

## Hockey Puck Bench Block

The name says it all. The OptiSource Hockey Puck is the perfect anti-slip work surface for hinge and other repairs. Includes double-sided tape to stick to the bench top.



99-BENCHPUCK \$14.99

## Rimless Assembly Measuring Tool

Our Rimless Assembly Measuring Tool is a precision instrument that allows you to check the accuracy of your drilled rimless work. The cross-grids are etched with numbered scales to measure both horizontally and vertically from different reference points on the frame.

- Checks rimless accuracy
- Precision milled aluminum
- Numbered scales and rule

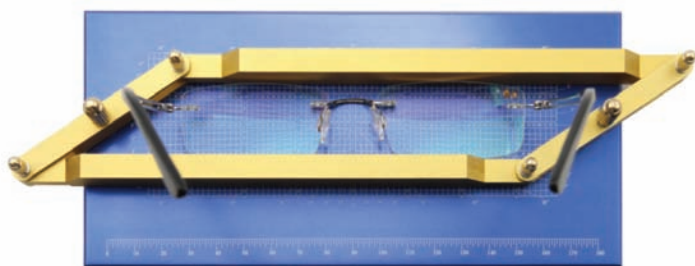
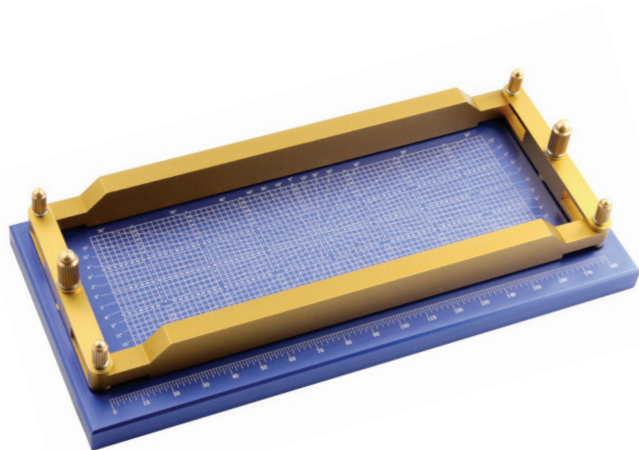

78-T012B \$69.99

## Digital Caliper

- Precisely measures screws, holes, parts, and more
- Range: 0-100mm



78-TA43 \$59.99

## Calipers

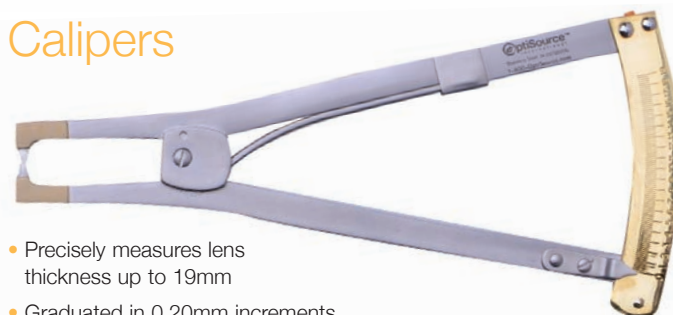

- Precisely measures lens thickness up to 19mm
- Graduated in 0.20mm increments
- Stainless steel with brass index plate



Lens Thickness Caliper	34-OST001CAL	\$29.99
Wide Jaw Caliper	34-OST110	\$29.99

## 3x Zelco FLX Tabletop Lumifier with 5x bifocal



This high-quality, optical grade, 3x magnifying lens with a 4" diameter is ideal for optical professionals during frame assembly and repair. The soft touch switch illuminates the three super bright, cool white LED bulbs.

- Three super bright LED bulbs
- Requires 4 "AA" batteries (not included)

35-570285 \$52.92



## PD Rulers

Our PD rulers are multifunctional, indispensable tools. Not only do they accurately measure pupillary distance with three different printed scales, but they will also help during dispensing with a notched hinge-measuring edge and screw thickness gauge (both printed on the rear of the ruler). They are comfortable, lightweight, and medium thickness.

- Choose from two different styles

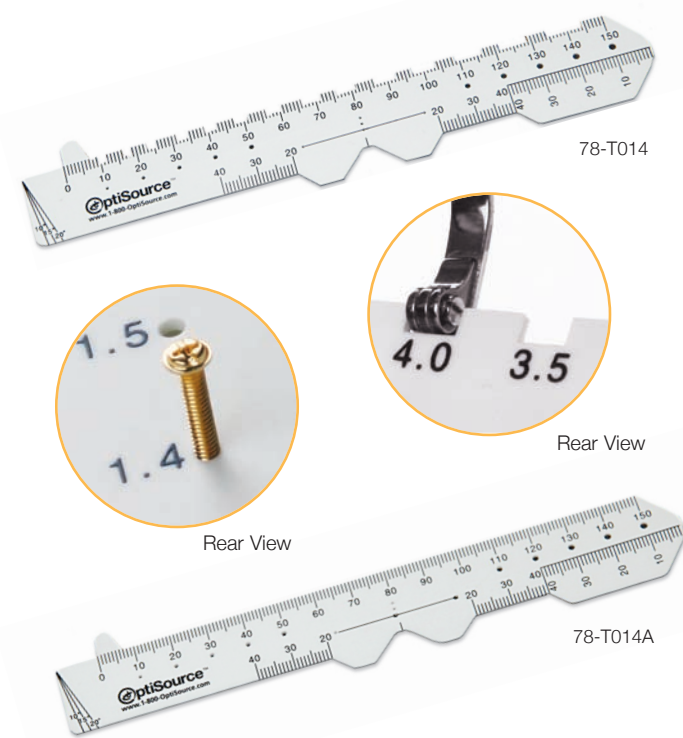

Multi-Function PD Ruler	78-T014	\$1.69
Straight Edge PD Ruler	78-T014A	\$1.69

Custom printing available (1,000 pc. minimum)

## Wood and Plastic PD Ruler



- Real wood design with high-contrast polymer-backed metric scale
- Millimeters on the front and inches on the back

99-PDWOOD	\$6.99
-----------	--------

## Distometer

### Take the Fuss Out of Vertex Measurements with our Distometer

- Incorrect vertex distance will change the effective power of a prescription
- Avoid costly remakes and troubleshooting time by measuring vertex accurately
- With each distometer, you will receive a conversion scale for easy calculations

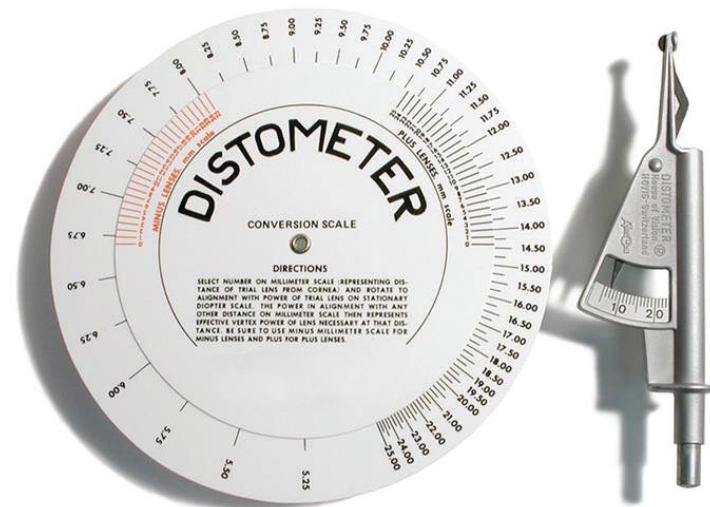

86-DISTOMETER	\$182.99
---------------	----------

## PAL Fitting Tool

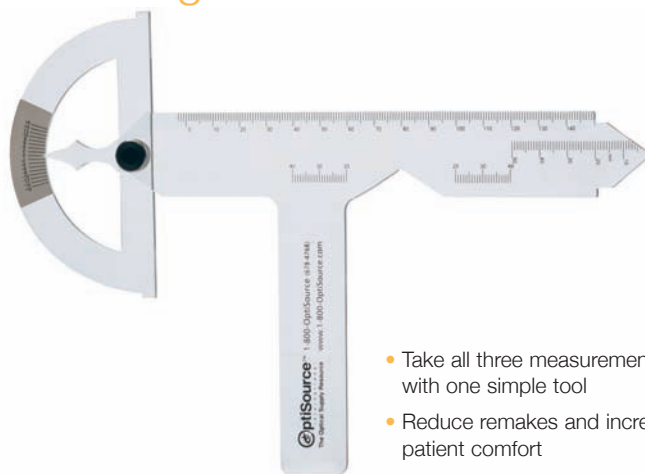

- Take all three measurements with one simple tool
- Reduce remakes and increase patient comfort

Our PAL Fitting Tool is designed to easily measure your patient's PD, Pantoscopic Tilt, and Vertex Distance. This tool will help ensure that your patient's lenses will be properly aligned with their position-of-wear.

78-PALFITTOOL	\$22.99
---------------	---------





# FRAME PARTS

Prepared for Repair

Today's frame styles — from classic designs to cutting edge — continue to challenge us with new or unique hardware to assemble and repair. OptiSource offers one of the largest selections of staple frame screws, rimless hardware, and nose pad collections to keep you Prepared for Repair. Our patented Snapit™ frame screws have changed the way repair and assembly work gets done around the world. We offer the most comprehensive variety of rimless assembly parts: sizes, shapes, and materials.



Snap



**Snapit**  
frame screws



New and Improved Design  
Breaks Cleaner, Smoother, and Flatter

OptiSource International is the exclusive manufacturer of Snapit™ patented frame screws. These high quality stainless steel screws have a unique, extra long feeder tip that makes handling screws a cinch and repairs a pleasure.

After the screw is inserted into any hinge or eyewire, the long feeder tip simply snaps off cleanly with just your fingers leaving a smooth finish. Clipping and filing is eliminated. All Snapit™ screws will self-align, self-tap stripped threads, and include the OptiSource Stay-Tight™ thread lock.

- Eyewires, Hinges, Spring Hinges
- Self Aligns, Self Taps
- Includes Stay-Tight™ thread lock
- Available in Silver, Gold, Gunmetal, and Black
- Protected by US and International Patents\*



Align



Screw



Snap

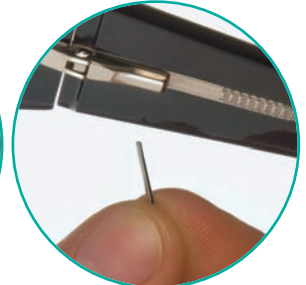

Remove

Screw it in, Snap it off

**Flat-Head**

Vials - 50 Screws

Silver	\$19.75
Gold	\$21.75
Gunmetal	\$21.75
Black	\$21.75

Bulk - 200 Screws

Silver	\$72.99
Gold	\$75.99

Assorted Screws - 250 Screws

Silver	02-SILVERWHEEL	\$109.75
Gold	02-GOLDWHEEL	\$119.75

**Phillips-Head**

Vials - 50 Screws

Silver	\$22.75
Gold	\$24.75
Gunmetal	\$24.75
Black	\$24.75



\*PATENT NUMBERS:  
USA - 8070403, 8375546, 8556556  
Australia - 2008283850, 2011101044  
China - 2L2008 80102133.2  
Philippines - 1/2010/500274  
South Africa - 2010/03664  
Russia - 2493446

**Snapit Eyeglass Repair Kit**



Kit includes 5 Snapit screws and a screwdriver in a convenient storage tube.



- Display holds 12 repair kits
- Sold in cases of 24

02-REPAIRKIT Each \$1.99

# Phillips-Head Size Guide

# Flat-Head Size Guide

## Silver Vials

	Thread x Length x Head	Code
Eyewire	1.2 x 4.0 x 1.8	02-124018-P
	1.3 x 4.0 x 1.8	02-134018-P
	1.4 x 3.0 x 1.8	02-143018-P
	1.4 x 4.0 x 1.8	02-144018-P
	1.5 x 4.0 x 1.8	02-154018-P
Hinge	1.3 x 3.5 x 2.0	02-133520-P
	1.4 x 3.5 x 2.0	02-143520-P
	1.4 x 4.0 x 2.0	02-144020-P
	1.4 x 4.8 x 2.0	02-144820-P
	1.5 x 4.0 x 2.0	02-154020-P

## Gold Vials

	Thread x Length x Head	Code
Eyewire	1.3 x 4.0 x 1.8	02-134018G-P
	1.4 x 4.0 x 1.8	02-144018G-P
Hinge	1.4 x 3.5 x 2.0	02-143520G-P
	1.4 x 4.0 x 2.0	02-144020G-P
	1.5 x 4.0 x 2.0	02-154020G-P

## Gunmetal Vials

	Thread x Length x Head	Code
Eyewire	1.3 x 4.0 x 1.8	02-134018GM-P
	1.4 x 4.0 x 1.8	02-144018GM-P
Hinge	1.4 x 3.5 x 2.0	02-143520GM-P
	1.4 x 4.0 x 2.0	02-144020GM-P
	1.5 x 4.0 x 2.0	02-154020GM-P

## Black Vials

	Thread x Length x Head	Code
Eyewire	1.3 x 4.0 x 1.8	02-134018BK-P
	1.4 x 4.0 x 1.8	02-144018BK-P
Hinge	1.4 x 3.5 x 2.0	02-143520BK-P
	1.4 x 4.0 x 2.0	02-144020BK-P
	1.5 x 4.0 x 2.0	02-154020BK-P



## Snapit Vial Holder

Holds 16 Snapit vials and 5 screwdrivers  
(Vials and screwdrivers sold separately)

02-DISPLAY \$29.99

## Gunmetal Vials

	Thread x Length x Head	Code
Eyewire	1.2 x 4.0 x 1.8	02-124018GM
	1.3 x 4.0 x 1.8	02-134018GM
	1.4 x 3.0 x 1.8	02-143018GM
	1.4 x 4.0 x 1.8	02-144018GM
	1.5 x 4.0 x 1.8	02-154018GM
Hinge	1.3 x 3.5 x 2.0	02-133520GM
	1.4 x 3.5 x 2.0	02-143520GM
	1.4 x 4.0 x 2.0	02-144020GM
	1.4 x 4.8 x 2.0	02-144820GM
	1.5 x 4.0 x 2.5	02-154020GM

## Silver Vials

	Thread x Length x Head	Code	
Eyewire	1.2 x 4.0 x 1.8	02-124018	
	1.2 x 4.8 x 1.8	02-124818	
	1.3 x 3.0 x 1.8	02-133018	
	1.3 x 4.0 x 1.8	02-134018	
	1.3 x 4.8 x 1.8	02-134818	
	1.4 x 3.0 x 1.8	02-143018	
	1.4 x 4.0 x 1.8	02-144018	
	1.4 x 4.8 x 1.8	02-144818	
	1.5 x 3.0 x 1.8	02-153018	
	1.5 x 4.0 x 1.8	02-154018	
	1.5 x 4.8 x 1.8	02-154818	
	Hinge	1.3 x 3.5 x 2.0	02-133520
		1.4 x 3.5 x 2.0	02-143520
		1.4 x 4.0 x 2.0	02-144020
		1.4 x 4.0 x 2.5	02-144025
1.4 x 4.8 x 2.0		02-144820	
1.4 x 4.8 x 2.5		02-144825	
1.4 x 5.5 x 2.0		02-145520	
1.4 x 5.5 x 2.5		02-145525	
1.5 x 3.5 x 2.0		02-153520	
1.5 x 4.0 x 2.0		02-154020	
1.5 x 4.0 x 2.5		02-154025	
1.5 x 4.8 x 2.0		02-154820	
1.5 x 4.8 x 2.5		02-154825	
1.5 x 5.5 x 2.0		02-155520	
1.5 x 5.5 x 2.5		02-155525	

## Silver Bulk

	Thread x Length x Head	Code	
Eyewire	1.2 x 4.0 x 1.8	02-B124018	
	1.2 x 4.8 x 1.8	02-B124818	
	1.3 x 3.0 x 1.8	02-B133018	
	1.3 x 4.0 x 1.8	02-B134018	
	1.3 x 4.8 x 1.8	02-B134818	
	1.4 x 3.0 x 1.8	02-B143018	
	1.4 x 4.0 x 1.8	02-B144018	
	1.4 x 4.8 x 1.8	02-B144818	
	1.5 x 3.0 x 1.8	02-B153018	
	1.5 x 4.0 x 1.8	02-B154018	
	1.5 x 4.8 x 1.8	02-B154818	
	Hinge	1.3 x 3.5 x 2.0	02-B133520
		1.4 x 3.5 x 2.0	02-B143520
		1.4 x 4.0 x 2.0	02-B144020
		1.4 x 4.0 x 2.5	02-B144025
1.4 x 4.8 x 2.0		02-B144820	
1.4 x 4.8 x 2.5		02-B144825	
1.4 x 5.5 x 2.0		02-B145520	
1.4 x 5.5 x 2.5		02-B145525	
1.5 x 3.5 x 2.0		02-B153520	
1.5 x 4.0 x 2.0		02-B154020	
1.5 x 4.0 x 2.5		02-B154025	
1.5 x 4.8 x 2.0		02-B154820	
1.5 x 4.8 x 2.5		02-B154825	
1.5 x 5.5 x 2.0		02-B155520	
1.5 x 5.5 x 2.5		02-B155525	

## Black Vials

	Thread x Length x Head	Code
Eyewire	1.2 x 4.0 x 1.8	02-124018BK
	1.3 x 4.0 x 1.8	02-134018BK
	1.4 x 3.0 x 1.8	02-143018BK
	1.4 x 4.0 x 1.8	02-144018BK
	1.5 x 4.0 x 1.8	02-154018BK
Hinge	1.3 x 3.5 x 2.0	02-133520BK
	1.4 x 3.5 x 2.0	02-143520BK
	1.4 x 4.0 x 2.0	02-144020BK
	1.4 x 4.8 x 2.0	02-144820BK
	1.5 x 4.0 x 2.5	02-154020BK

## Gold Vials

	Thread x Length x Head	Code	
Eyewire	1.2 x 4.0 x 1.8	02-124018G	
	1.2 x 4.8 x 1.8	02-124818G	
	1.3 x 3.0 x 1.8	02-133018G	
	1.3 x 4.0 x 1.8	02-134018G	
	1.3 x 4.8 x 1.8	02-134818G	
	1.4 x 3.0 x 1.8	02-143018G	
	1.4 x 4.0 x 1.8	02-144018G	
	1.4 x 4.8 x 1.8	02-144818G	
	1.5 x 3.0 x 1.8	02-153018G	
	1.5 x 4.0 x 1.8	02-154018G	
	1.5 x 4.8 x 1.8	02-154818G	
	Hinge	1.3 x 3.5 x 2.0	02-133520G
		1.4 x 3.5 x 2.0	02-143520G
		1.4 x 4.0 x 2.0	02-144020G
		1.4 x 4.0 x 2.5	02-144025G
1.4 x 4.8 x 2.0		02-144820G	
1.4 x 4.8 x 2.5		02-144825G	
1.4 x 5.5 x 2.0		02-145520G	
1.4 x 5.5 x 2.5		02-145525G	
1.5 x 3.5 x 2.0		02-153520G	
1.5 x 4.0 x 2.0		02-154020G	
1.5 x 4.0 x 2.5		02-154025G	
1.5 x 4.8 x 2.0		02-154820G	
1.5 x 4.8 x 2.5		02-154825G	
1.5 x 5.5 x 2.0		02-155520G	
1.5 x 5.5 x 2.5		02-155525G	

## Gold Bulk

	Thread x Length x Head	Code	
Eyewire	1.2 x 4.0 x 1.8	02-B124018G	
	1.2 x 4.8 x 1.8	02-B124818G	
	1.3 x 3.0 x 1.8	02-B133018G	
	1.3 x 4.0 x 1.8	02-B134018G	
	1.3 x 4.8 x 1.8	02-B134818G	
	1.4 x 3.0 x 1.8	02-B143018G	
	1.4 x 4.0 x 1.8	02-B144018G	
	1.4 x 4.8 x 1.8	02-B144818G	
	1.5 x 3.0 x 1.8	02-B153018G	
	1.5 x 4.0 x 1.8	02-B154018G	
	1.5 x 4.8 x 1.8	02-B154818G	
	Hinge	1.3 x 3.5 x 2.0	02-B133520G
		1.4 x 3.5 x 2.0	02-B143520G
		1.4 x 4.0 x 2.0	02-B144020G
		1.4 x 4.0 x 2.5	02-B144025G
1.4 x 4.8 x 2.0		02-B144820G	
1.4 x 4.8 x 2.5		02-B144825G	
1.4 x 5.5 x 2.0		02-B145520G	
1.4 x 5.5 x 2.5		02-B145525G	
1.5 x 3.5 x 2.0		02-B153520G	
1.5 x 4.0 x 2.0		02-B154020G	
1.5 x 4.0 x 2.5		02-B154025G	
1.5 x 4.8 x 2.0		02-B154820G	
1.5 x 4.8 x 2.5		02-B154825G	
1.5 x 5.5 x 2.0		02-B155520G	
1.5 x 5.5 x 2.5		02-B155525G	

# Precision Stainless Screws

OptiSource offers a huge variety of the most popular and hard-to-find screws. Our screws are precision manufactured to the tightest tolerances and come in color-coded vials with easy-to-read descriptions. Our exclusive Stay-Tight™ thread lock coating keeps screws in place to eliminate back-out or loosening. (Screws with Stay-Tight™ include “ST” in the part number.)



## Rimless Screws

Color/Head	Description	Thread Dia.	Length	Head Dia.	Qty.	Code	Price
☒	Decorative Square Hex Trim Screw	1.4	11.0	2.0	50	44-25-14110	\$19.99
★	Star Head Trim Screw	1.2	11.0	2.3	50	44-23-12110	\$12.99
★	Star Head Trim Screw	1.4	11.0	2.3	50	44-23-14110	\$12.99
⊙	Rosette Lens Screw	1.7	9.0	2.8	50	44-03-1031	\$19.99
⊙	Rosette Lens Screw	1.7	9.0	2.8	50	44-03-1031-02	\$20.99
⊖	Lens Screw	1.2	9.4	1.9	50	44-05-111	\$9.99
⊖	Lens Screw	1.2	9.4	1.9	50	44-05-111-02	\$10.99
⊕	Lens Screw	1.2	10.0	2.5	50	33-R122510S01	\$9.99
⊕	Lens Screw	1.2	10.0	2.5	50	33-R122510G01	\$10.99
⊕	Lens Screw	1.4	10.0	2.5	50	33-R142510S02	\$9.99
⊕	Lens Screw	1.4	10.0	2.5	50	44-25-405-02-P	\$10.99
⬡	Lens Screw	1.2	10.0	2.5	50	33-R122510S03	\$11.99
⬡	Lens Screw	1.2	10.0	2.5	50	33-R122510G03	\$12.99
⬡	Lens Screw	1.4	10.0	2.5	50	33-R142510S03	\$11.99
⬡	Lens Screw	1.4	10.0	2.5	50	33-R142510G03	\$12.99
⬡	Hex Lens Screw	1.4	10.6	2.2	50	44-22-106-14	\$11.99
⬡	Hex Lens Screw	1.4	10.6	2.2	50	44-22-106-14-02	\$12.99
⊖	Lens Screw	1.4	10.5	2.5	50	44-25-405	\$9.99
⊖	Lens Screw	1.4	10.5	2.5	50	44-25-405-02	\$10.99
⊖	Lens Screw	1.16	20.0	2.5	50	44-05-179	\$10.99
⊖	Lens Screw	1.16	20.0	2.5	50	44-05-179-02	\$11.99
⊖	Lens Screw	1.27	8.8	2.5	50	44-05-190	\$10.99
⊕	Lens Screw	1.2	9.4	1.9	50	44-05-111-PM	\$9.99
⊕	Lens Screw	1.4	10.0	2.5	50	44-25-405-PM	\$9.99

## Rimless Top Hat Bushing

Inner Dia./Depth	Outer Dia.	Qty.	Code	Price
1.20 x 2.8	2.5	50	33-P1228	\$8.99
1.40 x 2.8	2.5	50	33-P1428	\$8.99
1.32 x 1.3	2.5	100	44-80-132	\$13.99
1.40 x 2.0	2.8	100	44-80-140	\$13.99



## Rimless Caps

1.20	2.5	50	33-RC2512	\$5.99
1.40	2.5	50	33-RC2514	\$5.99



## Rimless Omni-Nut Assembly

Inner Dia.	Outer Dia.	Qty.	Code	Price
1.20	2.5	50	33-OM077514	\$15.99
1.40	2.5	50	33-OM077614	\$15.99



## Reach Nuts

Silver

1.22	1.5 (5mm long)	50	44-25-161	\$22.99
1.40	1.8 (5mm long)	50	44-25-163	\$22.99

Gold

1.22	1.5 (5mm long)	50	44-25-161-02	\$23.99
1.40	1.8 (5mm long)	50	44-25-163-02	\$23.99



## Rimless Washers

Inner Dia.	Outer Dia.	Qty.	Code	Price
Transparent Plastic				
1.3	2.6	50	44-25-1326	\$6.99
1.4	2.8	50	44-25-1405	\$6.99
1.6	2.5	50	44-25-308	\$6.99
1.4	2.8	250	44-25-1405-250	\$29.99
Silver Metal				
1.3	2.6	50	33-MN1326S	\$7.99
1.4	2.8	50	33-MN1428S	\$7.99
1.5	2.8	50	33-MN1528S	\$7.99
1.4	2.5	100	44-25-133	\$17.99
Gold Metal				
1.3	2.6	50	33-MN1326G	\$8.99
1.4	2.8	50	33-MN1428G	\$8.99
1.5	2.8	50	33-MN1528G	\$8.99

## Rimless Hex Nuts

Silver				
1.2	2.2	100	44-05-101	\$13.99
1.4	2.5	50	44-25-421	\$8.99
Gold				
1.2	2.2	100	44-05-101-02	\$14.99
1.4	2.5	50	44-25-421-02	\$9.99

## Rimless Star Nuts

Silver				
1.2	2.55	50	44-25-206	\$7.99
1.4	2.50	50	44-25-208	\$7.99
Gold				
1.2	2.55	50	44-25-206-02	\$7.99
1.4	2.50	50	44-20-1425G	\$7.99

## Rimless Dome Nuts

Silver				
1.3	2.5	100	44-25-135	\$16.99
1.4	2.5	100	44-1.4CAP	\$16.99
1.4	2.5	25	44-1.4CAP-25	\$6.99
1.2	2.2	50	33-DN1222S	\$11.99
1.2	2.2	25	33-DN1222S-25	\$6.99
1.4	2.2	50	33-DN1422S	\$11.99
Gold				
1.3	2.5	100	44-25-135-02	\$18.99
1.4	2.5	100	44-1.4CAP-02	\$18.99
1.4	2.5	25	44-1.4CAP-02-25	\$6.99
1.2	2.2	50	33-DN1222G	\$11.99

## Compression Mounting Sleeves Hard Double Post

Outer Dia. x Length	Qty.	Code	Price
1.4 x 2.2	50	44-SC1-1422	\$14.99
1.4 x 4.0	50	44-SC1-1440	\$14.99
1.4 x 7.0	50	44-SC1-1470	\$14.99
1.4 x 7.0	100	44-SC1-1470-100	\$27.99
1.4 x 7.0	200	44-SC1-1470-200	\$53.99
1.5 x 2.2	50	44-SC1-1522	\$14.99
1.5 x 4.0	50	44-SC1-1540	\$14.99
1.5 x 7.0	50	44-SC1-1570	\$14.99
1.5 x 7.0	200	44-SC1-1570-200	\$53.99
1.8 x 7.0	50	44-SC1-1870	\$14.99



## Medium Double Post

1.4 x 7.0	50	33-SH1450	\$14.99
1.4 x 7.0	100	33-SH1450-100	\$27.99
1.4 x 7.0	200	33-SH1450-200	\$53.99
1.5 x 7.0	50	33-SH1550	\$14.99
1.6 x 7.0	50	33-SH1650	\$14.99

## Soft Double Post

1.4 x 7.0	50	44-SS1-1470	\$14.99
1.4 x 7.0	100	44-SS1-1470-100	\$27.99
1.4 x 7.0	200	44-SS1-1470-200	\$53.99
1.5 x 7.0	50	44-SS1-1570	\$14.99
1.5 x 7.0	100	44-SS1-1570-100	\$27.99
1.5 x 7.0	200	44-SS1-1570-200	\$53.99
1.6 x 7.0	50	44-SS1-1670	\$14.99
1.6 x 7.0	100	44-SS1-1670-100	\$27.99
1.6 x 7.0	200	44-SS1-1670-200	\$53.99

## Hard Single Post

1.4 x 2.2	50	44-SC2-1422	\$14.99
1.4 x 4.0	50	44-SC2-1440	\$14.99
1.4 x 7.0	50	44-SC2-1470	\$14.99
1.5 x 2.2	50	44-SC2-1522	\$14.99
1.5 x 4.0	50	44-SC2-1540	\$14.99
1.5 x 7.0	50	44-SC2-1570	\$14.99



## FRAME PARTS

As a quality manufacturer of frame screws, OptiSource provides the largest selection of screws that include Stay-Tight™ thread lock for free.



### Self-Aligning Spring Hinge Screws

Color	Thread x Length x Head	Qty.	Code	Price
⊖	1.2 x 3.0 x 2.0	100	44-7SAM1.2ST	\$20.99
⊖	1.2 x 3.0 x 2.0	100	44-7SAM1.2-02ST	\$22.99
⊖	1.3 x 3.0 x 2.0	100	44-7SAM1.3ST	\$20.99
⊖	1.3 x 3.0 x 2.0	100	44-7SAM1.3-02ST	\$22.99
⊖	1.4 x 3.0 x 2.0	100	44-80-030ST	\$20.99
⊖	1.4 x 3.0 x 2.0	100	44-80-030-02ST	\$22.99
⊖	1.4 x 3.5 x 2.0	100	44-80-035ST	\$20.99
⊖	1.4 x 3.5 x 2.0	100	44-80-035-02ST	\$22.99
⊖	1.4 x 4.0 x 2.0	100	44-25-105ST	\$20.99
⊖	1.4 x 4.0 x 2.0	100	44-25-105-02ST	\$22.99
⊖	1.4 x 4.8 x 2.0	100	44-80.048ST	\$20.99
⊖	1.4 x 4.8 x 2.0	100	44-80.048-02ST	\$22.99
⊖	1.4 x 6.4 x 2.0	50	44-27-205ST	\$20.99
⊖	1.4 x 9.6 x 2.5	50	44-27-423ST	\$20.99



### Self-Tapping Hinge Screws

Color	Thread x Length x Head	Qty.	Code	Price
⊖	1.3 x 9.0 x 2.5	50	44-26-605ST	\$17.99
⊖	1.3 x 9.0 x 2.5	25	44-26-605ST-25	\$8.99
⊖	1.3 x 9.0 x 2.5	50	44-26-605-02ST	\$18.99
⊖	1.4 x 9.0 x 2.5	50	44-26-606ST	\$17.99
⊖	1.4 x 9.0 x 2.5	25	44-26-606ST-25	\$9.99
⊖	1.4 x 9.0 x 2.5	50	44-26-606-02ST	\$18.99
⊖	1.5 x 9.0 x 2.5	50	44-26-607ST	\$17.99
⊖	1.5 x 9.0 x 2.5	50	44-26-607-02ST	\$18.99
⊖	1.6 x 9.0 x 2.5	50	44-26-608ST	\$17.99
⊖	1.6 x 9.0 x 2.5	50	44-26-608-02ST	\$18.99



### Self-Tapping Eyewire Screws

⊖	1.2 x 9.0 x 1.8	50	44-26-601ST	\$15.99
⊖	1.2 x 9.0 x 1.8	25	44-26-601ST-25	\$7.99
⊖	1.2 x 9.0 x 1.8	250	44-26-601ST-250	\$72.99
⊖	1.2 x 9.0 x 1.8	50	44-26-601-02ST	\$16.99
⊖	1.3 x 9.0 x 1.8	50	44-26-602ST	\$15.99
⊖	1.3 x 9.0 x 1.8	25	44-26-602ST-25	\$7.99
⊖	1.3 x 9.0 x 1.8	125	44-26-602ST-125	\$37.99
⊖	1.3 x 9.0 x 1.8	250	44-26-602ST-250	\$72.99
⊖	1.3 x 9.0 x 1.8	50	44-26-602-02ST	\$16.99
⊖	1.3 x 9.6 x 1.8	50	44-24-202	\$15.99
⊖	1.4 x 9.0 x 1.8	50	44-26-603ST	\$15.99
⊖	1.4 x 9.0 x 1.8	25	44-26-603ST-25	\$7.99
⊖	1.4 x 9.0 x 1.8	125	44-26-603ST-125	\$37.99
⊖	1.4 x 9.0 x 1.8	250	44-26-603ST-250	\$72.99
⊖	1.4 x 9.0 x 1.8	50	44-26-603-02ST	\$16.99
⊖	1.4 x 9.0 x 1.8	25	44-26-603-02ST-25	\$7.99
⊖	1.4 x 9.0 x 1.8	125	44-26-603-02ST-125	\$37.99
⊖	1.4 x 9.0 x 1.8	250	44-26-603-02ST-250	\$72.99
⊖	1.5 x 9.0 x 1.8	50	44-26-604ST	\$15.99
⊖	1.5 x 9.0 x 1.8	25	44-26-604ST-25	\$7.99
⊖	1.5 x 9.0 x 1.8	50	44-26-604-02ST	\$16.99



### Hinge Screws

⊖	1.4 x 2.9 x 2.8	100	44-25-086ST	\$14.99
⊖	1.4 x 2.9 x 2.8	100	44-25-086-02ST	\$16.99
⊖	1.4 x 3.5 x 2.5	100	44-25-051ST	\$14.99
⊖	1.4 x 3.5 x 2.5	100	44-25-051-02ST	\$16.99
⊖	1.4 x 3.6 x 2.0	100	44-25-103ST	\$14.99
⊖	1.4 x 3.6 x 2.0	100	44-25-103-02ST	\$16.99
⊖	1.4 x 4.0 x 2.0	100	44-25-078ST	\$14.99
⊖	1.4 x 4.0 x 2.0	100	44-25-078-02ST	\$16.99
⊖	1.6 x 4.4 x 2.8	100	44-25-108ST	\$14.99
⊖	1.6 x 4.4 x 2.8	100	44-25-108-02ST	\$16.99
⊖	1.5 x 3.6 x 2.5	50	44-25-091ST	\$7.99
⊖	1.5 x 4.9 x 2.8	50	44-25-095ST	\$7.99
⊖	1.27 x 4.7 x 2.5	50	44-05-100	\$2.99
⊖	1.27 x 5.5 x 2.0	50	44-05-105	\$2.99
⊖	1.37 x 5.2 x 2.0	50	44-05-153	\$2.99
⊖	1.4 x 3.55 x 2.5	50	44-25-102ST	\$7.99
⊖	1.4 x 4.0 x 2.5	50	44-25-052ST	\$7.99
⊖	1.4 x 4.0 x 2.5	50	44-25-052-02ST	\$8.99
⊖	1.4 x 4.5 x 2.5	50	44-25-053ST	\$7.99
⊖	1.4 x 5.0 x 2.5	50	44-25-054ST	\$7.99
⊖	1.6 x 4.0 x 2.5	50	44-25-090ST	\$7.99
⊖	1.6 x 5.0 x 2.5	50	44-25-106ST	\$7.99
⊖	1.6 x 3.8 x 3.0	50	44-25-109ST	\$7.99
⊖	1.6 x 5.75 x 3.0	50	44-25-409ST	\$7.99
⊖	1.7 x 5.9 x 2.8	50	44-25-075ST	\$7.99



## Sleeved Hinge Screws

- Unique plastic sleeve compresses when screwed into hinge
- Provides smooth movement and prevents backing out

Color	Thread x Length x Head	Qty.	Code	Price
⊖	1.4 x 2.8 x 1.8	50	44-26-304	\$14.99
⊖	1.4 x 3.5 x 1.8	50	44-26-305	\$14.99
⊖	1.4 x 4.0 x 1.8	50	44-26-306	\$14.99
⊖	1.4 x 3.6 x 2.0	50	44-26-309	\$14.99
⊖	1.4 x 4.0 x 2.0	50	44-26-320	\$14.99
⊖	1.4 x 4.6 x 2.0	50	44-26-321	\$14.99



## Stainless Steel Eyewire Screws

⊖	1.2 x 4.4 x 1.5	100	44-25-099ST	\$13.99
⊖	1.2 x 4.4 x 1.5	100	44-25-099-02ST	\$15.99
⊖	1.4 x 5.2 x 1.8	100	44-25-084ST	\$13.99
⊖	1.4 x 5.2 x 1.8	100	44-25-084-02ST	\$15.99
⊖	1.4 x 3.8 x 1.8	100	44-25-100ST	\$13.99
⊖	1.4 x 3.8 x 1.8	100	44-25-100-02ST	\$15.99
⊕	1.4 x 3.8 x 1.8	50	44-25-100ST-PM	\$7.99
⊖	1.4 x 4.5 x 1.8	100	44-25-101ST	\$13.99
⊖	1.4 x 4.5 x 1.8	100	44-25-101-02ST	\$15.99
⊖	1.3 x 5.2 x 2.0	50	44-25-401ST	\$7.99
⊖	1.6 x 3.5 x 2.0	50	44-25-021ST	\$7.99
⊖	1.6 x 3.5 x 2.0	50	44-25-021-02ST	\$8.99
⊖	1.6 x 4.0 x 2.0	50	44-25-022ST	\$7.99
⊖	1.6 x 4.0 x 2.0	50	44-25-022-02ST	\$8.99
⊖	1.6 x 4.5 x 2.5	50	44-25-023ST	\$7.99
⊖	1.6 x 5.0 x 2.0	50	44-25-024ST	\$7.99



## Nose Pad Screws

### Stay-Tight

⊖	1.2 x 3.2 x 1.6	100	44-25-406ST	\$13.99
⊖	1.2 x 3.2 x 1.6	100	44-25-406-02ST	\$15.99

### Standard

⊖	1.0 x 4.2 x 1.4	100	44-25-402	\$13.99
⊖	1.0 x 4.2 x 1.4	100	44-25-402-02	\$15.99
⊕	1.0 x 4.2 x 1.4	50	44-25-402-PM	\$7.99
⊖	1.1 x 5.5 x 1.7	100	44-25-115	\$13.99
⊖	1.1 x 5.5 x 1.7	100	44-25-115-02	\$15.99

### Self-Aligning

⊖	1.1 x 5.5 x 1.7	100	44-27-415	\$13.99
⊖	1.1 x 5.5 x 1.7	100	44-27-415-02	\$15.99



## Rimless Wheel

- Contains 500 of the most useful rimless frame parts
- 50 each of 10 different parts
- Screws, nuts, washers, and compression sleeves



44-RIMLESSWHEEL \$99.99

## Best Sellers Wheel

- Contains 250 of our best-selling standard screws
- 25 each of 10 different screws
- Contains both silver and gold screws
- Self-tapping, spring-hinge, and eyewire screws



44-BESTWHEEL \$49.99

## Lens Liners and Cords

- For rimless and semi-rimless grooves
- Convenient dispenser

\$9.99  
each



Pull liner out

Push to retract



"O" Shape Cord

.5mm x 65' 78-T16D-.50



"8" Shape Liner

.39mm x 35' 78-T16E-.39  
.51mm x 35' 78-T16E-.51  
.55mm x 35' 78-T16E-.55

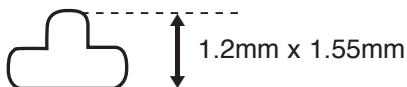

"T" Shape Liner

1.2mm x 16' 78-T16F-1.2  
1.55mm x 16' 78-T16F-1.55



"U" Shape Interliner

1.2mm x 16' 78-T16G-1.2

## Colored 'O' Shape Liner

\$9.99  
each

- Used with semi-rimless frames to complement frame color
- Convenient dispenser

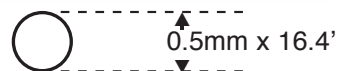

Black	44-16-1
Green	44-16-2
Blue	44-16-3
Purple	44-16-4
Yellow	44-16-5
Red	44-16-6
Pink	44-16-7
Light Brown	44-16-8
Brown	44-16-9

## Lens Interliner

- Fills gaps in eyewires
- .25mm x 10'



32-INTERLINER \$5.99



# Frame Parts Drawer System

**\$9.99**  
each drawer



Our modular design allows for the greatest flexibility for frame parts storage. Neatly store standard screws, Snapit™ screws, nose pads, temple-ends, and other frame parts in a compact footprint. Three different drawer designs are interchangeable and stackable to offer the greatest variety for your storage and organizing needs.



- Sturdy, durable plastic construction
- Stackable, interchangeable drawer designs
- Each drawer measures 16.5cm (W) x 18.5cm (D)
- Screw drawers are 4cm (H) and nose pad drawers are 8cm (H)

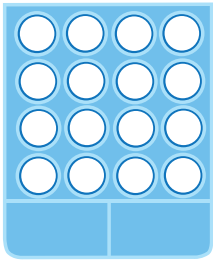

44-650-1  
Drawer for Screw Vials

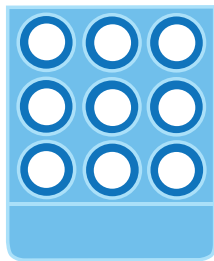

44-650-2  
Drawer for Nose Pad Vials

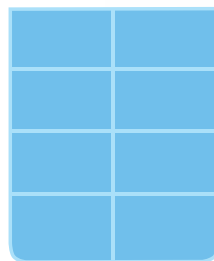

44-650-3  
Drawer for Temple Tips

# Heat Shrink Temple Covers

Kit contains an assortment of black, clear, brown, and gray shrink tubing in two convenient sizes (1/8" and 3/16" x 4"). Each color and size is separated by a labeled compartment, while the hard plastic case provides easy storage.

- Four colors, 80 pieces total
- Shrinks to 1/3 of its original size
- For use with Hot Air Frame Warmers



**\$3.99**  
per bag

Packaged 10 Pieces Per Bag



Kit  
99-290-1 \$37.99

### 1/8" x 4" Refills

Black	99-290-2
Clear	99-290-3
Brown	99-290-4
Gray	99-290-5

### 3/16" x 4" Refills

Black	99-290-6
Clear	99-290-7
Brown	99-290-8
Gray	99-290-9

# Nose Pads

Fully Expanded Nose Pad Offering – The Best Fit for Every Job



Snap-In



Screw-In

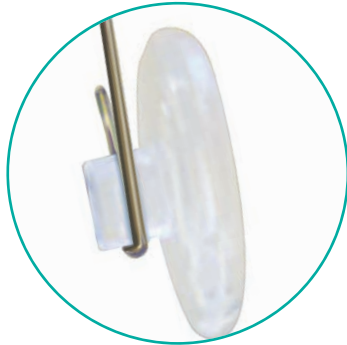

Slide-In



Stick-On

- Three nose pad materials – silicone, plastic, and polycarbonate
- Ultra-Slim polycarbonate nose pads are the thinnest and lightest in the industry
- Every nose pad size – from 9mm to 19mm
- New strap bridge and screw-to-frame bridge styles

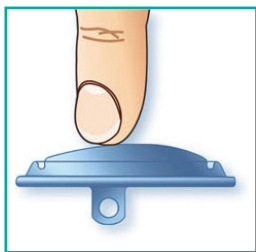

## BioFeel® Gel-Cushioned Nose Pad

World-patented BioFeel nose pads are the most versatile, comfortable, and functional nose pads available. Why do walk-in nose pad replacements for free? Introduce customers to BioFeel and turn repairs into profits! Your customers will thank you. These gel-cushioned hypoallergenic pads come in a universal size and shape to minimize inventory. Once you try these problem-solver nose pads, you'll never go back to standard pads.

**\$2.99**  
per pair

Packaged  
5 Pair  
Per Bag

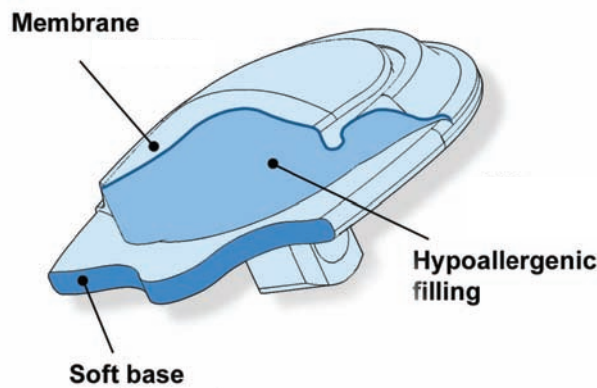
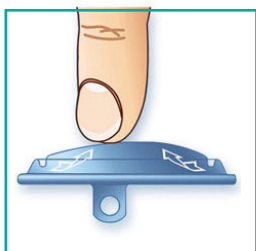
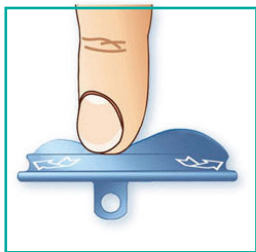

12.6mm Snap	33-BIOFEELSNAP
12.6mm Screw	33-BIOFEELSCREW

### Silicone Symmetrical Slide-In

69¢  
per pair

Packaged 25 Pair Per Vial

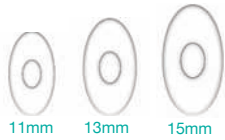

Oval

11mm	33-OS11SPI
13mm	33-OS13SPI
15mm	33-OS15SPI

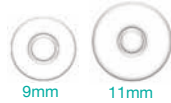

Round

9mm	33-OS9RSPI
11mm	33-OS11RSPI

### Silicone Symmetrical with Metal Insert

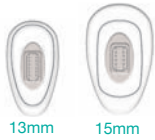

Silver Snap/Tear Drop

13mm	33-OS13SN-S
15mm	33-OS15SN-S



Silver Screw/Tear Drop

13mm	33-OS13SC-S
15mm	33-OS15SC-S

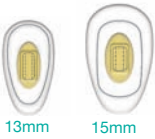

Gold Snap/Tear Drop

13mm	33-OS13SN-G
15mm	33-OS15SN-G



Gold Screw/Tear Drop

13mm	33-OS13SC-G
15mm	33-OS15SC-G

### Silicone Symmetrical

69¢  
per pair

Packaged 25 Pair Per Vial



Snap/Round

9mm	33-OS9SN
11mm	33-OS11RSN



Screw/Round

9mm	33-OS9SC
11mm	33-OS11RSC

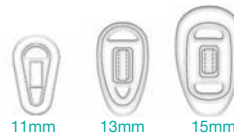

11mm 13mm 15mm



11mm 13mm 15mm

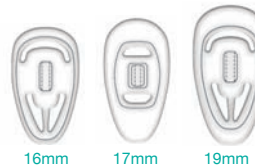

16mm 17mm 19mm

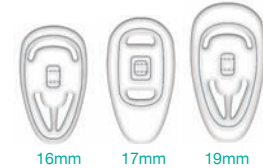

16mm 17mm 19mm

Snap/Tear Drop

11mm	33-OS11SN
13mm	33-OS13SN
15mm	33-OS15SN
16mm	33-OS16SN
17mm	33-OS17SN
19mm	33-OS19SN

Screw/Tear Drop

11mm	33-OS11SC
13mm	33-OS13SC
15mm	33-OS15SC
16mm	33-OS16SC
17mm	33-OS17SC
19mm	33-OS19SC

### Silicone D-Shape

69¢  
per pair

Packaged 25 Pair Per Vial



13mm 15mm



13mm 15mm



17mm 19mm



17mm 19mm

Snap

13mm	33-OS13DSN
15mm	33-OS15DSN
17mm	33-OS17DSN
19mm	33-OS19DSN

Screw

13mm	33-OS13DSC
15mm	33-OS15DSC
17mm	33-OS17DSC
19mm	33-OS19DSC

### Silicone Oval

69¢  
per pair

Packaged 25 Pair Per Vial

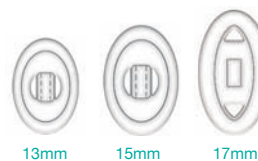

13mm 15mm 17mm

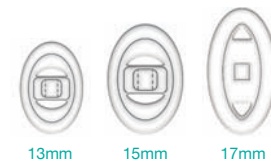

13mm 15mm 17mm

Snap/Oval

13mm	33-OS13OVSN
15mm	33-OS15OVSN
17mm	33-OS17OVSN

Screw/Oval

13mm	33-OS13OVSC
15mm	33-OS15OVSC
17mm	33-OS17OVSC

# FRAME PARTS

## Plastic Symmetrical

**69¢**  
per pair

Packaged 25 Pair Per Vial



9mm

Snap/Round

9mm 33-OS9PN



9mm

Screw/Round

9mm 33-OS9PC

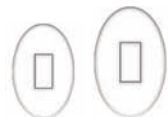

13mm

15mm

Snap/Oval

13mm 33-OS13OVPN

15mm 33-OS15OVPN

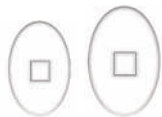

13mm

15mm

Screw/Oval

13mm 33-OS13OVPC

15mm 33-OS15OVPC



13mm

15mm

17mm

Snap/Tear Drop

13mm 33-OS13PN

15mm 33-OS15PN

17mm 33-OS17PN



13mm

15mm

17mm

Screw/Tear Drop

13mm 33-OS13PC

15mm 33-OS15PC

17mm 33-OS17PC

## Plastic D-Shape



13mm

15mm

17mm

Snap

13mm 33-OS13DPN

15mm 33-OS15DPN

17mm 33-OS17DPN



13mm

15mm

17mm

Screw

13mm 33-OS13DPC

15mm 33-OS15DPC

17mm 33-OS17DPC

## Plastic Symmetrical with Metal Insert



13mm

15mm

Silver Snap/Tear Drop

13mm 33-OS13PN-S

15mm 33-OS15PN-S



13mm

15mm

Silver Screw/Tear Drop

13mm 33-OS13PC-S

15mm 33-OS15PC-S



13mm

15mm

Gold Snap/Tear Drop

13mm 33-OS13PN-G

15mm 33-OS15PN-G



13mm

15mm

Gold Screw/Tear Drop

13mm 33-OS13PC-G

15mm 33-OS15PC-G

## Polycarbonate Superslim

**69¢**  
per pair

Packaged 25 Pair Per Vial



9mm

Screw/Round

9mm 33-OS9RCPOLY



10mm

Snap/D-Shape

10mm 33-OS10DNPOLY



10mm

13mm

Screw/D-Shape

10mm 33-OS10DCPOLY

13mm 33-OS13DCPOLY



12mm

Snap/Oval

12mm 33-OS12OVNPOLY



12mm

Screw/Oval

12mm 33-OS12OVCPOLY



12mm

Slide-In/Oval

12mm 33-OS12OVPIPOLY



13mm

Snap/Tear Drop

13mm 33-OS13NPOLY



13mm

Screw/Tear Drop

13mm 33-OS13CPOLY

## Crimp-On Symmetrical

**\$1.45**  
per pair

Packaged 25 Pair Per Vial



15mm

Crimp-On/Tear Drop

15mm 33-OS15RB



### Silicone Strap Bridge

**\$2.99**  
each

Packaged 5 Pair Per Vial



21.5 x 15mm



21.5 x 15mm



30.5 x 14mm



30.5 x 14mm



36.8 x 20mm



36.8 x 20mm

#### Snap

21.5mm	33-OS21.5SN
30.5mm	33-OS30.5SN
36.8mm	33-OS36.5SN

#### Screw

21.5mm	33-OS21.5SC
30.5mm	33-OS30.5SC
36.8mm	33-OS36.5SC

### Silicone Screw-to-Frame Bridges

**\$1.99**  
each

Packaged 5 Pair Per Vial



14 x 18mm



14 x 18mm



15 x 24mm



15 x 24mm



17 x 30mm



17 x 30mm

#### Silver

14mm	33-OS14BRCS
15mm	33-OS15BRCS
17mm	33-OS17BRCS

#### Gold

14mm	33-OS14BRCG
15mm	33-OS15BRCG
17mm	33-OS17BRCG

### Stick-On Nose Pads

**99¢**  
per pair

Packaged 5 Pair Per Bag



16mm 16mm



16mm 16mm



15mm

#### Foam/Oblong

Peach	16 x 7mm	33-B102P
Coffee	16 x 7mm	33-B102C

#### Foam/Tear Drop

Peach	16 x 8mm	33-B202P
Coffee	16 x 8mm	33-B202C

#### Silicone

15mm	33-OS15SO
------	-----------

# Temple Tips

\$5.99  
8 pair

Temple Tips Add a Protective Barrier Against Irritation for Sensitive Skin

## Standard Plastic

Our most popular replacement temple covers

- 2.0mm core diameter



Clear	99-OSTT108/2000
Black	99-OSTT108/0000
Tortoise	99-OSTT108/6000
Brown	99-OSTT108/1000
Gray	99-OSTT108/5000

## Plastic Rectangular Core

For use with rectangular temple cores

- 1.2 x 2.6mm core diameter



Black	99-OSTT109/0000
Brown	99-OSTT109/1000

## Silicone Over Plastic

Soft material conforms to your head and bends to your needs

- 1.4mm core diameter



Clear	99-OSTT107/2000
Black	99-OSTT107/0000
Tortoise	99-OSTT107/6000
Brown	99-OSTT107/1000
Gray	99-OSTT107/5000

To select the correct size replacement temple tip:

1. Straighten the temple
2. Heat and remove the temple tip
3. Measure the core wire diameter with a caliper
4. Choose from our extensive collection

## Flared Plastic

Available in a variety of colors to match every frame

- 1.6mm core diameter



Clear	99-OSTT106/2000
Black	99-OSTT106/0000
Tortoise	99-OSTT106/6000
Brown	99-OSTT106/1000
Gray	99-OSTT106/5000

## Hard Plastic Protective

Adds a protective barrier from irritation for sensitive skin

- 1.6mm core diameter



Black	99-OSTT124/0000
Brown	99-OSTT124/1000

## Ultra-Thin Plastic

For today's popular metal frames

- 1.1mm core diameter



Clear	99-OSTT86/2000
Black	99-OSTT86/0000
Tortoise	99-OSTT86/3000
Brown	99-OSTT86/1000

# Ear-Lock Temple Ends

\$14.99  
5 pair

Provide your patients with a new solution for eyewear slippage with our removable silicone temple locks.

- Eliminate the need for cable temple ends
- Available in 6 popular colors
- Overall length: 37mm
- Core diameter: 5.8 x 2mm
- Material: Silicone



Yellow	33-ELTE-YL
Pink	33-ELTE-PK
Black	33-ELTE-BK
Blue	33-ELTE-BL
White	33-ELTE-WH
Brown	33-ELTE-BR

# Foam Temple Pads

99¢  
per pair

Soft, self-adhesive foam temple pad reduces slipping and provides a comfortable cushion behind the ear.

Packaged 4 Pair Per Pack



Foam/Oblong  
19 x 9.5mm

Peach	33-B103P
Coffee	33-B103C



Foam/Tear Drop  
19 x 8mm

Peach	33-B203P
Coffee	33-B203C

# Acetate Temple Tips

\$5.99  
2 Pair

- Premium handmade acetate
- Available in 17 popular shapes and colors
- 1.4mm core diameter



Red 99-282-1



Pink 99-282-2



Caramel 99-282-3



Teal 99-282-4



Green 99-282-5



White 99-282-6



Yellow Tortoise 99-282-7



Pink Tortoise 99-282-8



Purple 99-282-9



Navy 99-282-10



Pink Duotone 99-282-11



Ivory 99-282-12



Brown 99-282-13



Grey 99-282-14



Steel Blue 99-282-15



Black 99-282-16



Steel Blue 99-282-17

CHEMISTRY

MACHINERY

EDGING

SURFACING

TOOLS

FRAME PARTS

EXAM SUPPLIES

ACCESSORIES

LENS CLEANERS

# FRAME PARTS

## Frame Tags

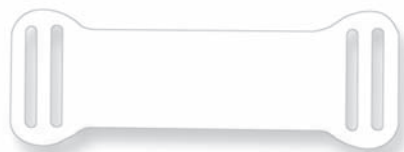

Non-Slip Plastic Op-Tags

- White
- 1 1/16" x 2"
- 1,000 count

75-SO830 \$98.50



Paper Direct Thermal Tags

- White
- 1 1/8" x 1 3/16"
- 1,000 count

75-DT390 \$33.75



Simulated Security Tags

- Silver (S) or Gold (G)
- 5/8" x 1 61/64"
- 1,000 count

75-P409-S \$81.30  
75-P409-G \$81.30



Non-Slip Plastic Op-Tags

- Tan
- 2 5/16" X 15/16"
- 1,000 count

75-SO833 \$102.85



Plastic Slip-On Op-Tags

- Light Blue
- 11/16" X 1 13/32"
- 1,000 count

75-SO808 \$81.85



Blank Static Vinyl Labels

- White (W) or Clear (C)
- 3/8" X 5/8"
- 1,000 count

75-SV151-W \$55.20  
75-SV151-C \$55.20



Left/Right Contact Lens Indication Labels

- 3/4" x 7/16"
- 1,000 count

75-P289LRW \$69.80

## Rhinestone Kit

Add rhinestones to decorate and personalize customer lenses. Kit comes complete with everything you need:

- 18 types of stones-100 each
- Permanent cement
- Hand drill



Amethyst



Sapphire



Topaz

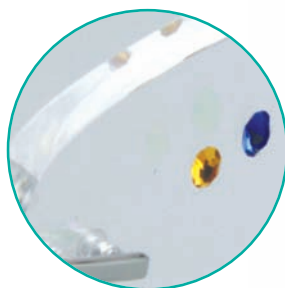

Drill the hole, inject the cement, and insert the stone



78-TA70 \$99.99





# EXAM SUPPLIES

Precision Vision

Providing perfect corrective vision starts with a comprehensive eye exam. OptiSource offers the manual tools for during and after the exam. The quality of our glass trial lenses, trial frames, charts, and more are all selected with the goal of providing Precision Vision. You can also rely on us for post-surgery temporary sunglasses, AMD supplementation, eye patches, and equipment bulbs.

## Slit Lamp Camera Phone Adapter

Universal Camera Phone Adapter  
for all Conventional Slit Lamps

If your Slit Lamp does not take digital pictures... Introducing an inexpensive solution that allows eyecare professionals to use their smartphones to upload, store, and share their slit lamp clinical findings.

- Fits all conventional slit lamps
- Fits all smartphones



Easy Set up onto Slit Lamp



User-Friendly

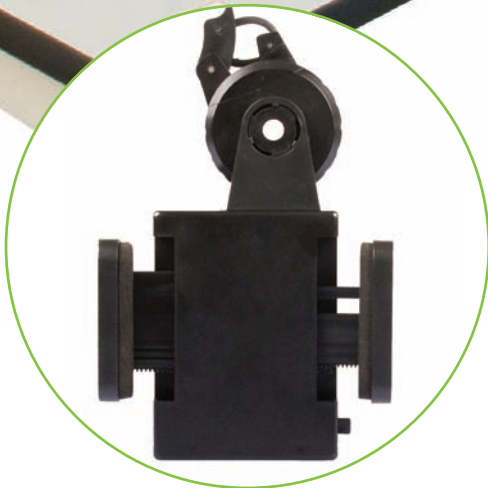

Images Stored and Shared  
on Your Smart Phone

32-SLCA

\$199.99



## Deluxe Digital Pupilometer

This classic design includes all of today's technology to make it our best pupilometer ever. The Calibration Reference Marks allow for recalibration if the unit is dropped or mishandled to ensure precise measurements. The durable finish will not chip or fade and is washable. The adjustable LED light source makes reading easy and allows for extra-long battery life.

- Auto shut-off feature is adjustable between 30 seconds and 3 minutes
- Range of focal distance from 30cm to infinity
- Range of measurement from 45 to 82mm binocular PD, 22.5 to 41mm monocular PD
- Graduations in .5mm steps

Power: Uses two AA batteries (Not included)  
Weight: 1.5 pounds  
Dimensions (W x H x D): 6.5" x 2.5" x 8.75"

	32-PDMETERDLUX	\$399.99
Bumper		
Black	32-PDBUMPERBLK	\$14.99
Gray	32-PDBUMPERGRY	\$14.99
White	32-PDBUMPERWHT	\$14.99



### Optional Protective Silicone Bumper

Removable protective bumper available in three colors: black, gray, and white.

## Standard Digital Pupilometer

This quality digital pupilometer's ergonomic design will give you years of reliable, accurate service. It features a large, easy to read LED display that calculates individual and total PD, smooth slider switches and an illuminated focal point.

- Ergo design is comfortable and functional
- Range of focal distance from 30cm to infinity
- Range of measurement from 48 to 77mm binocular PD, 24 to 38.5mm monocular PD
- Graduations in .5mm steps

Power: Uses four AA batteries (Not included)  
Weight: 1.5 pounds  
Dimensions (W x H x D): 6" x 2" x 8.75"

32-PDMETERSTND	\$349.99
----------------	----------



## Mini PD Meter

### Easy-to-Use Mini PD Meter for Fast Measurements

- High contrast digital display
- Shows both monocular and binocular PD measurement
- Automatically turns off when placed on a flat surface
- Measuring range: 45-82mm

Power: Uses one 23A 12 Volt battery (Not included)  
Weight: 0.5 pounds  
Dimensions (W x H x D): 8.5" x 4.75" x 1.75"

32-PDMETERMINI	\$149.99
----------------	----------





## Colorful Eye Patches

**\$19.99**  
6 pack

In addition to the bright, colorful, breathable material, these patches easily remain in place around the head using a flexible and comfortable elastic headband. Available in junior or adult sizes.

### Adult

Black	78 x 60mm	31-OSPABLK
Primary Colors	78 x 60mm	31-OSPAPRI
Pastel Colors	80 x 60mm	31-OSPAPAS

### Junior

Black	65 x 52mm	31-OSPJBLK
Primary Colors	65 x 52mm	31-OSPJPRI
Pastel Colors	70 x 50mm	31-OSPJPAS



Black Patch



Primary Colors



Pastel Colors



## Eyeglass Patches

**\$7.99**  
each



17-GIGPBU



17-GIGPWH

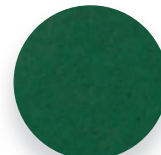

17-GIGPDG



17-GIGPBK



17-GIGPNY

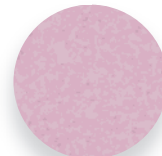

17-GIGPPK

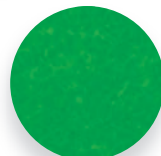

17-GIGPLG

Blue	17-GIGPBU
White	17-GIGPWH
Dark Green	17-GIGPDG
Black	17-GIGPBK
Navy Blue	17-GIGPNY
Pink	17-GIGPPK
Light Green	17-GIGPLG



# Children's Eye Patches

\$7.99  
each

## Girl's Prints

- Fun designs for girls of all ages
- 70 x 55mm



Candy Hearts



Pink Hearts



Girl's Stuff



Fairies



Ladybugs



Watermelon



Daisies



Butterfly



Rainbow



Cupcakes

Candy Hearts	17-GICANDYHRTEP
Pink Hearts	17-GIHEART2EP
Girl's Stuff	17-GIGIRLSTUFFEP
Fairies	17-GIFAIRYEP
Ladybugs	17-GIBUGEP2YLW
Watermelon	17-GIWTMLNEP
Daisies	17-GIDAISIESEP
Butterfly	17-GIBTFLYEP
Rainbow	17-GIRNNBWEP
Cupcakes	17-GICUPCKEP

## Boy's Prints

- Sporty designs for boys young and old
- 70 x 55mm



Skulls



Music Notes



Vehicles



Dark Camo



Sports



Dinosaurs



Big Skulls



Paw Print



Fire Tiger



Sharks

Skulls	17-GISKULLEP
Music Notes	17-GIMUSICEP
Vehicles	17-GICARSEP
Dark Camo	17-GICAMOEP
Sports	17-GISPORTSEP
Dinosaurs	17-GIDINOEP
Big Skulls	17-GIBIGSKLEP
Paw Print	17-GIPAWEP
Fire Tiger	17-GIFIRETGREP
Sharks	17-GISHRKEP

NOTE: Fabric designs vary and are subject to change

# Post-Mydriatic Sunglasses

## Roll-Up Lens

- 100 per bag



59-E250-808 \$54.99

## Paper Temple Sunglasses

- 100 per bag



Pediatric 59-E250-810 \$49.99  
 Adult 59-E250-805 \$44.99

## Slip-In Post Myds

- Slips in behind glasses and rests on temples
- 250 per bag



Pediatric 66-151S \$89.99  
 Adult 66-151R \$95.99

## Hook-On Sunglasses

- Slips in behind glasses and hooks on the top of frame
- Large size 54mm
- Small size 45mm



Large 66-105L  
 Small 66-105R

\$2.99  
 each

## Plastic Medical Eye Shield

- Occludes and shields the eye
- 78 x 50 mm (3.1" x 2")
- Package of 12



11-BU130B \$35.99

## Chin Rest Papers

\$9.99  
 per 500

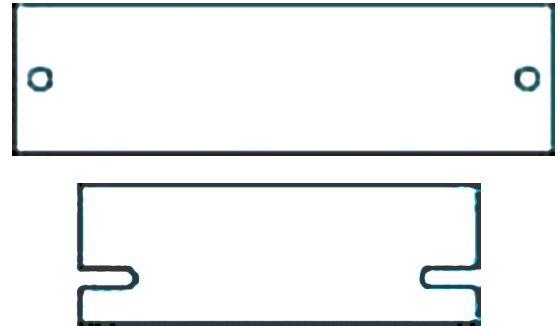

Topcon	07-AJZ7902
Haag Streit	07-AJZ7903
Zeiss, Humphrey 500-600 Series	07-AJZ8029
Nikon 500-600 Series	07-AJZ8014
Burlon, Canon, Cooper Vision / Dicon	07-AJH6202
Mentor AD Optimed	07-AJZ8039
B&L, Mentor, Nidek	07-AJZ7900
Marco Chin	07-AJZ7901

## Plastic Occluder

- 9.5" long
- 2.25" diameter



61-1266 \$9.99

## Comfort Eye Patch

\$5.99 each



Allows eyelid to freely move without pressure from the eye patch.

- Vinyl opaque shield front with comfortable foam edging
- Adjustable elastic band will fit either eye

Black		White	
Large	66-147LB	Large	66-147LW
Small	66-147SB	Small	66-147SW

Small size: 40 x 60mm  
Large size: 50 x 70mm

## Clip-On Moisture Chamber

\$8.99 each



### Left Eye

Small	66-144SL
Medium	66-144ML
Large	66-144LL
X-Large	66-144XLL

### Right Eye

Small	66-144SR
Medium	66-144MR
Large	66-144LR
X-Large	66-144XLR

This clear vinyl shield is designed with two attachment options to fit all frames. Soft white foam edging gently hugs facial contours.

- Ideal for dry-eye conditions

### Size Reference

Small:	35x55mm	Fits 34-38 Lenses
Medium:	40x60mm	Fits 38-42 Lenses
Large:	43x65mm	Fits 42-48 Lenses
X-Large:	47x70mm	Fits 48-56 Lenses

## Nose Guard



Suspends eyeglasses off the nose to relieve pressure. Perfect for post nasal surgery to eliminate undue pressure from nasal area.

- One size fits all

66-146 \$10.99



## Moisture Chamber with Elastic Head Band

\$9.99 each



Clear vinyl shield with elastic head band includes a soft white foam edging that gently hugs facial contours.

- Ideal for dry-eye conditions
- Fits right or left eye

### Size Reference

Small:	35x55mm	Fits 34-38 Lenses
Large:	50x70mm	Fits 42-48 Lenses

Large	66-144LB
Small	66-144SB

## Double Pin-Hole Occluder

\$12.99 each

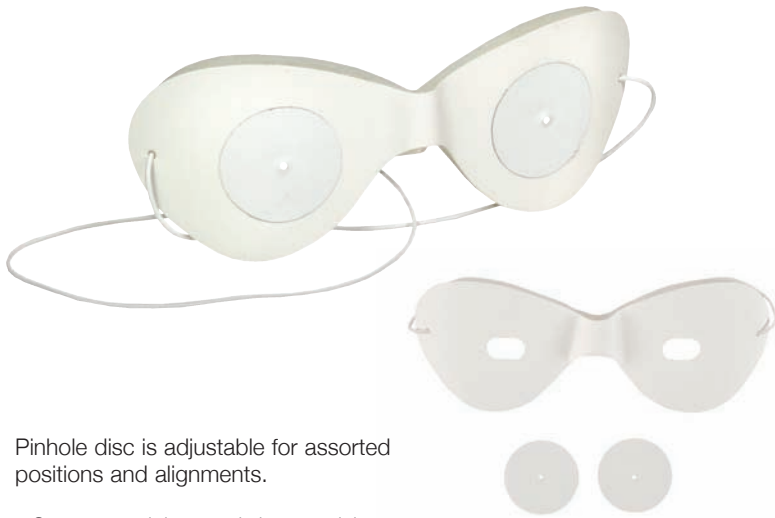

Pinhole disc is adjustable for assorted positions and alignments.

- Soft foam edging gently hugs facial contours
- Adaptable elastic band to fit all head sizes

Small	66-148S
Large	66-148L

Small: 138 x 48mm  
Large: 143 x 54mm

## Eye Protection for Infant Phototherapy



Provides convenient non-sterile protection for the eyes of infants undergoing phototherapy. Soft vinyl shield section with cotton backing directly covers the eye, protecting against penetrating rays.

- Velcro fasteners
- Adjustable elastic headband fits most infant head sizes

66-138	\$4.99
--------	--------

## Suction Cup Occluder

\$7.99 each



Suction cup attaches to the lens while soft sponge edging gently hugs facial contours.

- Blocks out vision
- Fits right or left eye

Small	66-141S
Medium	66-141M
Large	66-141L

## Single Pin-Hole Occluder

\$9.99 each



Adjustable midsection pinhole disc for assorted positions and proper alignment.

- Clip-on spring makes attachment to frame easy and secure
- Soft foam edging gently hugs facial contours
- Available in a variety of sizes for all frames

### Left Eye

Small	66-145SL
Medium	66-145ML
Large	66-145LL
X-Large	66-145XLL

### Right Eye

Small	66-145SR
Medium	66-145MR
Large	66-145LR
X-Large	66-145XLR

### Size Reference

Small:	35x55mm	Fits 34-38 Lenses
Medium:	40x60mm	Fits 38-42 Lenses
Large:	43x65mm	Fits 42-48 Lenses
X-Large:	47x70mm	Fits 48-56 Lenses

## Blackout Occluder

\$7.99 each

Clip-on spring makes attachment to frame easy and secure. Soft sponge gently hugs facial contours.

- Completely blocks out vision
- Available in a variety of sizes for all frames



### Left Eye

Small	66-143SL
Medium	66-143ML
Large	66-143LL
X-Large	66-143XLL

### Right Eye

Small	66-143SR
Medium	66-143MR
Large	66-143LR
X-Large	66-143XLR



## Trial Lens Set



Glass Trial Lens Set

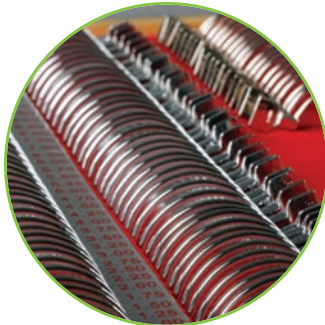

Metal Rims



Fits Most Trial Frames



This complete set of 266 trial lenses includes spheres from +/- .25D to 20.00D, cylinders from +/- .25 D to 6.00D, prism from .50 D to 10.00D, and 10 auxiliary lenses.

- Lenses made of highest quality ophthalmic glass
- Rims constructed of durable metal to ensure longevity of lens set
- Durable aluminum case

32-TRIALLENSSET \$469.99

## Universal Trial Frame



- One size fits all
- No sharp points
- Holds up to 4 pairs of lenses

32-TRIALFRM \$99.99

# Eye Charts

## Tumbling E Chart

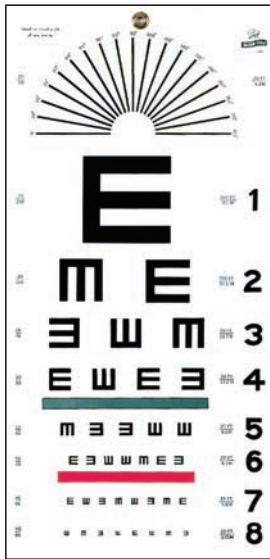

- Measures 20/200 to 20/10
- Size: 11" x 22 1/2"

61-1241 \$24.99

## Snellen Eye Chart 20'

- Measures 20/200 to 20/10
- Translucent to work in light boxes
- Size: 11" x 22 1/2"

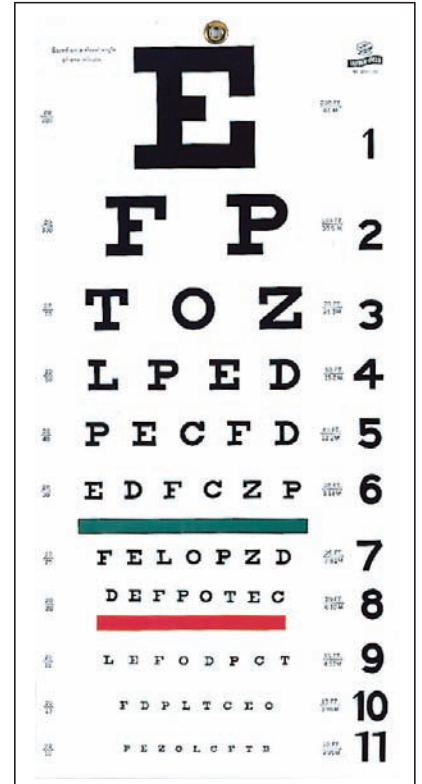

61-1240 \$24.99

## Eye Chart 10'



- Measures 10/100 to 10/8
- Size: 9" x 14"

11-BBC1264 \$19.99

## Rosenbaum Pocket Vision Screener



- Measures 20/800 to 20/20 at 14 inches
- Size: 3 1/2" x 6 3/8"

11-BRPS \$24.99

## Pediatric Large Vision Test

- Measures 20/200 to 20/10
- Size: 11" x 22 1/2"

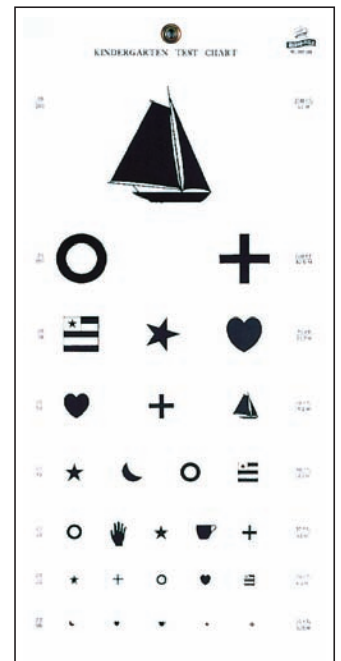

61-1243 \$24.99

## Near Vision Test Card



- Front: Eye Chart
- Back: Newspaper article
- Size: 5 3/8" x 8"

11-BODNVC \$12.99

## Ishihara Book

Simple and accurate method for discovering congenital color blindness and red-green blindness, each in two forms, complete and incomplete. Makes use of the peculiarity that in red-green blindness, blue and yellow appear remarkably bright compared with red and green.

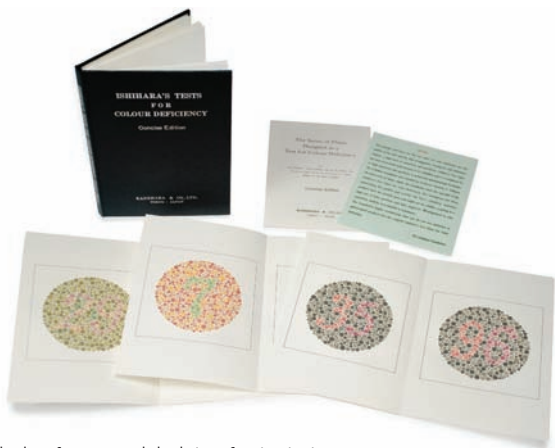

- Includes four special plates for tests to determine the kind and degree of defect in color vision
- Color plates encased in specially designed album-type books for ease of handling
- 14 plate book

61-1254 \$189.99

## Horizontal Prism Bar

Prism bar includes diopters:  
1, 2, 4, 8, 12, 14, 16, 18, 20, 25, 30, 35, and 40.

- Case included

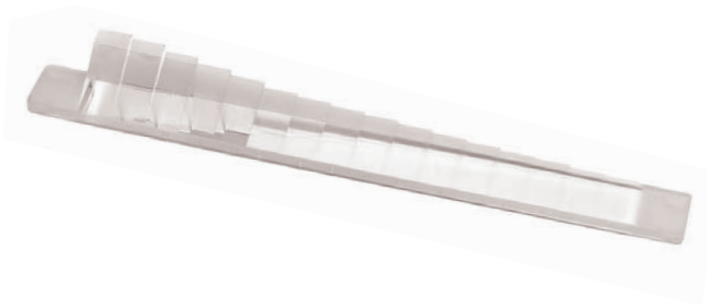

32-PRISMBAR-H \$179.99

## Contact Lens Handling

### DMV® Ultra™

- Inserts and removes Gas Permeable and Hard lenses

72-DMVULTRA \$2.49



### DMV® 45™

- Insertion and removal done at a 45° angle

72-DMV45 \$2.39



### DMV® Classic™

- The best option for Ortho-K lenses

72-DMVCLASSIC \$2.29



### DMV® MagicTouch™

- Hollow shaft provides optional suction for increased control

72-DMVMT \$2.49



### DMV® Scleral Cup™

- Securely grasps the contact lens or prosthetic eye for insertion and removal

72-DMVSC \$3.49



### DMV® Magna Mirror™

- Provides an excellent view of the eye to assist with contact lens insertion and removal

72-DMVMM \$14.99





## Clip-On Night Light

This featherweight light easily attaches to any eyewear frame and provides a bright, uniform light for any type of activity. The built-in swivel function allows adjustment of light in any direction.

- Great for reading, repair projects, or any low light activity
- Long lasting LR41 batteries included
- Makes a great hands-free exam light for ODs



99-240-1 \$9.99

## Eyeglass Light

Mounts easily on either right or left temple. Adjustable arm projects bright LED light.

- Long-lasting replaceable lithium batteries included
- Great for reading in bed, on a plane, map reading, and more



99-EYEGLASSLIGHT \$13.99

## Disposable Clip Penlights

These pen lights are economical, lightweight, and have a pupil gauge printed on them.

- Professional examination light
- Comes with pupil gauge



61-4062 \$13.99





## MacuHealth LMZ<sup>3</sup>

### Patented Supplement Formula Offers New Promise for AMD Patients

Age-Related Macular Degeneration (AMD) is a chronic condition that causes central vision loss. It affects millions of Americans. In fact, it is a leading cause of blindness in people 60 and older. Early detection and prevention have been shown to be the best way to prevent vision loss with AMD patients.

- Proven to restore critical macular pigment to normal levels
- Helps reduce the risk of Macular Degeneration
- Formula combines powerful antioxidants:  
10mg Lutein, 10mg Meso-Zeaxanthin, and 2mg Zeaxanthin
- Each bottle contains 90 one-a-day capsules
- LMZ3 is a unique triple carotenoid eye supplement,  
researched by expert scientists and endorsed by leading eye  
care professionals worldwide
- Case of 24

12-MACU24      \$1,007.76



Macular Degeneration Education  
and Resource Center

# Pharmaceuticals



## Paremyd 15ml

Tropicamide 0.25%,  
Hydroxyamphetamine Bromide 0.1%



40-JO750113

## Proparacaine 0.5% 15ml



40-JO750012

## Tropicamide

0.5% 15ml  
1.0% 15ml



40-JO743101

40-JO752812

## Fluorox

Fluorescein Sodium 0.25%,  
Benoxinate 0.4%



40-JO750722

## Fluorocaine 5ml

Fluorescein Sodium 0.25%,  
Proparacaine HCL 0.5%

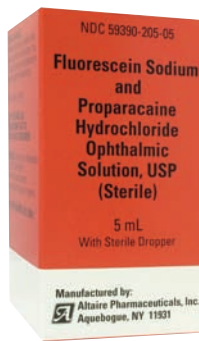

40-JO750721

## TetraVisc 0.5% 5ml



40-JO743468

## Indocyanine Green

25mg with Diluent Vial, 6/box



40-JO1001

## Tetracaine 0.5% 15ml



40-JO743151

## Phenylephrine

2.5% 15ml Neo-Syneprine  
10% 5ml Neo-Syneprine



40-JO753015

40-JO743110



Cyclopentolate 1% 15ml  
AK-Pentolate



40-JO750114

Fluorescein Sodium  
Ophthalmic Strips 300/box



40-JO743167

Lissamine Green Strips  
100/box



40-JO743140

Erythromycin 0.5% 3.5g  
Ilotycin Ointment



40-JO744115

Homatropine 5% 5ml



40-JO743115

Neomycin, Polymyxin B,  
Dexamethasone  
3.5g



40-JO744136

Kenalog  
40mg per 1ml



40-JO744295

Lidocaine HCl  
4% 50ml Topical



40-JO746417

Ofloxacin  
Ophthalmic Solution 0.3% 5ml



40-JO743395



Sodium Chloride  
5.0% 15ml



40-JO745102

Polymyxin B Sulfate  
Trimethoprim 10ml



40-JO744248

Atropine Sulfate 1% 5ml



40-JO743140

PDI Sani-Cloth® Plus

- Germicidal disposable cloths
- Effective against 16 microorganisms
- Contact time: 3 minutes
- 160 wipes per can



99-PDIQ89072 \$13.49

PDI Super Sani-Cloth®

- Germicidal disposable wipes
- Effective against 30 microorganisms
- Contact time: 2 minutes
- 160 wipes per can



99-PDIQ55172 \$13.49

Alcohol Pads

- Saturated with 70% isopropyl alcohol
- 2 Ply
- 1 1/4" x 2 5/8" size
- 200 per box



99-ALCOHOLPAD \$4.99





## Bulbs

### Ophthalmic Replacement Bulbs For All Equipment

We will cross-reference and identify lamps for all applications. Simply provide your equipment's make, model, bulb base type, and bulb power.

\*All bulbs are priced per unit.

### Chart Projectors

MFPN	Manufacturer	Volts / Watts / Amps	Application	Code	Price
CAX130V	GE	130V 50W	AO/Reichert 11082, 1215, 1217	24-BT02816	\$8.99
1096	GE	6V 4.5A	AO/Reichert 11800,11805,11820, 11825,12060, 12065	24-BT08168	\$37.99
7388	Philips	6V 20W	AO/Reichert 11075 Long Life, 11083, 778, Chart Projector II Selectra POC, Woodlyn 31500, H-31200, Eye Chart Marco CP-670, Nikon 89500 Short Life, NP3, NP35, NP3s Topcon Equivalent 4244020030, Topcon Main ACP-5D, ACP-6D, ACP-6R, ACP-6S	24-BT00986	\$15.99
64261	Osram	12V 30W	ACP-7M, ACP-R, ACP-7S	24-BT00865	\$34.99
50T424DC	Dr Fisher	24V 50W	BT Mitey Lite, Transformer Needed	24-BT00677	\$44.99
CAX130VHAL	Ushio	130V 50W	AO/Reichert 11082, 1215, 1217	24-BT01166	\$33.99
ESBFHE	Wiko	6V 30W	Various	24-BT01508	\$7.99

### Slit Lamps

MFPN	Manufacturer	Volts / Watts / Amps	Application	Code	Price
			Burton 1000, 800, 850	24-BT02759	\$22.99
6605	Philips	6V	B&L 6V/30W	24-BT00124	\$6.99
7388	Philips	6V 20W	Reichert Xcel 200	24-BT00986	\$16.99
64251	Osram Sylvania	6V 20W	Zeiss SL-20	24-BT00862	\$27.99
64260	Osram Sylvania	12V 30W	Haag-Streit 1080, Marco IV, G-11, GIV, GXX, Kowa SL-7 Nikon FS-2, FS-3, NS1, CS-2, Zeiss 30SLM	24-BT000864	\$20.99
4034020700	OptiSource	6V 20W	Topcon SL-2D, SL-1E, SL-2E, SL-4E, SL-7E, SL-3F Main, TRC-45AN, TRC-NW2	24-BT02762	\$79.99
1468X	OptiSource	6V 4.5A	AO/Reichert Main 11666, Campbell 11575, 11580	24-BT04094	\$16.99
3050F	OptiSource	6V 4.5A	Topcon SL-3D, SL-5D, SL-3E, SL-6E, Marco IIB, III, IV	24-BT02757	\$27.99
53Z	OptiSource	6V 25W	Zeiss 100/16, 125/16	24-BT02767	\$32.99

### Lensometers

MFPN	Manufacturer	Volts / Watts / Amps	Application	Code	Price
25S11FRE17110	OptiSource	110V 25W	Marco 101 Main Illuminator	24-BT02754	\$3.99
25S115C120V	GE	120V 25W	Woodlyn, B&L Vertometer 70	24-BT0002927	\$4.99
41310	Wiko	6V 15W	Topcon Main Bulb 75907	24-BT17201	\$10.99
4232010550	Topcon	6V 18W	Topcon Main Bulb LM-P5, LM-P6	24-BT16203	\$28.99
10S11N130V	OptiSource	120V 10W	AO/Reichert Old Style 11210, 11360,12604, 12610, 602, 603, 603A, 603B, Intermediate, Screw Base Clear	24-BT03986	\$1.99
15S11102120V	GE	120V 15W	Nikon 74900, LM-3, LM-4, OL-5	24-BT02808	\$2.99
15S11102CF115	Osram Sylvania	110V 15W	Topcon Main Bulb LM-2B, LM-3B, LM-3BC, LM-5, LM-5E,	24-BT0055465	\$1.99

### Keratometers and Ophthalmometers

MFPN	Manufacturer	Volts / Watts / Amps	Application	Code	Price
3006	OptiSource	120V 15W	Marco Main K-1, K-11	24-BT02756	\$2.99
41314	Wiko	6V 2.4W	Topcon Main OM-3, OM-4	24-BT17203	\$8.99
1468X	GE	6V 4.5A	AO/Reichert CLC	24-BT0001094	\$24.99
15S11102CF115	Osram Sylvania	110V 15W	Topcon OM-2	24-BT02844	\$3.99
15S1114120V	W.A. Equivalent	120V 15W	B&L 71-21-35, 71-26-61 AO/Reichert 12990, Burton 2040, Canon RK3, Woodlyn 55070	24-BT02748	\$1.99

### Ophthalmoscope, Indirect

MFPN	Manufacturer	Volts / Watts / Amps	Application	Code	Price
787	GE	6V 10W	Neitz Halogen 10-H, L-41, Halogen 10-H, Halogen L-41 Topcon Halogen 19001, Halogen 19010, ID-5	24-BR01014	\$11.99
1460	GE	6.5V 2.75A	AO/Reichert Indirect	24-BR0002747	\$11.99
3300	W.A. Equivalent	2.5V	Welch Allyn Equivalent G2624	24-BT03860	\$21.99
3800	Welch Allyn	2.5V	Welch Allyn Panoptic	24-BT00324	\$54.99



### Ophthalmoscope, Indirect (continued from previous page)

MFPN	Manufacturer	Volts / Watts / Amps	Application	Code	Price
3900	W.A. Equivalent	2.5V	Welch Allyn Equivalent	24-BT03863	\$19.99
X0488068	Heine	6V 10W	Propper Ind 199189	24-BT02505	\$89.99

### Ophthalmoscope, Direct

MFPN	Manufacturer	Volts / Watts / Amps	Application	Code	Price
3000	Welch Allyn	3.5V .720A	Welch Allyn Original / 11600, 11605, 11610, 11710	24-BT00342	\$36.99
3000	W.A. Equivalent	3.5V .720A	Welch Allyn Equivalent / 11600, 11605, 11610, 11710	24-BT01069	\$23.99
4900	Welch Allyn	3.5V .720A	Welch Allyn Original / 11620, 11630, 11720, 11730, 11735E	24-BT00354	\$47.99
4900	W.A. Equivalent	3.5V .720A	Welch Allyn Equivalent 11620, 11630, 11720, 11730, 11735E	24-BT01074	\$16.99
1011P5055	OptiSource	3.5V	Keeler (Per 2 Pack)	24-BT03945	\$155.99
1012P5006	OptiSource	6V 18W	Keeler Indirect	24-BT03947	\$129.99
1012P5110	OptiSource	6V 10W	Keeler All Pupil, Vantage, (Per 2 Pack)	24-BT02744	\$179.99
X0188042	Heine	2.5V	Heine	24-BT02474	\$46.99

### Perimeter

MFPN	Manufacturer	Volts / Watts / Amps	Application	Code	Price
940750	OptiSource	6V 4.5A	Marco 2007, Haag-Streit Main Bulb 940-750, Goldman Main Bulb	24-BT04976	\$29.99
6V33WSC	OptiSource	6V 33W	Topcon Main Bulb SBP-2020	24-BT04816	\$23.99

### Radiuscopes

MFPN	Manufacturer	Volts / Watts / Amps	Application	Code	Price
1493	GE	6.5V 2.75A	AO/Reichert 11231	24-BT02807	\$8.99

### Retinoscopes

MFPN	Manufacturer	Volts / Watts / Amps	Application	Code	Price
3000	W.A. Equivalent	2.5V	Welch Allyn Equivalent 18000	24-BT01069	\$23.99
3000	Welch Allyn	2.5V	Welch Allyn 18000	24-BT00342	\$35.99
X0288048	Heine	3.5V	Heine	24-BT02495	\$44.96
X0288089	Heine	3.5V	Heine	24-BT02508	\$47.99
X0288090	Heine	3.5V	Heine	24-BT02503	\$38.99

### Tonometers

MFPN	Manufacturer	Volts / Watts / Amps	Application	Code	Price
328	W.A. Equivalent	6V 1.2W	AO/Reichert Non-Contact Tonometer (10 pcs)	24-BT02758	\$9.99

### Transilluminators

MFPN	Manufacturer	Volts / Watts / Amps	Application	Code	Price
994	Carley	3.5V .720A	Welch Allyn Equivalent Transilluminator 27000, 27050, 26500, 41100, 43300	24-BT01073	\$15.99
3100	Welch Allyn	3.5V .720A	Welch Allyn Transilluminator 27000, 27050, 26500, 41100, 43300	24-BT00343	\$30.99

### Microscopes

MFPN	Manufacturer	Volts / Watts / Amps	Application	Code	Price
64260	Osram Sylvania	12V 30W	Various	24-BT00864	\$20.99
64250HLX	Osram Sylvania	6V 20W	Various	24-BT00861	\$41.99
64634HLX	Osram Sylvania	15V 150W	Various: Marco/Topcon/Zeiss	24-BT00931	\$11.99
EPN	GE	12V 35W	Various	24-BT01488	\$43.99

### Batteries

MFPN	Manufacturer	Volts / Watts / Amps	Application	Code	Price
72200	Welch Allyn	3.5V	Welch Allyn Nicad Rechargeable for Handle	24-BT02926	\$53.99
72200	W.A. Equivalent	3.5V	Welch Allyn Equivalent Nicad Rechargeable for Handle	24-BT39692	\$41.99
72000	Welch Allyn	2.5V	Welch Allyn Nicad Rechargeable for Otoscope Handle	24-BT16999	\$53.99
72000	W.A. Equivalent	2.5V	Welch Allyn Equivalent Nicad Rechargeable for Otoscope Handle	24-BT39691	\$41.99
72300	Welch Allyn	3.5V	Welch Allyn Nicad Rechargeable for Convertible Handle	24-BT17002	\$53.99
72300	W.A. Equivalent	3.5V	Welch Allyn Equivalent Nicad Rechargeable for Convertible Handle	24-BT39693	\$41.99
72600	Welch Allyn	2.5V	Welch Allyn Nicad Rechargeable for Power Handle	24-BT17004	\$84.99
72600	W.A. Equivalent	2.5V	Welch Allyn Equivalent Nicad Rechargeable for Power Handle	24-BT04846	\$26.99
360HOP	TD	3.5V	Equivalent Battery for Optec No. 360 Retinoscope	24-BT360HOP	\$43.99
224	TD	5.0V	Equivalent Battery for Marco/Mentor 22-4515 B.A.T.	24-BT0011625	\$78.99
191	TD	3.5V	Equivalent Battery for Keeler Battery # 1919P5020 Vista 20 Handle	24-BT0005258	\$50.99



# ACCESSORIES

Passion for Fashion

You complete your first pair sale, lens upgrades, and second pair sale; now, what other products do you offer patients? Explore our diverse selection of accessories to enhance, protect, and complement your patient's new eyewear investment, all designed with a **Passion for Fashion** to keep them looking their best. OptiSource's newly expanded accessories include patented custom and semi-custom clip-on sunglasses, creative cases, temple decorations, and fashionable eyewear retainers. Additional accessory items include novelty and ECP-only reading glasses, eyewear holders, goggles, and low-vision products.





OptiPets are the creative, collectible, and fun-to-use eyeglass holder. Each hand-painted piece has a cradle designed to hold folded frame temples.

Originally introduced to spice up storefronts and frame counters, OptiPets have quickly become an incredibly popular accessory item that sells itself. OptiPets have become the go-to gift item for the hardest to shop for men, women, and children.

- Perfect for nightstands, desks, kitchen counters, and end tables
- Patients will always know exactly where their glasses are

## Display

18-FG-KND \$19.99

## Animal Collections

Our animal collections are a staple item for children's frame displays, pediatric dispensaries, and collectors of all things animals.



### Animals

- 6 piece set

18-FG-AN \$47.99



### Domestic Animals

- 6 piece set

18-E15018 \$35.99



### Puppies

- 12 piece set

18-B11034 \$47.99



### Kittens

- 12 piece set

18-F57778GRP \$47.99





## Jungle Animals

• 12 piece set

18-E15013

\$71.99



## Dinosaurs

• 6 piece set

18-E15513

\$35.99

## Breed Specific Collection

\$14.99  
each

These United Kingdom born original designs are heavy-weight, hand-painted, and have a high-shine glazed finish. These adorable versions of popular breeds are the crown jewel of the OptiPets range. They uniquely dress up any décor and are a must-have for your pet loving patients.



German Shepherd	18-E15511
Chihuahua	18-E15555
Beagle	18-E15559
Black Poodle	18-E15558
Westie	18-E15512
Dachshund	18-E15556

German Shepherd, Chihuahua, Beagle, Black Poodle, Westie, Dachshund



Red Setter, St. Bernard, Shih-Tzu, Dalmatian, Pug

Red Setter	18-E15800
St. Bernard	18-E15562
Shih-Tzu	18-E15485
Dalmatian	18-E15563
Pug	18-E15560



\$14.99  
each



Pekingese	18-E40006
Labrador	18-E15561
Rottweiler	18-E40011
Basset Hound	18-E40000
CKC Spaniel	18-E40001

Pekingese, Labrador, Rottweiler, Basset Hound, CKC Spaniel



White Poodle	18-E42024
Springer Spaniel	18-E42022
English Bulldog	18-E42027

White Poodle, Springer Spaniel, English Bulldog



Black Labrador	18-E42025
Chocolate Labrador	18-E42021
Boxer	18-E42023
Yorkie	18-E42026

Black Labrador, Chocolate Labrador, Boxer, Yorkie

Breed Specific Collection

\$14.99  
each



Comet, Siamese, Nuky



Tigger, Jess, Sheba

Comet Cat	18-E42030
Siamese Cat	18-E42028
Nuky Cat	18-E42029
Tigger Cat	18-E40007
Jess Cat	18-E40005
Sheba Cat	18-E40010
Meerkat	18-E15557

Meerkat





## Fish and Frogs

The six-piece Art Fish collection features intricate hand paint work that contrasts frame colors. Our Frogs have won the hearts of ECPs and patients around the world. And of course, who could forget the beloved Ugly Fish? These bug-eyed creations are a conversation piece and hold frames with their temples open.



### Ugly Fish

- 3 piece set

18-E15700

\$29.99



### Art Fish

- 6 piece set

18-FG-FS

\$53.99

### Frogs

- 6 piece set

18-A10600

\$53.99





## Specialty Noses

Our handmade Glass Noses are understated classic designs. The translucent palette adds a splash of color to otherwise plain store displays. Tupton Noses are the only collection to feature real ceramics. The hand-sculpted raised designs, original floral patterns, and glazed finish provide a rich look and feel.



### Glass Noses

- 6 piece set

18-GLASS \$89.99



### Tupton Noses

- 6 piece set

18-TUPTON \$64.99





## Artful Noses

Our artful nose collections offer a design for every taste. We are proud to offer the largest collection of eyewear holders and continuously add to the range. Our hand-painted designs range from elegant florals to bling-studded lip-noses.



### Picasso Lip Noses

• 12 piece set

18-FG-PLN

\$65.99



### Abstract Noses

• 12 piece set

18-FG-AB

\$65.99



## Butterfly Noses

• 6 piece set

18-FG-BBN \$53.99



## Chrome Noses

• 2 piece set

18-FG-CHM2 \$15.99

## Sea Coral Noses

• 6 piece set

18-FG-SC \$47.99



## Bling Noses

• 6 piece set

18-FG-BLN \$53.99



# Sport Noses

Looking for an imaginative way to display your new sports frame line? How about the perfect gift for the family athlete, Mother's Day, Father's Day, or stocking stuffer? Our sport noses are a top-selling part of the OptiNoses line thanks to their original creative design and character.

**\$7.99**  
each



Baseball	18-FG-B
Basketball	18-FG-BB
Football	18-FG-FB
Male Golf	18-FG-G
Female Golf Blue	18-FG-GBLUE
Female Golf Pink	18-FG-GPINK
Ice Hockey	18-FG-H
Soccer	18-FG-SB
Tennis	18-FG-T



## Stem Noses

• 3 piece set

18-E15400      \$39.99

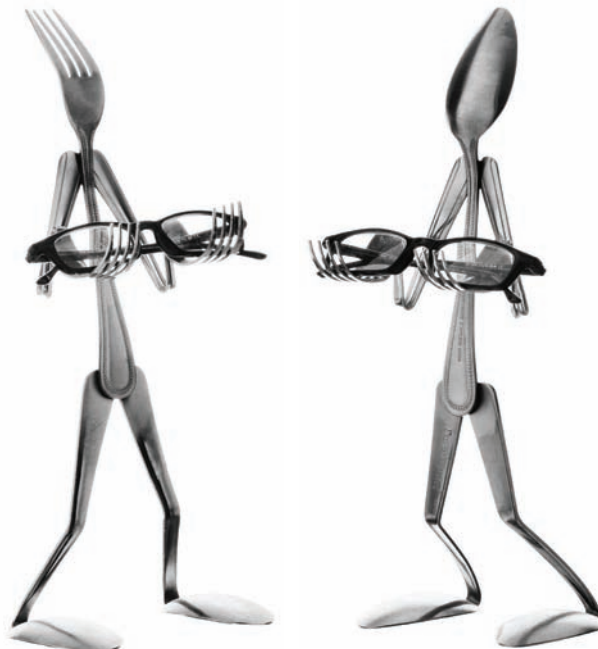

## Fork n' Spoon

• 2 piece set

18-FORKSPOON      \$29.99

# Reading Glasses Collections



Don't miss out on another sale! Our diverse line of readers offers a style and price point for every consumer, without competing with your frame board.

Whether you're currently selling readers or have decided to join the 25 million dollar reader market, we have you covered.

# Kodak Lens Folding Reading Glasses

\$12.50 each



Telescoping Temples Fold These Glasses to the Size of a Zippo® Lighter

The design technology allows the glasses to easily fold into the size of a Zippo® lighter and fit inside a stylish, durable **Kodak** Lens branded hard case. These compact folding reading glasses bear the name and lens technology of one of the world's most trusted consumer brands.

- Patented telescoping temples
- Resilient spring hinges
- Comfortable built-in nose pads
- Micro-size **Kodak** Lens branded case



## Frame Colors

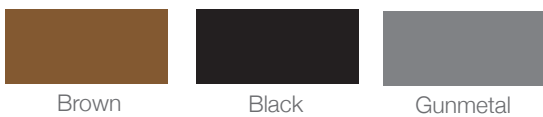

Readers not included

Display holds 24 readers

26-10000 \$47.99

### How to Order

1. Build item number beginning with 26-
2. Add color code
3. Add power code

Color Codes  
Brown: 10, Black: 11, Gunmetal: 12

Power Codes  
150, 200, 250, 300

### Sample Product Code

Note: All product codes start with 26-

26- 11 150

Item # Color Code Power



## ACCESSORIES

### Light Specs

#### Patented LED Reading Glasses



Liberty Black

AS SEEN ON TV reading glasses now conveniently available to your patients. We offer the full line of colors and styles for both men and women. Light Specs are great in low light situations such as restaurants and reading in bed. They also make great task lighting for hobbyists, auto repair, and much, much more.



Berry



Purple



Black



Red

Liberty Black	+1.50	53-1010433-150
	+2.00	53-1010433-200
	+2.50	53-1010433-250
Liberty Tortoise	+1.50	53-1010434-150
	+2.00	53-1010434-200
	+2.50	53-1010434-250
Lyle Black	+1.50	53-1011525-150
	+2.00	53-1011525-200
	+2.50	53-1011525-250
Lady Liberty Black	+1.50	53-1011526-150
	+2.00	53-1011526-200
	+2.50	53-1011526-250
Lady Liberty Purple	+1.50	53-1011529-150
	+2.00	53-1011529-200
	+2.50	53-1011529-250
Lyle Tortoise	+1.50	53-1011530-150
	+2.00	53-1011530-200
	+2.50	53-1011530-250
Lady Liberty Red	+1.50	53-1011552-150
	+2.00	53-1011552-200
	+2.50	53-1011552-250

\$14.99  
each

\$17.99  
each

### Display

9 pc. Wire Display Rack  
53-P3047-70291 \$9.99

### Pod Readers

\$9.99  
each

#### The All-In-One Reader with Built-In Case

The amazing Pod Readers' swivel temples create a stylish design that also doubles as a protective case.



Sky Blue (1)

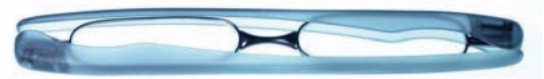

Mocha Brown (2)



Cool Gray (3)



Plum Purple (4)



Soft Red (5)



Sunrise Yellow (6)

#### How to Order

1. Build item number beginning with 13-
2. Add color code. See above.
3. Add power code.

Power Codes  
100, 150, 200, 250, 300

#### Sample Product Code

Note: All product codes start with 13-

13-	1	150
Item #	Color Code	Power Code

### Display

Includes 30 assorted readers  
13-1000 \$229.99





# Blade Readers

\$14.99 each



Patented Pocket Blade Readers feature swivel temples that create a durable case. Small and lightweight, the Pocket Blade is the ideal reader for people on the go.

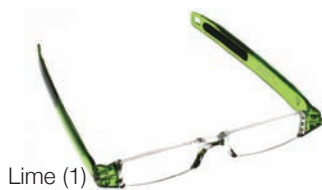

Lime (1)



Plum (2)



Black (3)



Ice (4)



Red (5)



Blue (6)

## How to Order

1. Build item number beginning with 99-276-
2. Add color code. See above.
3. Add power code.

Power Codes  
100, 150, 200, 250, 300

## Sample Product Code

Note: All product codes start with 99- 276-

99-276- 1 150

Item #      Color Code      Power Code

## Display

Trendy display highlights the key features of the Pocket Blade and holds 8 pieces.

99-276-1000

\$36.99



\$5.99 each



The Latest Trend in Novelty Readers

Cleverly designed readers with memory-plastic temples that gently and securely hang around the neck when not in use.

- Three fashionable styles to choose from
- Unique temple design ensures that you are never without your readers
- Available powers: 1.00, 1.25, 1.50, 1.75, 2.00, 2.50, 3.00



Style shown is Ultra in blue

Oval (style #1)



Black (color #1)



Brown/Orange (color #2)



Red (color #3)



Blue (color #4)

Rectangle (style #2)



Black (color #1)



Blue (color #2)



Brown (color #3)

Ultra (style #3)



Black (color #1)



Blue (color #2)



Brown (color #3)

How to Order

1. Build item number beginning with 20-242-
2. Add style code from above.
3. Add color code from above.
4. Add power code.

Power Codes  
100, 125, 150, 175, 200, 250, 300

Sample Product Code

Note: All product codes start with 20-242-

20-242-	1	1	150
Item #	Style Code	Color Code	Power Code



Empty Display

20-242-999 \$49.99

## Preferred Collection

Preferred readers offer high style without the high price. These mid-level readers offer better-than-drugstore style at comparable prices, and include a matching soft case. With the assistance of an optical professional to find the best power, style, and fit, your customers will never shop elsewhere for readers.

**\$7.99**  
each

### How to Order

1. Build item number beginning with 96-
2. Add two-digit style code
3. Add two-digit color code
4. Add power code: 150, 200, or 250

### Sample Product Code

Note: All product codes start with 96-

96-1101150

Item #	Style Code	Color Code	Power
96-	11	01	150

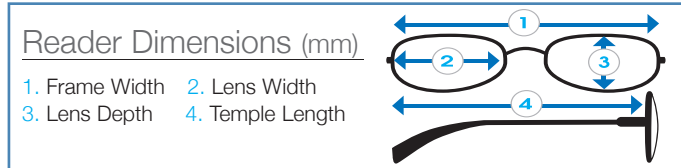

## Illusion

Style code: 01

Frame Width	135
Lens Width	52
Lens Depth	25
Temple Length	136



Color code: 19



Color code: 89



Color code: 66

## Fantasia

Style code: 02

Frame Width	137
Lens Width	52.6
Lens Depth	31.8
Temple Length	142



Color code: 14



Color code: 45



Color code: 87



Preferred Collection

\$7.99  
each

Daydream

Style code: 03

Frame Width 136  
Lens Width 49.7  
Lens Depth 24  
Temple Length 139



Color code: 55



Color code: 11

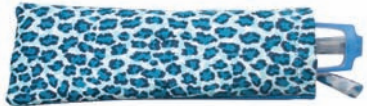

Color code: 66



Visionaire

Style code: 04

Frame Width 140  
Lens Width 50  
Lens Depth 35  
Temple Length 147



Color code: 54



Color code: 89



Color code: 87



\$7.99  
each

Preferred Collection

Kurios

Style code: 05

Frame Width 138  
Lens Width 50.5  
Lens Depth 34  
Temple Length 147



Color code: 87



Color code: 73



Color code: 89



Persian

Style code: 06

Frame Width 138  
Lens Width 49  
Lens Depth 26  
Temple Length 145



Color code: 13



Color code: 63



Color code: 43



Preferred Collection

\$7.99  
each

Intrigue

Style code: 07

Frame Width 128  
Lens Width 49.5  
Lens Depth 28  
Temple Length 142



Color code: 74



Color code: 71



Color code: 81



Ezy

Style code: 08

Frame Width 137  
Lens Width 52.5  
Lens Depth 34.5  
Temple Length 141



Color code: 55



Color code: 87



Color code: 11





\$7.99  
each

Preferred Collection

Virtuoso

Style code: 09

Frame Width 135  
Lens Width 45  
Lens Depth 37  
Temple Length 145



Color code: 74



Color code: 11



Color code: 23

London

Style code: 10

Frame Width 140  
Lens Width 54.5  
Lens Depth 27  
Temple Length 141



Color code: 81



Color code: 83



Color code: 89

Preferred Collection

\$7.99  
each

Nikito

Style code: 11

Frame Width 134  
Lens Width 47  
Lens Depth 38.6  
Temple Length 141



Color code: 17



Color code: 53



Color code: 78



Carter

Style code: 12

Frame Width 135  
Lens Width 51  
Lens Depth 37  
Temple Length 141



Color code: 87



Color code: 57



Color code: 89



\$7.99  
each

Preferred Collection

Concerto

Style code: 13

Frame Width 130  
Lens Width 49  
Lens Depth 27.6  
Temple Length 134



Color code: 88



Color code: 55



Color code: 11



All Concerto readers come with a clear plastic case

Glamour

Style code: 14

Frame Width 134  
Lens Width 52  
Lens Depth 27  
Temple Length 137



Color code: 83



Color code: 11



Color code: 85



CHEMISTRY

MACHINERY

EDGING

SURFACING

TOOLS

FRAME PARTS

EXAM SUPPLIES

ACCESSORIES

LENS CLEANERS



Preferred Collection

\$7.99  
each



All readers on pages 148 and 149  
come with a black stitched black soft case

Crusade

Style code: 15

Frame Width 135  
Lens Width 51  
Lens Depth 37  
Temple Length 141



Color code: 88



Color code: 11

Botero

Style code: 16

Frame Width 133  
Lens Width 54  
Lens Depth 28.5  
Temple Length 145



Color code: 88



Color code: 77

Zara

Style code: 17

Frame Width 124  
Lens Width 51  
Lens Depth 26.4  
Temple Length 135



Color code: 89



Color code: 19

\$7.99  
each

Preferred Collection

Carnegie

Style code: 18

Frame Width 136  
Lens Width 52  
Lens Depth 29  
Temple Length 141



Color code: 89



Color code: 77

Daly

Style code: 19

Frame Width 136  
Lens Width 52  
Lens Depth 30  
Temple Length 135



Color code: 88



Color code: 77

Alejandro

Style code: 20

Frame Width 135  
Lens Width 50  
Lens Depth 27  
Temple Length 132



Color code: 88



Color code: 77

## Elite Collection

\$19.99  
each

Elite readers are our highest quality reading glasses. These ophthalmic quality frames include both timeless designs and today's best-selling styles, and are made with premium materials: acetate, titanium, and natural wood. Each piece is hand-made to the highest standards and includes a premium case.

### How to Order

1. Build item number beginning with 96-
2. Add two-digit style code
3. Add two-digit color code
4. Add power code: 150, 200, or 250

### Sample Product Code

Note: All product codes start with 96-

96-1101150

Item #	Style Code	Color Code	Power
96	11	01	150

## Chic (acetate)

Style code: 21

Frame Width	139
Lens Width	54
Lens Depth	28
Temple Length	140



Color code: 86



Color code: 66

## Monaco (acetate)

Style code: 22

Frame Width	136
Lens Width	53
Lens Depth	31
Temple Length	145



Color code: 51



Color code: 65

## Falkao (acetate)

Style code: 23

Frame Width	138
Lens Width	53
Lens Depth	33
Temple Length	140



Color code: 55



Color code: 87





All readers on pages 150 and 151 come with a stylish black hard case with magnetic cover

### Jackie J. (acetate)

Style code: 24

Frame Width	136
Lens Width	53
Lens Depth	37
Temple Length	145



Color code: 64



Color code: 63

### Alva E. (titanium)

Style code: 25

Frame Width	129
Lens Width	52
Lens Depth	29.8
Temple Length	140



Color code: 88



Color code: 77

### Soho (acetate/wood)

Style code: 26

Frame Width	140
Lens Width	54
Lens Depth	39
Temple Length	140



Color code: 77



Color code: 87

## Ultimate Collection

\$19.99  
each

The frames in this section are constructed of Ultimate™, a breakthrough material that is ultra-feather-light, ultra-flexible, and virtually indestructible.

### Miss

Frame Width	140
Lens Width	53
Lens Depth	30
Temple Length	140

Style code: 33



Color code: 55



Color code: 81



Color code: 66

### Max

Frame Width	137
Lens Width	52
Lens Depth	34
Temple Length	140

Style code: 34



Color code: 88



Color code: 89



Color code: 77

### Min

Frame Width	134.5
Lens Width	52
Lens Depth	29
Temple Length	140

Style code: 35



Color code: 88



Color code: 55



Color code: 77

# Basic Collection

**\$4.99**  
each

Basic Readers are for the value-conscious consumer. These single piece injection molded frames offer simple styling at a value price and include a basic case.

### How to Order

1. Build item number beginning with 96-
2. Add two-digit style code
3. Add two-digit color code
4. Add power code: 150, 200, or 250

### Sample Product Code

Note: All product codes start with 96-

**96-1101150**

Item #	Style Code	Color Code	Power
96-	11	01	150

## Cheers

Style code: 27

Frame Width 134  
Lens Width 45.5  
Lens Depth 18  
Temple Length 134



Color code: 88



Color code: 63

## Cassandra

Style code: 28

Frame Width 136  
Lens Width 50  
Lens Depth 23.7  
Temple Length 150



Color code: 64



Color code: 76

## Tavio

Style code: 29

Frame Width 134  
Lens Width 46.5  
Lens Depth 23  
Temple Length 142



Color code: 88



Color code: 73

Basic Collection

\$4.99  
each

Charlotte

Style code: 30

Frame Width 134.5  
Lens Width 50  
Lens Depth 27  
Temple Length 140



Color code: 19



Color code: 98

Charlotte and Tokyo readers come with a clear tube hard case

Tokyo

Style code: 31

Frame Width 129  
Lens Width 52  
Lens Depth 29.8  
Temple Length 140



Color code: 88



Color code: 55



Mozil

Style code: 32

Frame Width 120  
Lens Width 45  
Lens Depth 23  
Temple Length 138



Color code: 88



Color code: 64





# Chemistrie

## Patented Micro-Magnetic Clip-On

Chemistrie is the best fitting, lightest weight custom clip-on available. It boasts an ingenious embedded magnetic system and wafer-thin polarized lenses. Chemistrie produces an amazing custom fit for any style or shape frame.



- Point of sale display includes 4 free clips, a \$260 value
- 100% custom-made at our lab for precision fit
- Call for assistance 1-800-OptiSource (678-4768)
- See our video at: [www.1-800-optisource.com/accessories.aspx](http://www.1-800-optisource.com/accessories.aspx)

Point of Sale Display	88-CHEMDISPLAY	\$250.00
Solid Sunlens	88-CHEMSOLID	\$65.00
Mirrored Sunlens	88-CHEMMIRROR	\$70.00
Gradient Sunlens	88-CHEMGRADIENT	\$70.00
Reader Lens	88-CHEMREADER	\$75.00
3D Lens	88-CHEM3D	\$67.50
Crystals Glued To Sunlens	88-CHEMCRYSTALGLUE	\$5.00
Magnetic Crystals	88-CHEMCRYSTALMAG	\$5.00
Retrofit Charge	88-CHEMRETROFIT	\$10.00
Lens Prism \$10/Diopter	88-CHEMPRISM	\$10.00



### Sunlens Shades Colors



### Sunlens Mirror Colors

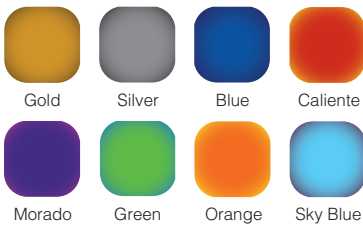

### Sunlens Gradient Colors



### Bridges

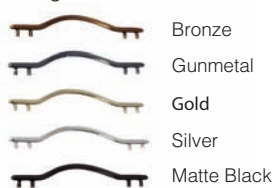

### Magnets

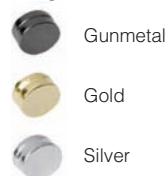

### Swarovski Jewel Colors

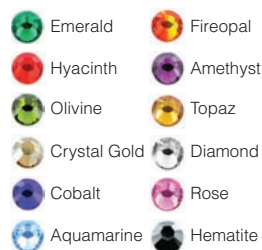

Parts and accessories only available with clip-on order.



# Kodak Lens Clip-On Sunglasses

**\$19.99**  
per clip

Free Case with Every Clip



## Introducing Kodak Lens Clip-On Sunglasses

These are the only clip-ons whose quality, features, and benefits can bear the name of one of the world's most trusted consumer brands.

The **Kodak** Lens clip-on sunglasses are made of .7mm Tri Acetate Cellulose (TAC) lenses.

### Frameless Design Technology

- Rimless style provides a barely-there look and feel
- Ever-Crimp™ hooks use no screws or rivets
- Adjustable nose bridge and hooks provide a near-custom fit



Complete fitting kit includes 43 clip-ons in three boxes



POP display



### How to Order

1. Build item number beginning with 49-  
(See fitting guide pages for both shape code and shape size availability.)
2. Add shape number.
3. Add shape size.
4. Add lens color code.  
Gray (color code 1)  
Brown (color code 2)

### Sample Product Code

Note: All product codes start with 49-

49-	10	52	1
	Shape	Size(mm)	Color

POP Display	49-2991-1	\$39.99
43 Piece Fitting Kit	49-3000	\$515.59
Empty Fitting Box	49-2000	\$29.99



Kodak trademark and trade dress are used under license from Kodak by OptiSource.

# Kodak Lens Clip-Ons Actual Size Fitting Guide

Place frames over the best-fitting colored shape



**DRX** Shape 10

52mm  
54mm  
56mm

**EXX** Shape 11

55mm  
57mm

**Modified Oval** Shape 12

50mm  
52mm

**MDX** Shape 13

52mm  
54mm

**Modified Rectangle** Shape 14

48mm  
50mm  
52mm  
54mm

**Oval** Shape 15

46mm  
48mm  
50mm  
52mm



## Kodak Lens Clip-Ons Actual Size Fitting Guide

Place frames over the best-fitting colored shape

**Rectangle**  
Shape 16

48mm  
50mm  
52mm  
54mm  
56mm

**Slim Rectangle**  
Shape 17

50mm  
52mm  
54mm  
56mm

**SLX**  
Shape 18

52mm  
54mm

**Square**  
Shape 19

52mm  
54mm  
56mm

**Tru-Rectangle**  
Shape 20

48mm  
50mm  
52mm  
54mm  
56mm  
58mm

**Lo-Rectangle**  
Shape 21

46mm  
48mm  
50mm  
52mm  
54mm  
56mm





## D-Clips® Clip-Ons













**\$6.99**  
per clip

Free Case  
with Every Clip

Premium Quality All-Metal  
Patented Alloy Construction

The D-Clips line features the DDO Flip-Clip, a patented, virtually unbreakable clip mechanism. The clip mechanism has a proprietary coating to protect ophthalmic lenses and prevent shifting and scratching lenses.

- Convenient one hand application to Rx frames
- Designed to ensure that the polarized horizontal axis is never compromised
- Polarized shatter proof lenses

 Deep Rectangle Size: 54 x 31 Shape C1	 Narrow Rectangle Size: 52 x 31 Shape C2	 Tru Rectangle Size: 53 x 29 Shape TRUX
 Small Aviator Size: 54 x 48 Shape H1	 Large Aviator Size: 60 x 51 Shape H2	 Lo Rectangle Size: 56 x 31 Shape XLO
 Small Oval Size: 50 x 37 Shape V1	 Oval Size: 54 x 38 Shape V2	 Rectangle Size: 58 x 47 Shape 5
 Small Rectangle Size: 47 x 33 Shape X1	 Medium Rectangle Size: 52 x 35 Shape X2	 Large Rectangle Size: 62 x 39 Shape X3

### How to Order

1. Build item number beginning with 67-FLIP  
(See fitting guide pages for both shape code and shape size availability.)
2. Add shape number from above.
3. Add lens color code.  
Gray (color code GR)  
Brown (color code BR)

### Sample Product Code

Note: All product codes start with **67-FLIP**

67-FLIP	C1	GR
	Shape	Color

### Clip Colors:

Black Clip / Gray Lens  
or Bronze Clip / Brown Lens

### Lens Colors:

Gray or Brown Polarized



## Shade Control® Clip-Ons

**\$20.99**  
per clip

Free Case with Every Clip

Premium Quality Stainless Steel Frames  
with Patented Concealed Spring Top-Bar

Shade control polarized clip-ons will fit 96% of optical frames. The concealed spring keeps the clip at a perfect horizontal axis. The upscale fitting kit is ideal for presentation, fitting, and selling.

- Patented concealed spring
- Adjustable hooks
- Functional rimlocks



### How to Order

1. Build item number beginning with 67-  
(See fitting guide pages for both shape code and shape size availability.)
2. Add shape code from the following pages.
3. Add frame size.
3. Add frame color code.  
Black: BL     Bronze: BR  
Gold: GO     Gunmetal: GU
4. Add lens color code.  
Gray: 1     Brown: 2

### Sample Product Code

Note: All product codes start with 67-

67-	XLO	54	BL	1
	Shape	Size	Frame Color	Lens Color

### 28 Piece Starter Kit

67-28STARTERKIT     \$399.99

US Patent # 6,234,628  
EU Patent 1116984

# Shade Control® Clip-Ons Actual Size Fitting Guide

Place frames over the best-fitting colored shape

**Tru-Rectangle**  
Shape code TRUX

Not available in gold frame

- 48mm
- 50mm
- 52mm
- 54mm
- 56mm

**Lo-Oval**  
Shape code OLO

- 42mm
- 44mm
- 46mm
- 48mm
- 50mm

**Lo-Rectangle**  
Shape code XLO

- 44mm
- 46mm
- 48mm
- 50mm
- 52mm
- 54mm
- 56mm

**MDX**  
Shape code MDX

Not available in gold frame

- 52mm
- 54mm

**Modified Rectangle**  
Shape code MODX

- 46mm
- 48mm
- 50mm
- 52mm
- 54mm

**Almond**  
Shape code ALM

- 48mm
- 50mm
- 52mm

**Rectangle**  
Shape code X

- 48mm
- 50mm
- 52mm
- 54mm
- 56mm

**Mod-Oval**  
Shape code MODO

Not available in gold frame

- 50mm
- 52mm

# Shade Control® Clip-Ons Actual Size Fitting Guide

**\$20.99**  
per clip

**Deep Rectangle**  
Shape code DRX

Not available in gold frame

52mm  
54mm  
56mm

**EXX**  
Shape code EXX

Not available in gold frame

56mm  
58mm

**Slim Rectangle**  
Shape code Slim

Not available in gold frame

48mm  
50mm  
52mm  
54mm  
56mm

**Oval**  
Shape code O

42mm  
44mm  
46mm  
48mm  
50mm  
52mm

**Square**  
Shape code S

Not available in black frame

52mm  
54mm  
56mm  
58mm

**SLX**  
Shape code SLX

Not available in gold frame

52mm  
54mm

**Round**  
Shape code R

46mm  
48mm  
50mm

**Cat Eye**  
Shape code C

48mm  
50mm  
52mm



## Custom Imprinting for Eyeglass Cases

OptiSource offers you the opportunity to add your brand identity and/or company statement to any of our cases. Include your logo, phone number, address(es), and website for customers to easily contact you.

Our in-house art department can assist you with production.

Cases – 300 pieces minimum for custom imprinting.  
Add \$.15 for printing

### Pad Printing



### Hot Foil Stamping



### Embossing



## Clamshell Cases

100 per case



### Mini-Checkerboard

Large  
\$1.19

Black 56-C113-BK  
Assorted 56-C113-AST



### Leatherette

Medium  
\$1.09

Black 56-C103-BK  
Assorted 56-C103-AST



### Leatherette

Medium  
\$1.09

Black 56-C106-BK  
Assorted 56-C106-AST

# Clamshell Cases

100 per case

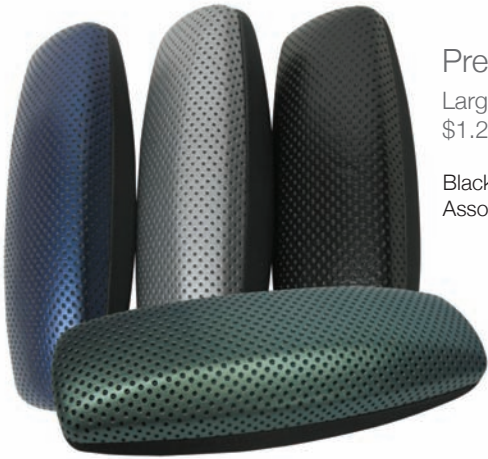

Premium Dotted

Large  
\$1.29

Black 56-C108-BK  
Assorted 56-C108-AST



Glossy Two-Toned

Medium  
\$1.19

Blue 56-C145-A-BL  
Pink 56-C145-A-PK  
White 56-C145-B-WT  
Red 56-C145-B-RD  
Assorted 56-C145-AST



Matte

Medium  
\$1.09

Black 56-C109-BK  
Brown 56-C109-BN  
Maroon 56-C109-MN  
Navy 56-C109-NV  
Silver 56-C109-SL  
Assorted 56-C109-AST



Tribal Floral

Medium  
\$1.44

Assorted 56-C190-AST



Plush Metallic

Large  
\$1.29

Assorted 56-C158-AST



Rich Leatherette

Medium  
\$1.49

Assorted 56-C152-AST

# Clamshell Cases

100 per case



Glossy  
Extra-Large  
\$1.69

Black 56-C124-BK  
Red 56-C124-RD



Basic Clamshell  
Medium  
\$1.09

Black 56-C131-BK  
Assorted 56-C131-AST



Leatherette  
Medium  
\$1.09

Black 56-C135-BK  
Assorted 56-C135-AST



Rich Leatherette  
Large  
\$1.69

Black 56-C112-BK  
Assorted 56-C112-AST



Snake Skin  
Medium  
\$1.09

Assorted 56-C155-AST



Leatherette Sun Case  
Extra-Large  
\$1.89

Black 56-CS001-BK  
Assorted 56-CS001-AST



CHEMISTRY

MACHINERY

EDGING

SURFACING

TOOLS

FRAME PARTS

EXAM SUPPLIES

ACCESSORIES

LENS CLEANERS



# Clamshell Cases

100 per case



Brushed  
Large  
\$1.09  
Black 56-C132-BK  
Assorted 56-C132-AST



Diamond  
Medium  
\$1.19  
Black 56-C123-BK  
Assorted 56-C123-AST



Bright Plush  
Medium  
\$1.69  
Assorted 56-C129-AST



Rich Leatherette  
Large  
\$1.69  
Black 56-C147-BK  
Assorted 56-C147-AST



Premium Dotted  
Medium  
\$1.09  
Black 56-C150-BK  
Assorted 56-C150-AST



# Clamshell Cases

100 per case



**Diamond**  
 Medium  
 \$1.29  
 Black 56-C161-BK  
 Assorted 56-C161-AST



**Diamond**  
 Large  
 \$1.49  
 Black 56-C164-BK  
 Brown 56-C164-BN  
 Maroon 56-C164-MN  
 Assorted 56-C164-AST



**Diamond**  
 Small  
 \$1.19  
 Black 56-C160-BK  
 Maroon 56-C160-MN  
 Brown 56-C160-BN  
 Assorted 56-C160-AST



**Matte**  
 Small  
 \$1.09  
 Black 56-C159-BK  
 Maroon 56-C159-MN  
 Brown 56-C159-BN  
 Assorted 56-C159-AST



**Matte**  
 Large  
 \$1.29  
 Black 56-C163-BK  
 Brown 56-C163-BN  
 Maroon 56-C163-MN  
 Assorted 56-C163-AST



**Matte**  
 Medium  
 \$1.29  
 Black 56-C162-BK  
 Assorted 56-C162-AST

CHEMISTRY

MACHINERY

EDGING

SURFACING

TOOLS

FRAME PARTS

EXAM SUPPLIES

ACCESSORIES

LENS CLEANERS

# Semi-Hard Cases

100 per case

Leatherette

Small  
\$1.39



Black 56-SHS01-BK  
Assorted 56-SHS01-AST

Leatherette

Medium  
\$1.49



Black 56-SHM01-BK  
Assorted 56-SHM01-AST

Leatherette

Large  
\$1.69



Black 56-SHL01-BK  
Assorted 56-SHL01-AST



Croc  
Small  
\$1.39  
Assorted 56-SHS06-AST



Croc  
Medium  
\$1.49  
Assorted 56-SHM06-AST



Animal Print  
Small  
\$1.59  
Assorted 56-SHS09-AST



Animal Print  
Large  
\$1.69  
Assorted 56-SHL09-AST

# Semi-Hard Cases

100 per case

Abstract Camo

Small  
\$1.59



Assorted 56-SHS17-AST

Abstract Camo

Medium  
\$1.99



Assorted 56-SHM17-AST

Paisly Print

Small  
\$1.49



Assorted 56-SHS12-AST

Abstract Squares

Small  
\$1.69



Assorted 56-SHS18-AST

Abstract Squares

Medium  
\$1.99



Assorted 56-SHM18-AST



# Soft Slip-In Cases

200 per case

Abstract Squares

\$.99



Assorted 56-SIF13-AST

Satin Dots

\$.89



Assorted 56-SIF09-AST

Animal Print

Medium

\$.79

Assorted 56-SIL06-AST



Abstract Camo

\$.89



Assorted 56-SIF10-AST

Light Colored

\$.89



Tan 56-SIL11-TN  
Green 56-SIL11-GN  
Pink 56-SIL11-PK  
Maroon 56-SIL11-MN  
Assorted 56-SIL11-AST



# Soft Slip-In Cases

200 per case

Paisley Print Flip Top

\$1.29



Assorted 56-SIFT06-AST

Leatherette

\$1.04



Brown 56-SIL14-BN  
Black 56-SIL14-BK  
Assorted 56-SIL14-AST

Paisley Print

\$.89

Assorted 56-SIF02-AST



Light Colored

Half-Eye

\$.69



Black 56-SIHE01-BK  
Assorted 56-SIHE01-AST

Denim Flip Top

\$1.89

Assorted 56-SIFT08-AST



# Soft Slip-In Cases

200 per case

Croc  
Medium  
\$.89



Assorted 56-SIC04-AST

Croc  
Medium  
\$.69



Assorted 56-SIL09-AST

Leatherette  
Medium  
\$.69



Black 56-SIL03-BK  
Assorted 56-SIL03-AST

Leatherette  
Half-Eye  
\$.59



Black 56-SIHE01-BK  
Assorted 56-SIHE01-AST

Leatherette Flip Top  
Medium  
\$1.09



Black 56-SIFT02-BK  
Assorted 56-SIFT02-AST

Leatherette Clip  
Medium  
\$.79



Black 56-SIC03-BK  
Assorted 56-SIC03-AST

Leatherette Clip  
Medium  
\$.79



Black 56-SIC01-BK  
Assorted 56-SIC01-AST

# Plastic Cases

100 per case



Snap Closure Plastic  
Medium Kids Case  
\$.79  
Assorted 56-P1-AST



Frosted Plastic  
Medium Kids Case  
\$.89  
Assorted 56-P3-AST



Transparent Plastic  
Medium Kids Case  
\$.79  
Assorted 56-P4-AST



Frosted Plastic  
Medium Kids Case  
\$.79  
Assorted 56-P5-AST



Basic Classic  
Medium  
\$.89  
Assorted 56-P7-AST



Basic Classic  
Medium  
\$.89  
Assorted 56-P6-AST

CHEMISTRY

MACHINERY

EDGING

SURFACING

TOOLS

FRAME PARTS

EXAM SUPPLIES

ACCESSORIES

LENS CLEANERS



ACCESSORIES

# Eyewear Retainers

Welcome to OptiSource's new eclectic selection of eyewear retainers. Our collection offers a variety to from basic strings, to New York City designer collections to suit all customers. Each piece is individually packaged and includes a paperboard hang tab. All retainers are sold individually.

See pages 174-181



Two sided display with six metal pegs each side. Holds 48 retainers.

95-217 \$47.49



Hootie - Silver 42-OSCAHS \$5.79



Round Town 42-OSCARTS \$4.99



Link and Flower 42-OSCALFS \$3.99



Ornamental - Silver 42-OSCBOS \$5.99



Dazzle 42-OSCADS \$3.99



Ornamental Gold 42-OSCBOG \$5.99















Safari 42-OSCASS \$3.99



Golden Flower 42-OSCALFG \$3.99



	Golden Beads	42-OS CABG	\$3.99
	Herringwish	42-OS CAHG	\$3.29
	Classic Gold	42-OS CACG	\$3.29
	Silver Beads	42-OS CABS	\$3.99
	Mamba - Gunmetal	42-OS CMBG	\$2.99
	Mamba - Silver	42-OS CMBS	\$2.99
	Everlink - Gold	42-OS CELGD	\$3.99
	Everlink - Gunmetal	42-OS CELGM	\$3.99
	Finity - Gunmetal	42-OS CFGM	\$2.49
	Finity - Gold	42-OS CFGD	\$2.49
	Carlin Beads	42-OS CCRB	\$2.99
	Petite - Pink	42-OS CBPI	\$5.99
	Petite - Silver	42-OS CBPSI	\$5.99

CHEMISTRY

MACHINERY

EDGING

SURFACING

TOOLS

FRAME PARTS

EXAM SUPPLIES

ACCESSORIES

LENS CLEANERS

# ACCESSORIES

	Colored Pearl Rosary	42-CMC22259	\$10.00
	Animal Stripe	42-CMC22305	\$10.00
	Starkitect	42-CMC22245	\$10.00
	Faceted Copper	42-CMC22333	\$10.00
	Rosary Tortoise	42-CMC58114	\$10.00
	Desert Sands	42-CMC22377	\$10.00
	Pearl Sensation - Peach	42-OSCBPSP	\$4.99
	Pearl Sensation - Copper	42-OSCBPSC	\$4.99
	Pearl Sensation - Green	42-OSCBPSG	\$4.99
	Midnight Splendor	42-OSCBMS	\$5.79
	Copper Twinkle	42-OSCBCT	\$5.49
	Aura	42-OSCAUR	\$3.49
	Asia	42-OSCASE	\$3.49
	Monarch	42-OSCMON	\$4.49





Gem Cut - Black 42-OSCBGCBK \$5.79



Iridescent Glass 42-OSCBIG \$4.99



Gem Cut - Bronze 42-OSCBGCBZ \$5.79



Jammin 42-OSCBJ \$4.99



Naturale 42-OSCBN \$4.99



Squaretones - Natural 42-OSCBSN \$5.79



Squaretones - Gray 42-OSCBSG \$5.79



Squaretones - Aqua 42-OSCBSA \$5.79



Belize - Emerald 42-OSCBLE \$5.49



Belize - Tawni 42-OSCBLT \$5.49



Belize - Lavender 42-OSCBLL \$5.49

ACCESSORIES

Octa Necklace Holder  
42-OSHAON  
\$5.39

Earthy Necklace Holder - Ivory  
42-OSHBENI  
\$3.79

Earthy Necklace Holder - Brown  
42-OSHBENB  
\$3.79

Angelica Necklace Holder  
42-OSHANG  
\$5.99





Sophia Necklace Holder  
42-OSHSOPH  
\$4.49

Butterfly Necklace Holder  
42-OSCATNB  
\$3.99

Square Necklace Holder  
42-OSCATNS  
\$3.99

Petals Necklace Holder  
42-OSCATNP  
\$3.99

Flower Necklace Holder  
42-OSCATNF  
\$3.99



CHEMISTRY

MACHINERY

EDGING

SURFACING

TOOLS

FRAME PARTS

EXAM SUPPLIES

ACCESSORIES

LENS CLEANERS

# ACCESSORIES



Optistrap Neoprene - Blue 42-OSPBLUE \$1.99



Optistrap Neoprene - Green 42-OSPGREEN \$1.99



Optistrap Neoprene - Yellow 42-OSPYELLOW \$1.99



Optistrap Neoprene - Black 42-OSPBLACK \$1.99



Optistrap Neoprene - Red 42-OSPREL \$1.99



Opticord - Brown 42-OCDBROWN \$1.69



Opticord - Navy 42-OCDNAVY \$1.69



Opticord - Burgundy 42-OCDBURGUNDY \$1.69



Opticord - Black 42-OCDBLACK \$1.69



Flat Sewn Nappa Leather - Natural 99-OCFSNN \$3.79



Flat Sewn Nappa Leather - Rust 99-OCFSNR \$3.79



Flat Sewn Suede - Black 99-OCFSSB \$3.79



Flat Sewn Suede - Choco Brown 99-OCFSSCB \$3.79



Braided Leather - Choco Brown 99-OCBLCB \$4.49



Braided Leather - Natural/Brown 99-OCBLNB \$4.49



Optistring - Brown 42-OSGBROWN \$0.99



Optistring - Green 42-OSGGREEN \$0.99



Optistring - Black 42-OSGBLACK \$0.99



Optistring - Navy 42-OSGNAVY \$0.99



Optistring - Purple 42-OSGPURPLE \$0.99



Funtime - Green 42-OSCBFG \$0.99



Funtime - Soft Pink 42-OSCBFSP \$0.99



Funtime - Orange 42-OSCBFO \$0.99



Funtime - Purple 42-OSCBFP \$0.99



Funtime - Hot Pink 42-OSCBFHP \$0.99



Funtime - Blue 42-OSCBFB \$0.99

# Cablz

The Cablz patented design keeps retainers off of your neck for a more comfortable wearing experience. The surgical steel or monofilament designs are feather light, and the exclusive rubber ends grip tight and will not melt or stain. Offer the brand that patients demand - Original Cablz.

## Cablz Classic

Black	30-CABLZBK
Monoz	30-CABLZMONO
Stainless	30-CABLZSTNLS
Black XL	30-CABLZBKXL
Monoz XL	30-CABLZMONOXL
Stainless XL	30-CABLZSTNLSXL

\$6.50 each



Display 30-CABLZDISPL \$28.00

Zipz takes Cablz and Monoz to the next level. By adding infinitely adjustable sliders. They can be worn at regular length or adjusted for a closer fit to the back of the head.

## Cablz Zipz

Black	30-CABLZBKZ
Monoz	30-CABLZMONOZ
Stainless	30-CABLZSTNLSZ

\$7.50 each





# HAVEN

## FITS OVER SUNWEAR™

OPTIFY™  
LENS TECHNOLOGY

- Polarized to reduce glare
- Hardcoat offers 2X more scratch resistance than coating on ordinary sunglasses
- Oleophobic coating repels water, oil and smudges

- Lightweight, nylon frame
- **BendToFit®** temples on most styles
- Lenses block 100% UVA/UVB

- Over the glass protection
- Polarized
- Water Repellent
- Anti-Smudge
- Tough Coat

## Fits Over Sunwear

**\$14.99**  
each

### Fashion Collection

Contemporary styling without side lenses



**Avalon**  
Fits over Rx glasses not exceeding  
5-1/2"W x 1-1/4"H



**Solana**  
Fits over Rx glasses not exceeding  
5-1/2"W x 1-1/4"H



**Sunset**  
Fits over Rx glasses not exceeding  
5-3/8"W x 1-5/8"H



**Balboa**  
Fits over Rx glasses not exceeding  
5-3/8"W x 1-5/8"H

Avalon	Gloss Black Frame - Gray Lens	53-3HG2690S
	Tort Frame - Amber Lens	53-3HG2653ST
	White Frame - Gray Lens	53-3HG2660S
Sunset	Mocha Frame - Amber Lens	53-3HC643S
	Tort Frame - Amber Lens	53-3HC653ST
	Midnight Blue Frame - Gray Lens	53-3HC620S
Solana	Gloss Black Frame - Gray Lens	53-3HG690S
	Midnight Blue Frame - Gray Lens	53-3HG620S
	Tort Frame - Amber Lens	53-3HG653ST
Balboa	Gloss Black Frame - Gray Lens	53-3HK690S
	Gloss Wine Frame - Gray Lens	53-3HK6W0S
	Tort Frame - Amber Lens	53-3HK653ST

### Classic Collection

Traditional shapes provide optimal coverage



**Summerwood**  
Fits over Rx glasses not exceeding  
5-3/8"W x 1-7/8"H



**Windemere**  
Fits over Rx glasses not exceeding  
5-1/2"W x 1-1/4"H



**Meridian**  
Fits over Rx glasses not exceeding  
5-1/4"W x 1-1/2"H



**Banyan**  
Fits over Rx glasses not exceeding  
5-1/2"W x 1-1/4"H

Summerwood	Black Frame - Gray Lens	53-3H4600S
	Black Frame - Yellow Lens	53-3H4607S
	Matte Tort Frame - Amber Lens	53-3H46543ST
	Tort Frame - Amber Lens	53-3H4653ST
Meridian	Black Frame - Gray Lens	53-3H5600S
	Black Frame - Yellow Lens	53-3H5607S
	Tort Frame - Amber Lens	53-3H5653ST
Windemere	Black Frame - Gray Lens	53-3H2W600S
	Tort Frame - Amber Lens	53-3H2W653ST
Banyan	Black Frame - Gray Lens	53-3H3600S
	Matte Tort Frame - Driving Lens	53-3H36543ST

## Panorama Collection

Wrap-around lenses allow for maximum peripheral view



Tolosa

Fits over Rx glasses not exceeding  
5-1/2"W x 1-1/2"H



Malloy

Fits over Rx glasses not exceeding  
5-1/3"W x 1-1/3"H



Foxen

Fits over Rx glasses not exceeding  
5-1/2"W x 1-1/4"H



Hunter

Fits over Rx glasses not exceeding  
5-5/8"W x 1-5/8"H

Tolosa	Black Frame - Gray Lens	53-3HRT600S
	Tort Frame - Amber Lens	53-3HRT653ST
Foxen	Black Frame - Gray Lens	53-3HRN600S
	Midnight Blue Frame - Gray Lens	53-3HRN620S
	Tort Frame - Amber Lens	53-3HRN653ST
Malloy	Black Frame - Gray Lens	53-3HRM600S
	Tort Frame - Amber Lens	53-3HRM653ST
Hunter	Black Frame - Gray Lens	53-3HRH600S
	Matte Tort Frame - Amber Lens	53-3HRH6543ST
	Tort Frame - Amber Lens	53-3HRH653ST

## Sport Collection

Vented frame helps reduce fogging



Rainer

Fits over Rx glasses not exceeding  
5-1/2"W x 1-1/2"H



Biscayne

Fits over Rx glasses not exceeding  
5-1/3"W x 1-1/3"H



Denali

Fits over Rx glasses not exceeding  
5-1/2"W x 1-1/4"H



Everest

Fits over Rx glasses not exceeding  
5-5/8"W x 1-5/8"H

Rainer	Soft Touch Black Frame - Gray Lens	53-3HX600S
	Tort Frame - Amber Lens	53-3HX653ST
Denali	Matte Tort Frame - Amber Lens	53-3HW116543ST
	Soft Touch Black Frame - Gray Lens	53-3HW11600S
Biscayne	Soft Touch Black Frame - Gray Lens	53-3HY600S
	Tort Frame - Amber Lens	53-3HY653ST
Everest	Black Frame - Gray Lens	53-3HXX600S
	Tort Frame - Amber Lens	53-3HXX653ST

## Lens Options



YELLOW  
(Available on Classic only.)



GRAY



AMBER

## Displays



18 Piece Floor Display with Glasses

53-17P208DHNO-F \$469.63

6 Piece Countertop Display with Glasses

53-17P204DHNO-F \$139.87



# Signature Fits Over Sunwear

High Fashion Sunglass Collection

- Optical grade polarized lens technology with zero friction surface
- BendToFit™ Temples

**\$19.99**  
each

## FREESIA 1

Chocolate Frame, Amber Lens

The Freesia 1's urban jungle flair draws from its croc skin temple embellishments, sleek rectangular shape and rich chocolate brown finish.



## FREESIA 2

Gloss Black Frame, Gray Lens

The Freesia 2 has an understated elegance fashioned by 2 silver bars and a lustrous black finish within a slim and contemporary rectangular shape.



## DAHLIA 1

Gloss Black Frame, Gray Lens

The Dahlia 1 is reminiscent of the night sky - sophisticated and dazzling! Dozens of tiny crystals sparkle against a rich glossy black frame.



## DAHLIA 2

Gloss Black Frame, Gray Lens

The Dahlia 2 combines wild with the stylish joining a distinctive leopard print and a gold medallion.



Freesia-1	Chocolate Frame	Amber Lens	53-3HSD116E3S1
Freesia-2	Gloss Black Frame	Grey Lens	53-3HSD11690S1

Dahlia-1	Gloss Black Frame	Grey Lens	53-3HSG11690S1
Dahlia-2	Gloss Black Frame	Grey Lens	53-3HSG11690SY

# 3D Over Glasses and Clip-ons

The challenge for prescription eyewear users to find comfortable Passive 3D glasses has been solved. Our 3D over glasses and flip-up clip-ons provide a super comfortable and convenient choice for your patients to fully enjoy a 3D movie.

- Compatible with Passive 3D devices and RealD® movie theaters
- Over glass style available in two sizes
- Flip-up clip-ons available in two styles



Medium: 5.5"(Inside W) x 1.7"(Outside H)  
Large: 5.5" x 1.75"

Medium	99-269-1	\$14.99
Large	99-269-2	\$14.99



Rimless flip-up clip-on  
5"W X 1.6"H



Fully framed flip-up clip-on  
5.4" x 1.5"H

Rimless	99-269-3	\$5.99
Fully Framed	99-269-4	\$8.99



Display	99-269-5	\$39.99
---------	----------	---------





\$16.95 each



# Dry Eye Relief Sunglasses

The Dual Layer Foam Gasket Provides a Barrier to the Eyes for Patients with Sensitivities from Dry eyes, Allergies, Dust, Wind and Extreme Bright Light. Frame and lenses provide 50% more protection from sun and elements than conventional sunglasses.

- Comfortable dual layer foam gasket helps retain moisture around the eye
- Designed to accommodate patients' own prescription lenses
- BendToFit™ temples
- Lenses block 100% UVA and UVB light
- Scratch resistant polycarbonate lenses
- Anti-fog lens coating
- Rx-able by your lab



Black Frame/Smoke Lens  
Tortoise Frame/Copper Lens



6 Piece Countertop Display with Glasses  
53-17P204DESZ-F \$134.99



### Medium Modified Rectangle

Black/Smoke	53-5FX359SF2A
Tortoise/Copper	53-5FX355F2TA



### Large Modified Rectangle

Black/Smoke	53-5FX559SF2A
Tortoise/Copper	53-5FX5555F2TA



### Large Square

Black/Smoke	53-5F559SF2A
Tortoise/Copper	53-5F55555F2TA



### Extra Large Square

Black/Smoke	53-5F5659SF2A
Tortoise/Copper	53-5F56555F2TA



### Medium Oval

Black/Smoke	53-5FS0500SF2A
Tortoise/Copper	53-5FS0555F2TA



### Medium Large Rectangle

Black/Smoke	53-5F1050SF2A
Tortoise/Copper	53-5F10555F2TA

# Low Vision Aids



## Magnifiers

COIL is recognized as a world leader in precision low-vision products with more than 65 years of experience serving the ophthalmic market. Throughout this period, COIL has researched, developed, and manufactured low-vision aid magnifiers and created one of the most comprehensive product ranges available.



## COIL Illuminated Raylite Magnifiers

These optical-quality acrylic lenses contain a maintenance-free sealed LED light and easy-to-replace batteries. Also available as an electric handle with a transformer. Multiple heads available with various power/dieters and lens sizes.



Incandescent Battery Raylite



Xenon-Battery Raylite



Xenon Transformer Raylite



LED Battery Raylite

## Non-Illuminated Hand-Held Magnifiers

These lightweight magnifiers offer a high quality acrylic, distortion-free lens. Its long handle is easy to hold and has a hole in the end that can accommodate a holder cord.



Item	Power	Lens Size	Price
35-454639	3x	3"x4" Rectangle	\$32.35
35-454616	5x	2.5" Round	\$12.91
35-454617	7x	2" Round	\$11.83
35-454668	(3x rec., 5x, 7x) Set of 3		\$43.15

## Distortion-Free Magnifier



Donegan's distortion free, optical acrylic lens ensures sharp focusing to the edge of the lens. It has a large, easy-to-hold handle.

Item	Power	Lens Size	Price
35-VMA21	5x	2.5" Round	\$33.43
35-VMA23	3x	2"x4" Rectangle	\$48.55

## Zelco 3x Lumifier Pocket Magnifier

To open the lens, simply press and hold the large release button. The lens will rotate out of the housing with a smooth hydraulic pivot action. Release the button when lens has rotated to desired position. It contains two super bright white LED lights; one follows the lens when it is opened and the second LED light functions as a flashlight when lens is in the stored position. Measures 1.7 x 5 x 0.9 inches. Requires two lithium CR2032 batteries (included).

Item	Power	Price
35-570288	3x	\$31.32



## ZELCO Lumifier Handstand

The Lumifier Handstand is an LED lit, optical grade 3x magnifying lens with a 5x "sweet spot" for fine detail work. It has a protective rubber body that is very comfortable to hold. If you need to free up your hands, flip out the metal leg and the Lumifier Handstand will stand on its own. The flexible neck allows the lens to bend to countless positions. Measures 4.2 x 9.75 x 0.8 inches. Requires 3 "AAA" batteries



Item	Power	Price
35-570286	3x	\$13.78
35-570287	5x	\$43.20

## 3x ZELCO FLX Tabletop Lumifier with 5x bifocal

This high quality, optical grade, 3x magnifying lens with a 4" diameter is ideal for both optical professionals during frame assembly, repair, or adjustment as well as for patients for reading, sewing, arts, and crafts. The base is weighted for stability and armored in rubber for protection. The soft touch switch illuminates the three super bright, cool white LED bulbs. Requires 4 "AA" batteries.



Item	Power	Price
35-570285	3x	\$52.92

## Round Illuminated Magnifiers



The combination of illumination, high magnification, and compact size makes this 4x magnifier an exceptionally useful aid to carry in one's pocket, briefcase or purse. It comes with a black plastic carrying case. Requires 2 "AA" batteries.

Item	Power	Lens Size	Price
35-328125	4x	1.75"	\$7.51
35-328225	5x	1.25"	\$7.51
35-328325	6x	1.00"	\$7.51



## ACCESSORIES



### 3x Designer Folding Reading Magnifier With LED Light

For patients who prefer rectangular magnifiers, this elegant LED is the right choice. Its easy-to-hold handle folds flat against the lightweight silver-tone frame, and fits neatly into its included protective pouch. Lens size measures 3.5" x 2.5". Includes one 'AAA' battery.

Item	Power	Lens Size	Price
35-454382	3x	2"x4"	\$26.95

### Classic Black Hand-Held Magnifiers



Lightweight black plastic frames with high quality aspheric lens.

Rectangle (Includes a protective case)

Item	Power	Lens Size	Price
35-5449	2.4x	4"x3"	\$61.06
35-5438	2.5x	3.3"x2.5	\$54.02
35-5432	3.5x	2.5"x2	\$39.85

Round (Includes a protective case)

Item	Power	Lens Size	Price
35-5460	5.4x	1.9"	\$42.89

COIL

Item	Power	Lens Size	Price
35-5442	2.8x	3.7"	\$61.06
35-5798	4.7x	2"	\$24.31

## LED-Illuminated Stand Magnifiers

Our LED magnifiers are high quality, affordable aids that makes looking at mail, images, books, etc. much easier. The lens is housed in an easy-to-operate handle that is designed to keep the lens in focus when the frame is resting on the book. This lens presents a large viewing area with the ability to tilt the lens toward you so you don't need to be directly over the lens to see clearly. The bulbs last approximately 10,000 hours. Requires 3 "AA" batteries.



Item	Power	Lens Size	Price
35-905104	3x	4"X3"	\$52.87
35-905106	3x	4"X2"	\$52.87
35-905100	4x	2.7"	\$37.75
35-905105	5x	2.4"	\$37.75
35-905108	6x	2.25"	\$37.75
35-905101	7x	1.9"	\$37.75
35-905102	8x	1.4"	\$37.75
35-905103	10x	1.4"	\$37.75

## LED Illuminated Hand-Held Magnifiers

These first-quality, lightweight magnifiers provide the perfect balance of quality and value. The body and slide switch are durable and comfortable.



Item	Power	Lens Size	Price
35-905209	3x	3"x2" rectangle	\$40.99
35-905207	3.5x	3"x2" rectangle	\$40.99
35-905205	4x	2.7"	\$32.35
35-905206	5x	2.4"	\$32.35
35-905208	6x	2.2"	\$32.35
35-905200	7x	1.9"	\$32.35
35-905201	8x	1.4"	\$32.35
35-905202	10x	1.4"	\$32.35
35-905203	12x	1.4"	\$32.35
35-905204	14x	1.4"	\$32.35

## COIL Visual Tracking Magnifiers

COILS's Visual Tracking Magnifiers (VTMs) have been specifically designed to aid patients suffering from Dyslexia or similar reading difficulties. The VTMs help patients to concentrate their vision on individual words or sentences and remove the confusion caused by nearby text or pictures.



Item	Power	Lens Size	Price
35-5850/12	1.7x	2" Round/Red	\$37.75
35-5850/13	1.7x	2" Round/Blue	\$37.75
35-5850/02	4.4x	2" Round/Clear	\$50.76
35-5850/22	1.5x	1.5"x.75" Bar/Red	\$42.07
35-5850/23	1.5x	1.5"x.75" Bar/Blue	\$42.07

## Globe Magnifiers

Round 1.7x magnifier measure 2" in diameter. It has durable, soft touch grips to grasp and move across the page. Protective lens caps are included.



Item	Power	Lens Size	Price
35-5850	1.7x	2"	\$24.79

## 3M Press-On

\$19.99 each



Item	Power	Code
------	-------	------

### Press-On Aspheric Lenses

+0.5D	08-3M495284
+1.0D	08-3M495292
+1.5D	08-3M495227
+2.0D	08-3M495235
+2.5D	08-3M495243
+3.0D	08-3M657818
+3.5D	08-3M495185
+4.0D	08-3M495193
+5.0D	08-3M657800
+6.0D	08-3M495219
+7.0D	08-3M495144
+8.0D	08-3M495151
+10.0D	08-3M495169
+12.0D	08-3M495177
+14.0D	08-3M495060
+16.0D	08-3M495078
-1.0D	08-3M495086
-2.0D	08-3M495094
-3.0D	08-3M495029
-4.0D	08-3M495037
-5.0D	08-3M495045
-6.0D	08-3M495052
-7.0D	08-3M494980
-8.0D	08-3M494998
-9.0D	08-3M495003
-10.0D	08-3M495011
-11.0D	08-3M494949
-12.0D	08-3M494956
-13.0D	08-3M494964
-14.0D	08-3M494972

### Press-On D-25 Segs

+1.0D	08-3M495102
+1.5D	08-3M495110
+2.0D	08-3M495128
+2.5D	08-3M495136
+3.0D	08-3M495425
+4.0D	08-3M495433
+5.0D	08-3M495441
+6.0D	08-3M495458

### Press-On Prisms

1.0D	08-3M495383
2.0D	08-3M495391
3.0D	08-3M495409
4.0D	08-3M495417
5.0D	08-3M495342
6.0D	08-3M495359
7.0D	08-3M495367
8.0D	08-3M495375
9.0D	08-3M653700
10.0D	08-3M495300
12.0D	08-3M495318
15.0D	08-3M495326
20.0D	08-3M495334
25.0D	08-3M495268
30.0D	08-3M495276
35.0D	08-3M657784
40.0D	08-3M657792

# Contact Lens Cases

## Sunglass Flat Packs

19¢  
each

Who said we couldn't make flat packs cool? Our rockin' design is the first innovation to flat packs in decades. The living hinge snaps securely to the base with a double lock system to ensure leak-free performance. The raised star wells make retrieving lenses simple.

- Exclusive design
- Available in four popular colors
- Sold in bags of 100



Assorted	74-705
Black	74-704
Red	74-703
Blue	74-702
White	74-701

## Flip-Top Flat Packs

19¢  
each

Our Extra-Deep-Well Flat Packs Feature a Double Hinge Lock Design

Lids snap shut and won't pop open. Ribbed wells allow for maximum lens wetting. Reinforced hinges won't tear or crack.

- Exclusive dual seal in the cap to help prevent leakage
- Reinforced hinge at the lid and base to help reduce tearing
- Imprinting available (1,000 minimum)
- Ribbed well design
- Sold in packages of 100

Assorted	57-1050A
Yellow	57-1050Y
Green	57-1050G
Pink	57-1050P
Clear	57-1050C
White	57-1050W
Blue	57-1050B





## Leather Cases

This genuine leather case is the stylish way to carry contact lenses. It snugly holds our leak-free screw top contact lens case which has a convenient mirror inside.

- Twelve designs to choose from
- Leak-proof screw top contact lens case
- CE & FDA approved
- Free display with 12 piece purchase



Empty Display 74-613 \$1.99



**\$6.99**  
each

Solid	
White	74-603
Black	74-604
Lime Green	74-602
Pink	74-601
Navy	74-606
Burgundy	74-605



**\$7.99**  
each

Patterns	
Autumn Harvest	74-611
Tartan Plaid	74-612
Green Retro	74-608
Pink Floral	74-607
Blue Star	74-610
Natural Leaf	74-609

## Bubble Cases

\$4.99  
each

Bring fun and variety to your contact lens patients with these unique and colorful designs. Each bubble case includes a standard screw top contact lens case, a practical mirror in the lid, and a 'name and address' card.

- Available in 24 different designs
- Display free with purchase of 12 pieces

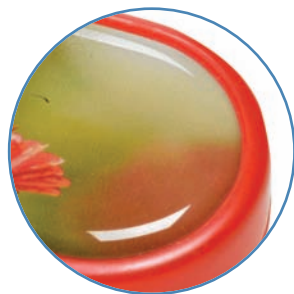

Raised bubble label

Puppies	74-111
Piglets	74-110
Kittens	74-107
Butterfly	74-108
Red Hearts	74-115
Clownfish	74-109
Zebra Stripe	74-112
Giraffe Print	74-114
Cheetah Print	74-113
Multicolor Hearts	74-116
Green Circles	74-122
Black Plaid	74-121



Empty Display 74-125 \$1.99





# Bubble Cases



Soccer	74-106
Football	74-104
Baseball	74-101
Hockey	74-103
Golf	74-105
Basketball	74-102
Leaves	74-118
Mountains	74-119
Flowers	74-117
Camo	74-120
Pirate	74-123
American Flag	74-124



Empty Display 74-125 \$1.99





## Soft Grip Cases

\$1.99  
each

The functional and creative design which has taken conventional contact lens cases to a new dimension. Ergonomically designed cases feature smooth-surface locking caps with leak-proof closures.

- Anti-slip rubber base
- Available in 4 different color combinations
- Display free with 24 pieces

Yellow Blue	74-201
Orange Blue	74-202
Orange Purple	74-204
Yellow Purple	74-203



Empty Display 74-205 3.99

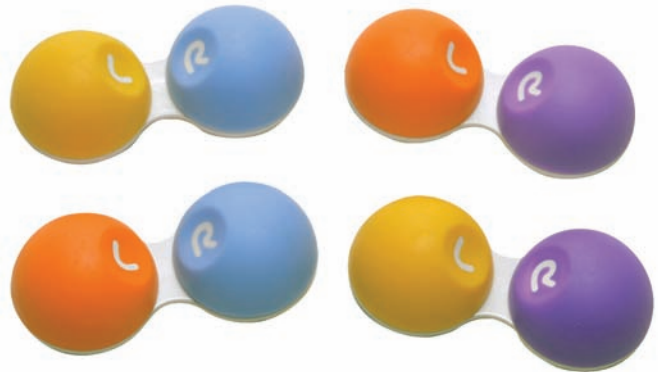

## Travel Kit

The hard plastic travel kit securely holds our Soft Grip contact lens case for travel. It includes a Soft Grip case, pair of plastic tweezers, and a glass mirror in the lid.

Note, it is never recommended to transfer contact lens solution from its original container to another container.

74-301 \$4.99



## DigiCase Cases

\$7.99  
each

The revolutionary and easy to use contact lens case has a 14 and 30 day digital timer built in. The timer prevents patients from over-wearing lenses and keeps their eyes healthy. The sleek, shiny case features a signature chrome band, a glass mirror in the lid, and an LCD screen.

- Digital timer reminder built in
- Leak-proof screw top contact lens case
- CE & FDA approved
- Free display with 12 piece purchase

Black	74-501
Green	74-502
Pink	74-503
White	74-504



Empty Display 74-505 3.99



## Dial-a-Date Cases

\$2.99  
each

A dial on each lid allows patients to set a date to remind them when their disposable lens need to be replaced. For example: your patient wears biweekly disposable lens on March 7th. They would set the Left lid to "2" and the Right lid to "1" lid, indicating the 21st of the month

- Distinctive L and R markings on both of the lids and base ensure the lenses are correctly organized
- Soft rubber around the lids provides a smooth and slip-free grip to ensure easily opening and closing
- Anti-slip bottom base
- Leak-proof design features secure locking lids and base

Yellow Purple	74-402
Orange Blue	74-401



# Frame Displays

Wood and Metal Tower



95-201 \$78.49

Tri-Spoke Swivel Display

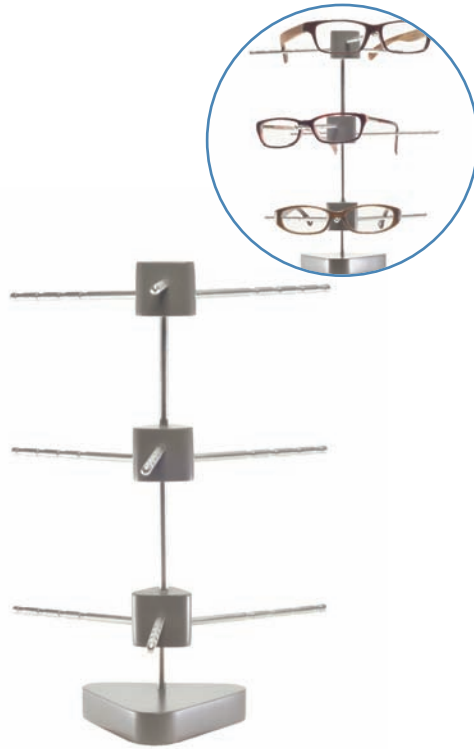

95-202 \$41.49

Four Frame Square Bar



95-203 \$44.99

Acrylic Panel



White Accent  
95-204 \$31.49



Black Accent  
95-205 \$31.49

Four Frame Tilted Panel



95-206 \$39.99

Five Frame Rod



95-207 \$16.99



Three Frame Rod



95-208 \$12.99

Acrylic Block



Clear  
95-209 \$11.49



Gray  
95-210 \$11.49

Invisible Display



95-211 \$49.99

Tiered Frame Riser



3 Tier 95-212 \$11.99  
4 Tier 95-213 \$15.99

Wave Display



3 Tier 95-214 \$15.99  
5 Tier 95-215 \$19.99

Wood and Acrylic Panel



95-216 \$35.49

## Mirrors

### Oval Mirror with Swivel Magnified Inset

- 17" tall
- 8" x 12" oval mirror with 4" inset mirror
- 1x magnification in main mirror
- 3x and 8x magnification in inset mirror
- Chrome finish

99-894-4      \$89.99



### Large Oval

- 19" tall
- 10 1/2" x 15" oval mirror
- 1x magnification
- Brushed stainless steel finish

99-251-1      \$74.99



### Two-Sided Top Swivel 1x and 5x

- 5 1/4" mirror
- 11 1/4" tall
- 5x and 1x magnification
- Satin nickel finish

99-894-1      \$34.99

### Two-Sided Bottom Swivel

- Twin - 6 1/2" mirror
- 12 1/2" tall
- Dual sided mirror
- 5x and 1x magnification
- Satin nickel finish

99-894-2      \$29.99



### Two-Sided Acrylic 1x and 5x

- 6 1/4" mirror
- 8 1/2" tall
- 5x and 1x magnification
- Made In USA

99-894-3      \$29.99



## Handle Mirror

- 8" x 10", 4" deep base
- Side handle design prevents fingerprints on mirror
- Fixed angle for counter viewing



White	95-100	\$29.99
Charcoal	95-101	\$29.99

## Dispensary Pro Mirror

- Heavy weight base and aluminum posts
- Smooth tilting action
- 12" x 14", 5" deep base



95-104	\$64.99
--------	---------

## Two-Sided Classic Oval 1x and 3x

- 15" tall
- 8"  $\frac{3}{4}$ " x 5"  $\frac{1}{2}$ "
- Satin nickel finish



95-102	\$54.99
--------	---------

## Picture Frame

- Glossy bold frame
- Smooth tilting action
- 10"  $\frac{3}{4}$ " x 10"  $\frac{3}{4}$ ", 3" deep base



95-103	\$36.99
--------	---------





## Head Displays

\$24.99  
each

Half the space, all the display! The Half Head displays are a new way to showcase your frame lines. They are stackable and interchangeable with three different colors.



Black	99-247-1
Silver	99-247-2
White	99-247-3



## Auto Visor Clips

\$1.39  
each

Never sit on, lose or damage your eyewear again. Our Visor Clips mount to any automobile visor or strap and securely hold your glasses. Also they work great on golf bags, purses or any carry bags with a shoulder strap.

Black	99-VISORBLACK
Blue	99-VISORBLUE
Red	99-VISORRED
Silver	99-VISORSILVER

## Leather Dispensary Tray



Present patients' glasses in a manner that conveys the quality of the eyewear you produced for them. Our premium leather dispensing case includes three velvet lined compartments. The closed box boasts a bold, hand stitched finish. When opened, the lid folds into a personal try-on mirror.

- High-end leather finish
- Velvet lined
- Lid folds to display mirror
- Extra-large compartment for oversized eyeglass cases
- Three compartments for glasses, clips/sunglasses, and case
- Measures: 10" x 7.5" x 2.5"

99-PRESTRAY2 \$49.99

## Wood Dispensary Tray

Impress Your Patients with This Fashionable Dispensary Tray

Our wood-finish dispensing is great during frame selection to hold potential frames, as well as presentation tray for finished eyewear.

- Three compartments
- Black wood finish
- Satin lined compartments
- Measures: 10" x 7" x 2.25"

99-PRESTRAY \$24.99



# Retail Bags

## Plastic Bags



These optical-themed bags are made of durable plastic with a die-cut reinforced handle for easy carrying.

- Four unique optical designs (one side print)
- Large bag size: 12" x 16"
- Small bag size: 8" x 12"
- 100 bags per case



Eye Chart

Our Focus

See You

Thank You

**\$15.99**  
100 bags

Large

- 64-CHART-LG
- 64-FOCUS-LG
- 64-SEEU-LG
- 64-THANKYOU-LG

**\$9.99**  
100 bags

Small

- 64-CHART-SM
- 64-FOCUS-SM
- 64-SEEU-SM
- 64-THANKYOU-SM

## Non-Woven Bags

**\$69.99**  
100 bags

Eco-friendly and economical bags offer unparalleled sturdiness and durability.

- 100% recyclable
- Reusable and hand washable
- 7 1/2" x 7" x 4"
- 100 bags per case



99-43-1

## Boutique Paper Bags

**\$69.99**  
100 bags

European style bags with a high gloss finish are sure to provide elegance to your customers' purchase. The paper bags feature a reinforced folded top with a twisted rope handle and paperboard bottom for stability.

- Two different styles: eyeglass design and plain white
- 8" x 7" x 4"
- 100 bags per case



99-264-1



99-264-2



A close-up photograph of a person in a white lab coat pouring a clear liquid from a beaker into a funnel that is placed over a round-bottom flask. The person's face is partially visible in the background, looking intently at the glassware. The scene is set in a laboratory environment with soft lighting.

# LENS CLEANERS

Keen on Clean

Whether you sell it, give it away, use it during assembly or dispensing, lens cleaner is an essential eyewear product. Our lens cleaner solutions are formulated with safe chemistry that provides efficient, streak-free cleaning and instant drying on all lenses and coatings. Our clever and unique packaging components embody quality lens cleaner. We weave our microfiber fabrics with the ideal blend of nylon and polyester to produce cleaning cloths that trap dust, absorb oils, and buff lenses to a brilliant shine. With our continuous expansion of lens cleaner and cloth options, OptiSource is truly committed to being Keen on Clean.

# Clear View Lens Cleaner

Clear View has been a trusted brand in premium lens cleaners for over twenty years. The mild formula is proven to be safe and effective on all lenses and coatings.

- Safe on AR coatings
- Anti-static
- Anti-streak

Item	Unit	Case Qty.	Code	Price Ea.
Unprinted	1 oz.	72	99-LC1-72	.79
Imprinted	1 oz.	72	99-LC1P-72	.84
Unprinted	2 oz.	72	99-LC2-72	.94
Imprinted	2 oz.	72	99-LC2P-72	.99
Unprinted	4 oz.	50	99-LC4-50	\$1.34
Imprinted	4 oz.	50	99-LC4P-50	\$1.39
Unprinted	8 oz.	24	99-LC8-24	\$1.69
Imprinted	8 oz.	24	99-LC8P-24	\$1.74

\* Two case minimum order for imprinting



1 oz.                      2 oz.                      4 oz.                      8 oz.

## Clear View Cleaning Kits

We've taken our popular Clear View lens cleaner and combined it with our top selling microfiber cloth. Choose from four packaging styles and optional imprinting on the cleaner and cloth.

- Four packaging options
- Imprinting available
- Optional keychain screwdriver available with drawstring bag or snap pouch kits

To order call customer service.



Optional 3-way keychain screwdriver



Silver Ribbon  
2 oz. only

Hang Tag  
2 oz. only

Drawstring Bag  
1 or 2 oz.

Snap Pouch  
1 or 2 oz.

# Wave Lens Cleaner



Our newest lens cleaner label maximizes your imprint visibility. The contemporary design is available in four vibrant colors and is sure to be a new favorite among patients.

- Clear lens cleaner formula
- Large imprint area
- Safe on all lenses and coatings

Item	Unit	Case Qty.	Code	Price Ea.
Unprinted	1 oz.	72	99-LCW1-72	.79
Imprinted	1 oz.	72	99-LCW1P-72	.84
Unprinted	2 oz.	72	99-LCW2-72	.94
Imprinted	2 oz.	72	99-LCW2P-72	.99
Unprinted	4 oz.	50	99-LCW4-50	\$1.34
Imprinted	4 oz.	50	99-LCW4P-50	\$1.39
Unprinted	8 oz.	24	99-LCW8-24	\$1.69
Imprinted	8 oz.	24	99-LCW8P-24	\$1.74

\* Two case minimum order for imprinting



Purple

Orange

Blue

Green

Clear label front with wave colored background allows your imprint to stand out.

## Wave Cleaning Kits

Wave lens cleaner kits are available in any Wave label color from above. Pair it with a coordinating cloth color for maximum appeal (see page 212 for available cloth colors.)

- Four packaging options
- Imprinting available
- Add optional keychain screwdriver on to drawstring bag or snap pouch kits.

To order call customer service.



Optional 3-way keychain screwdriver



Silver Ribbon  
2 oz. only



Hang Tag  
2 oz. only



Drawstring Bag  
1 or 2 oz.



Snap Pouch  
1 or 2 oz.



# LENS CLEANERS



## Custom Bottle. Custom Color. Custom Label.

Our new Custom Clean offers the most versatile and customizable lens cleaner packaging in the industry. Custom Clean's flat bottle design is proven to be the most desirable shape for handling and storing in pockets and purses. Then, we offer the widest color range of lens cleaner liquids to choose from. Lastly, you can select from our hundreds of label design and color combinations.

### Choose the Lens Cleaner Color



Blue

Clear

Purple

Green

Ice

### Select from Hundreds of Label Designs and Colors



### Choose a Cloth

Want the sleekest lens cleaner Kit? Add a custom die-cut cloth in a plastic carrying case that sticks to the back of the Custom Clean bottle so it is always handy. The microfiber cloth features an embossed repeating pattern and rounded edges to compliment the elegance of the Custom Clean shape.



Cloth measures 6 x 3.5"

### Display



Holds 24 cleaners. Cleaners not included.  
Display free with order of 200 bottles.

99-LC3DISPLAY \$49.99

# Customize and Order Online

The technology behind Custom Clean happens online with our proprietary customization ordering engine. Magically watch your custom lens cleaner get built as you select colors, labels, imprinting type, and font colors. Make changes in real-time, upload logos, or choose from our cache of stock optical logos and icons. The ordering engine is intuitive and proven to be user-friendly to all levels of computer users.



Visit [1-800-OptiSource.com/Custom-Clean](http://1-800-OptiSource.com/Custom-Clean)

Quick Ship - In Stock and Ready to Go

**99¢**  
each

**\$1.79**  
each

Lens Cleaner

Purple	99-LC3SP
Blue	99-LC3SB
Green	99-LC3SG
Ice	99-LC3SI
Clear	99-LC3SC

Cleaner with Cloth (Kit)

Purple	99-LC3KSP
Blue	99-LC3KSB
Green	99-LC3KSG
Ice	99-LC3KSI
Clear	99-LC3KSC



For Customized Cleaner + \$0.05.  
Go online to order or call for assistance.

## LENS CLEANERS

### Lens Cleaner Refill

Refill customer or dispensary lens cleaner bottles.  
Choose from one gallon size or 2.5 gallon cubitainer with spigot.

- Available in clear or purple cleaner



#### Purple Cleaner

99-LCG	Gallon	\$24.99
99-LCD	2.5 Gallon	\$59.99

#### Clear Cleaner

99-LGC	Gallon	\$24.99
99-LCDC	2.5 Gallon	\$59.99

### Universal Lens Cleaner Display

Our acrylic universal lens cleaner display holds a variety of different style cleaners, kits, or cloths. Fill the display with your best selling lens care products.

- Small footprint: 13"L x 7 1/8"W x 6 1/4"H
- Holds a variety of cloths and cleaners



Products not included

47-LCDISPLAY	Each	\$39.99
--------------	------	---------

### Fog Free™ Anti-Fog Cleaner



Fog Free is a temporary defogging cleaner that is safe and effective on most lenses. (does not work on AR coatings.)

- Cleans and puts an anti-static charge on lens
- Works great on dive masks
- 72 bottles per box

99-LCFF	2 oz	\$1.59
99-LCFFG	Gallon	\$29.99

### Economy Squeeze Lens Cleaner



This 1oz. economy lens cleaner is ideal to use as a giveaway promotional item. The drip-top container dispenses drops of cleaner to the lens surface.

- Economy priced
- 50 bottles per case

Unprinted	47-LC1SQZ	Each	\$0.39
Imprinted	47-LC1SQZ-PL	Each	\$0.44

\* Two case minimum order for imprinting.



# Card Cleaner Kit

The credit card sized kit measures just 2 ¼" x 3 ¼" x ⅜". The super slim design allows the Card Cleaner Kit to fit discretely into pockets, purses, carrying cases, and anywhere else a round or bulky cleaner would not be desirable.

Includes:

- 20mL rectangular spray bottle of lens cleaner
- 6" x 5 ¾" silky microfiber cloth
- 25 assorted-color cleaner kits per box

97-CARDASST Each \$1.79

\* For imprinting add "PL" to the code + \$0.15.  
(Minimum 250 Pieces)  
Cloth not imprintable. Imprinting on case only.



# Luxury Cleaner Kit

We decided it's time to break the mold on lens cleaner design with the Luxury Cleaner Kit. The fashion-forward design is trendy, unique and sure to be a hit with your customers. The front of the cleaner is imprintable with your company's information.

Includes:

- 30mL oval bottle
- 7" x 6 ¾" designer pattern cloth with sewn edges
- 25 assorted-color cleaner kits per box

97-LUXASST Each \$2.29

\* For imprinting add "PL" to the code + \$0.15.  
(Minimum 250 Pieces)  
Cloth not imprintable. Imprinting on case only.



# LENS CLEANERS



## Rip Cord Microfiber Cloth In Pouch

99¢  
each

Rip Cord's handy design features our highest quality microfiber cloth, uniquely attached to a retractable cord that stashes in a neoprene case. The novel design and functionality is sure to be a hit with customers.

- Available in five color-coordinated styles: purple, blue, red, yellow, white
- Cloth is ideal size for cleaning glasses, camera lenses, electronics, and more
- Includes carabiner-style clip for easy attachment
- Imprinting available on the case
- Sold in packs of 100 per color

Purple	33-261-11
Blue	33-261-12
Red	33-261-13
Yellow	33-261-14
White	33-261-15

\* For imprinting add "PL" to the code + \$0.15.  
(Minimum order 500 cloths)



## Aktiv All-In-One Sporty, Compact Kit

Our new Aktiv lens cleaner is a cloth and cleaner, all-in-one sporty, compact kit. The refillable .33 oz. spray cleaner is AR safe, and fast-drying. The silky microfiber cloth is attached with a strap that retracts the cloth back into the Aktiv kit when pulled. A handy carabiner allows Aktiv to attach to any loop.

- Cloth and cleaner kit
- Refillable
- 24 kits per box



16 piece display.  
Cleaners not included.



97-LCSPORT	Each	\$2.59
97-LCSPORTDISPLAY	Each	\$24.99

Spray

Clean

Retract



# Kimberly-Clark® Disposable Wipes



Kimwipes EX-L 1 ply  
4.4" x 8.4"

Shown in pop-up  
dispenser box



Kimwipes EX-L 2 ply  
11.8" x 11.8"



Kimwipes EX-L 1 ply  
14.7" x 16.6"



Wypall heavy-duty wiper  
12.5" x 16.8"



Kaydry EX-L 2 ply  
15" x 16.8"

## By the Case

Kimwipes EX-L 1 Ply	15 Boxes	25-34256C	\$139.99
Kimwipes EX-L 1 Ply	60 Boxes	25-34155C	\$194.99
Kimwipes EX-L 2 Ply	15 Boxes	25-34705C	\$139.99
Kaydry EX-L 2 Ply	15 Boxes	25-34721C	\$189.99

## By the Box

Kimwipes EX-L 1 Ply	140 Wipes	25-34256	\$9.99
Kimwipes EX-L 1 Ply	280 Wipes	25-34155	\$3.99
Kimwipes EX-L 2 Ply	119 Wipes	25-34705	\$9.99
Kaydry EX-L 2 Ply	90 Wipes	25-34721	\$13.99
Wypall X60	180 Wipes	25-34015	\$19.99
Dispenser Box	Each	25-PUSHUPBOX	\$14.99

## Pre-Moistened Lens Wipes

- Safe on all AR coatings
- Easily carried in a wallet or purse
- 5.25" x 6" cloth



20 Wipe packs	99-MW20	\$2.59
24 Boxes (Case)	99-MW20C	\$37.99

## Microfiber Pouches

Drawstring Pouches are handmade using our highest quality microfiber. They are a great alternative to hard cases and are perfect for cleaning lenses.

- Double drawstring ensures a tight closure
- Sold in 10 packs per color



Black	42-OSDSBLKMF	\$19.99
Gray	42-OSDSGRMF	\$19.99
Navy	42-OSDSNAMF	\$19.99
White	42-OSDSWHTMF	\$19.99



# Premium Microfiber Cloths

84¢  
each

These high thread-count cloths are made of the best quality microfiber available. They are heavy-weight, resilient and incredibly smooth. The microfiber properties allow for superior cleaning even without a spray cleaner. OptiSource cloths are safe on AR coatings, all lenses, screens, and monitors.

- Silky weave traps dust and oils for safe cleaning
- 6" x 7" silky, close-knit fabric
- Packaged 100 to a bag, one color per bag

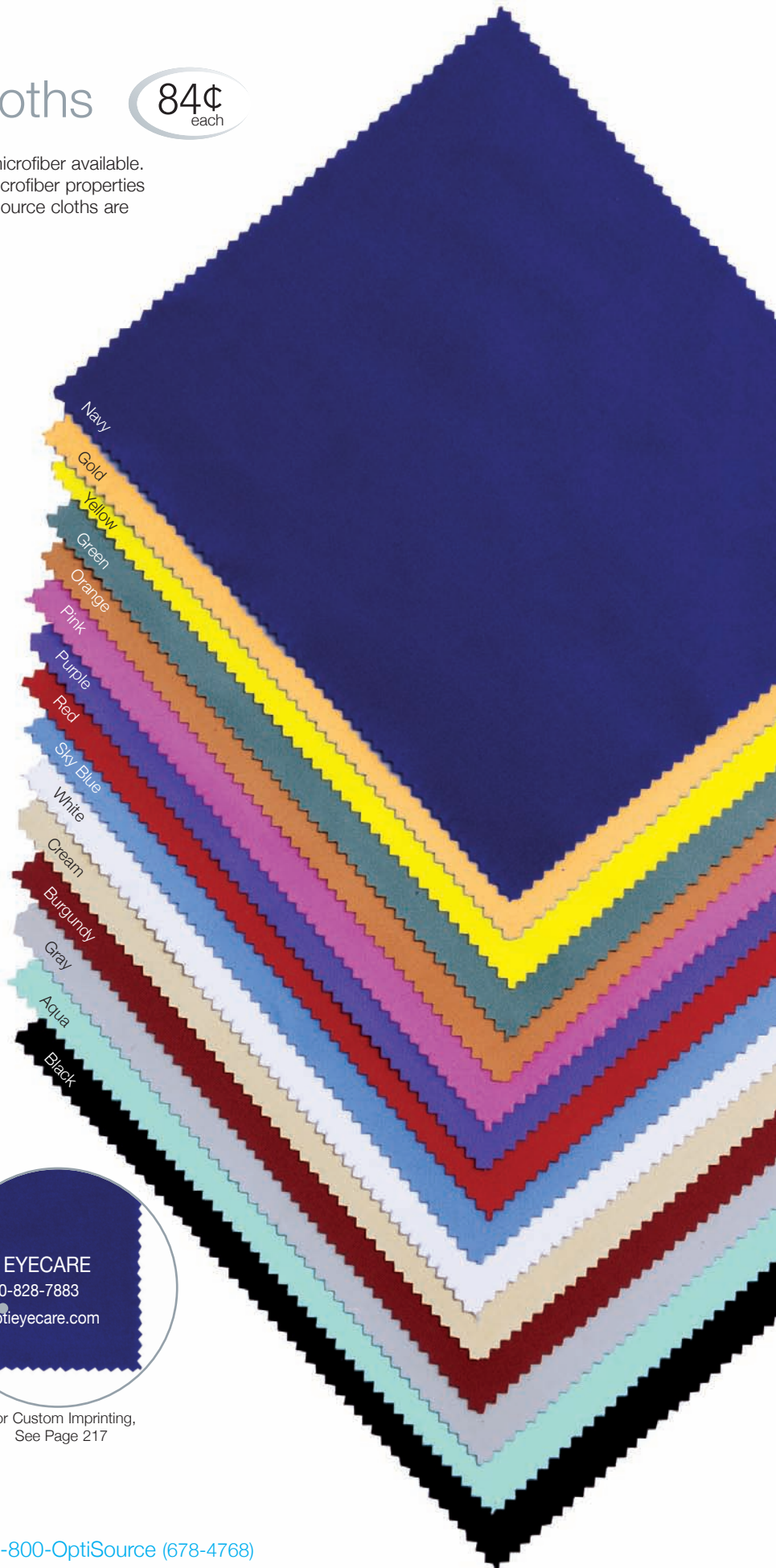

## Loose Zig-Zag Edge

Navy	33-LCNALZ
Gold	33-LCGLLZ
Yellow	33-LCYELZ
Green	33-LCGNLZ
Orange	33-LCORLZ
Pink	33-LCPKLZ
Purple	33-LCPRLZ
Red	33-LCRELZ
Sky Blue	33-LCSBLZ
White	33-LCWHLZ
Cream	33-LCCRLZ
Burgundy	33-LCBULZ
Gray	33-LCGRLZ
Aqua	33-LCAQLZ
Black	33-LCBLLZ



\* For imprinting add "PL" to the code + \$0.10.

For Custom Imprinting,  
See Page 217

# Clear View Cloth-In-Case

99¢  
each



Our soft and silky microfiber cloths are available in a handy carrying case with an insert card.

- 6" x 7" Cloth
- Packaged 100 to a box, one color per box



For Custom Imprinting Information, See Page 217

Navy	33-LCNACZ
Gold	33-LCGLCZ
Yellow	33-LCYECZ
Green	33-LCGNCZ
Orange	33-LCORCZ
Pink	33-LCPKCZ
Purple	33-LCPRCZ
Red	33-LCRECZ
Sky Blue	33-LCSBCZ
White	33-LCWHCZ
Cream	33-LCCRCZ
Burgundy	33-LCBUCZ
Gray	33-LCGRCZ
Aqua	33-LCAQCZ
Black	33-LCBLCZ



\*See previous page for Full Color Selection.  
For imprinting add "PL" to the code + \$0.10.

Imprinted cloth does not include card insert so that imprint art can be seen through plastic case.



# Holiday Cloths

94¢  
each

Spread some holiday cheer in any season! Our festive holiday microfiber cloths are a great premium item for your invaluable customers. All designs are available with or without your custom imprinting.

- 6" x 7" silky, close-knit fabric
- Sold in bags of 100 cloths per design
- Minimum order for custom imprinting is 500 cloths per design

\* For imprinting add "PL" to the code + \$0.15.  
Allow six weeks for processing.



33-LCH13 Merry Christmas (blue)



33-LCH9 Happy Holiday Snowman



33-LCH6 Thanksgiving Cornucopia



33-LCH12 Merry Christmas (red)



33-LCH10 Season's Greeting



33-LCH5 Happy Thanksgiving



33-LCH11 Happy Hanukkah



33-LCH3 July 4th Balloons



33-LCH4 July 4th Celebration





33-LCH1 Halloween Scarecrow



33-LCH2 Halloween Pumpkin



33-LCH7 Valentine's Day



33-LCH8 Valentine's Day Hearts

## Imprint Samples

- All holiday cloths are available for custom imprinting
- Allow six weeks for processing



Your Imprint Here



## LENS CLEANERS

### Chamois Cloths

- Thick, heavy-weight cloth
- Flocked texture cleans and absorbs in seconds
- 6" x 7"
- Sold in bag of 100



33-LCLARZGRL Each \$ .99

### XtremeVue Full Color Printing

We can transfer any photo-quality picture or artwork onto microfiber cloths! Put a picture of your optical storefront, interior or even your best selling frame on a cloth. The possibilities are endless!

- 6" x 7", other sizes available
- Brilliant high resolution images
- 1,000 piece minimum
- Novel giveaway



33-EXTREME Each \$1.49

### Lab Size Microfiber Cloths

\$3.99  
each

- Three Materials Available:
  - Terry - a looped knit just like terry cloth clothing
  - Suede - thick flocked material that is very soft and absorbent
  - Microfiber - soft and silky fabric
- Large 12" x 15" size



Terry Cloth	33-LCLTTLBLU
Suede Cloth	33-LCLTSLBLU
Black Microfiber Cloth	33-LABCLOTHBLK
Gray Microfiber Cloth	33-LABCLOTHGRY

### Economy Cleaning Cloths

29¢  
each

This smaller, lighter-weight cloth is an economical alternative to our premium microfiber cloths.



- 3.5" x 7"
- Packaged 100 to a bag, one color per bag

Sky Blue Economy Cloth	33-ECONOSB
Green Economy Cloth	33-ECONOGN
Pink Economy Cloth	33-ECONOPI
Yellow Economy Cloth	33-ECONOYE

# Custom Imprinting Services

## Lens Cleaning Cloth Add-On Options

OptiSource offers the largest variety of customization and personalization for lens cleaning cloths. Our services are unique, affordable, and easy to use. We require low-quantity minimums and offer quick turnaround times. Our in-house art department works with all file types and can enhance your artwork to maximize printing quality.

- See previous page for our unique full color printed ExtremeVue Microfiber cloths



### One-Color Printing

Our customers' favorite printing option

Personalize your cloths with your company's information. OptiSource specializes in personalizing any of our cloth offerings with your company's information, logo, marketing message, etc. One color printing is an efficient way to show off your company identity. 1,000 piece minimum.



### Two-Color Printing

Add a custom flair to your cloth printing

If your company logo is two colors, this printing option is a home run! Keep your brand consistent. Pick from any two colors to create a truly custom cloth. 1,000 piece minimum.

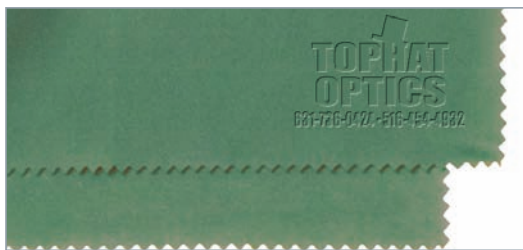

### Hot-Stamp Embossing

Create a unique look on cloths this year

Our hot-stamp embossing leaves a subtle engraved impression that separates your cloth from the rest! Embossing has an expensive look and feel and can match the look of designer eyeglass case embossing. 1,000 piece minimum.



### Plastic Carrying Case

Credit-card size carrying case keeps cloths clean and handy

This handy plastic carrying case keeps cloths free of dirt or dust that may collect in glove compartments, drawers, and purses. Perfect size for stashing in pockets and purses or for inserting a business card. 1,000 piece minimum.

Printing is done on the cloth, not the case.



### Hand-Stitched Edge

Custom stitching adds an elegant look to cloths

Looking for a way to add value and differentiate your cloth from the rest? Stitched edges are hand sewn and add a classy finish to standard zig-zag cloth edges. 1,000 piece minimum.



**0-9**

3D Glasses / Clip-Ons	184
3-in-1 Lens Inspection Station	17
3M Blocks	34
3M Hydrophobic Pads	26
3M Leap Pads	26
3M Press-On Lenses	189
3M Surface Saver Knife Blade Handle	50
3M Surface Saver Tapes	51

**A**

Acetate Lens Interliners	98
Acetate Temple Tips	105
Acetone	14
Acetone Substitute	14
Adjustment Pliers	59
Alcohol	14
Alcohol Pads	122
All Off Marking Ink Remover	7
Alloy	42
Angling Pliers	64
Anti-Fog Lens Cleaner	208
Anti-Slip Edging Solutions	26, 30-31
Anvil Bench Block	88
AR Remover	6

**B**

Backside Coating	44
Bags	202
Ball Cutters	54
Basic Collection - Readers	153-154
Batteries	124
Bench Block	88
Bent Post Pliers	63
Beveling Tool	56
BioFeel Nose Pads	100
Blade Readers	139
Blades	57, 85
Blocking Alloy	42
Blocking Pads	26-29
Blocks	32-34
Blue Chip Lens Protectors	26
Bridge Reducing Pliers	64
Bubble Contact Lens Cases	192
Buffing Pads	38
Bulbs	123-124
Bushings	94-95

**C**

Cablz Retainers	181
Calipers	89
Camera Phone Slit Lamp Adapter	108
Carbide Blades	36
Cases	163-173
Chain Nose Pliers	62, 65, 67, 75, 80
Chains	174-181
Chamfer Tool	56

Charts, Exam	116
Chem Tempering Salts	52
Chemistrie Clip-Ons	155
Children's Eyeglass Cases	173
Chin Rest Papers	112
China Markers	13
Chuck Protectors	30
Chucks	34
Clamshell Cases	163-167
Clavulus Hand Press	88
Cleaners	204-210
Cleaning Cloths	210-217
Clear Lens Protectors	30
Clear View Lens Cleaner	204
Clip-Ons	156-162
Cloths	210-217
Cobalt King Blocking Pads	27-29
Coil Low Vision Aids	186
Cold Dip Scratch Coat	6
Compression Sleeve Pliers	58-59, 73, 76
Compression Sleeve Removal Tool	56
Compression Sleeves	95
Contact Lens Cases	190-195
Contact Lens Handling	117
Contact Lens Travel Kit	194
Coolant	37
Coolant Pumps	37
Cords	174-181
CR-39 Neutralizer	8
Crimson King Blocking Pads	27-29
Crown Salt	52
Curved Plastic Tool Rack	81
Custom Clean	206-207
Cutter Blades	36, 54
Cutting Pliers	68-69, 72, 80
Cylinder Machine Reception Chucks	44

**D**

Deblockers	34, 70
Defoamers	37
Denatured Alcohol	14
Deodorizer	6
Dial-a-Date Contact Lens Cases	195
Diamond Wheels	54
DigiCase Contact Lens Cases	195
Digital Caliper	89
Digital Polish Tools	42
Dispenser Bottle	14
Dispensing Trays	201
Displays	10, 126-135, 196-197, 201, 208
Distometer	90
DMV Products	117
Dome Nuts	95
Double Spindle Bench Polisher	24
Drawers	99
Drill Bits	56
Dry AR Remover	6

Dry Dye Packets	10
Dry Eye Sunglasses	185
Dye Cleaner / Remover	14
Dye Unit	19
Dyes	9-11

**E**

Ear-Lock Temple Ends	104
Economy Blue Blocking Pads	27-29
Edge Pen	12
Edge Polish	12, 61
Edge Polisher	24
Edger Chucks	34
Edger Coolant	37
Edger Pumps	37
Edging Blocks	32-34
Edging Pads	26-29
Edging Wheels	35
Elite Collection - Readers	150-151
Exam Equipment	90, 108-109, 115-118
Eye Charts	116
Eye Patches	110-111, 113
Eye Protection	110-114
Eye Shields	112-114
Eyeglass Cases	163-173
Eyeglass Holders	126-135, 174-181, 196-197, 200
Eyeglass Lights	118
Eyeglass Repair Kit	92
Eyeglass Shipping Case	42
Eyeglasses Patches	110
Eyeglasses Retainers	174-181
Eyewear Displays	126-135, 196-197, 200
Eyewire Pliers	60-61, 71, 78
Eyewire Screws	96-97

**F**

Figure 8 Interliner	98
Files	86
Fining Pads	45-49
Finished Job Cases	42
Finishing Wheels	35
Fit Over Sunglasses	182-184
Flat Packs	190
Flip-Top Flat Packs	190
Foam Temple Pads	104
Fog Free Lens Cleaner	208
Folding Reading Glasses	137-138
Frame Displays	196-197, 200
Frame Parts Drawer System	99
Frame Repair Tools	88
Frame Tags	106
Frame Warmers	20

**G**

Generator Blades / Wheels	54
Gift Kits	204-210
Glass Beads	20
Gloves	12

Gradient System	19
Gripping Pliers	66-67, 74-75, 76, 79
Groover	22

**H**

Hammer / Mallets	84
Hand Cleaner	14
Hand Edger Wheels	23,35
Hand Edgers	23
Hand Tools	56-90
Handle Sleeves	81
Hang Aroundz Readers	140
Hardcoat	44
Head Displays	200
Heat Shrink Temple Covers	99
Heat Transfer Fluid (HTF)	8
Helping Hands	88
Hex Nut Wrenches	85
Hex Nuts	95
Hinge Screws	96
Hockey Puck	88
Holiday Microfiber Cloths	214-215
Honing Sticks	36
Hook-On Sunglasses	112
Horizon Cutter Blades	36
Horizontal Prism Bar	117
Hot Air Frame Warmer	20
Hot Dip Scratch Coat	6
HTF	8
HydroKing Blocking Pads	27-29
Hydrophobic Edging Solutions	26, 30-31
Hydrophobic Pads	27-30

**I**

Imprinting	90, 163, 190, 204-217
Inclination Pliers	65
Ink Marking Removers	7, 14
Interliner	98
Intermediary Film Pads	31
Ishihara Book	117
Isopropyl Alcohol	14

**J**

Job Tray Cleaner	43
Job Trays	43
Key Chain Screwdriver	204-205

**K**

Kimwipes	211
Kodak Lens Clip-On Sunglasses	156-158
Kodak Lens Folding Reading Glasses	137

**L**

Lab Fresh	6
Lab Snips	84
Lady's Pliers	76-80
Laps	52
Latex Gloves	12

Leap Pads	26-29
Leather Contact Lens Cases	191
Lens Aligning Pliers	60, 72, 78
Lens Calipers	89
Lens Cleaner Kits	204-210
Lens Cleaners	204-210
Lens Clock	57
Lens Display	10
Lens Dyes	9-11
Lens Edge Pen	12
Lens Edge Polisher	24
Lens Groovers	22
Lens Holders	18
Lens Hole Gauge	85
Lens Inspection Station	17
Lens Inspection Systems	17, 18, 21
Lens Interliners	98
Lens Marking Inks / Pens	13
Lens Pens	12
Lens Polishes	39, 53
Lens Prep	14
Lens Protection Discs	26, 30
Lens Sizing Pliers	61
Lens Wipes	211
Lensometer	21
Lensometer Ink	13
Light Specs Reading Glasses	138
Line Hook	56
Little Giant Submersible Pumps	37
Low Vision Aids	186-189

**M**

MacuHealth	119
Magnetic Tool Holder	81
Magnifiers	89, 186-189
Mallet	84
Markers	13
Marking Ink Removers	7, 14
Marking Inks	13
Matched Wheels Set	35
Mechanical Gradient System	19
Metal Blocks	34
Microfiber Cloths	210-217
Microfiber Pouches	211
Mirrors	198-199
Moisture Chambers	113
MultiMeter	18

**N**

Necklace Eyeglass Holders	178-179
Neutralizer	8
Nitrile Gloves	12
Non-Woven Bags	202
Nose Guard	113
Nose Pad Pliers	62-63, 74, 77
Nose Pad Screws	97
Nose Pads	100-103

Numont Pliers	63
Nut Gripper	85
Nuts	95
Nylon Gripping Pliers	66-67, 74-75, 76, 79
Nylon Jaw Pliers	66, 71, 77

**O**

Occluders	112, 114
Ophthalmic Products	120-122
Optical Displays	196-197, 200
OptiPets / OptiNoses	126-135

**P**

PAL Fitting Tool	90
PAL Identifier	17
Paper Bags	202
Paper Temple Sunglasses	112
Pattern Blanks	39
PCD Cutters	36, 54
PD Meters	109
PD Rulers	90
Pen Lights	118
Pharmaceuticals	120-122
Phone Adapter for Slit Lamp	108
Photochromic Salt	52
Pint-Size Pans and Lids	24
Plastic Bags	202
Plastic Blocks	32-33
Plastic Eyeglass Cases	173
Plastic Laps	52
Plastic Test Lenses	36
Plier Sleeves	81
Pliers	58-83
Pod Reading Glasses	138
Polariscope	17
Polishes	39, 53
Polishing Machine	24
Polishing Pads	38
Polishing Pads	45-49
Polishing Pen	12
Polishing Sticks	39
Polishing Wheel	39
Polycarbonate Dyes	11
Polycarbonate Edge Glaze	12
Posi Blocks	32
Post-Mydriatics	112
Preferred Collection - Readers	141-149
Premoistened Lens Wipes	211
Press-On Lenses	189
Prism Bar	117
Progressive Marking Ink Remover	7
Pupilometers	109

**R**

Reach Nuts	94
Reader Collections	141-154
Reading Glasses	136-154



Reception Chucks	44
Replacement Blades	85
Retail Bags	202
Retainers	174-181
Retruing Service	36, 54
Rhinestone Kit	106
Riki Pads	30
Rimless Assembly Measuring Tool	89
Rimless Bushings	94, 97
Rimless Caps	94
Rimless Compression Sleeves	95, 97
Rimless Driver-Bit Set	56
Rimless Hardware / Screws	94, 97
Rimless Omni-Nut Assembly	94
Rimless Pliers	58-59, 73, 76
Rimless Tools	58-80
Rip Cord - Microfiber Cloth	210
Riveting Hammers	84
Roll Up Sunglasses	112
Rouge	39
Roughing Wheels	35

## S

Salt Pan Frame Warmer	20
Salts	52
Sani-Cloth	122
Scratch Coat	6
Screw Extraction Pliers	65
Screw Extractor	87
Screw Finisher Tool	56
Screw Gripper	85
Screwdriver Set	57
Screwdrivers	57, 85
Screws	92-97
Scribe Tool	56
SecurEdge Blocking Pads	27-29
Semi-Hard Cases	168-169
Semi-Rimless Pliers	58-80
Shade Control Clip-Ons	160-162
Shrink Tubing	99
Sleeved Hinge Screws	97
Slip-In Cases	170-172
Slip-In Post-Mydriatics	112
Slit Lamp Camera Phone Adapter	108
Snapit Eyeglass Repair Kit	92
Snapit Screws	92-93
Snipe Nose Pliers	65, 67-68, 75, 80
Snips	84
Soft Grip Contact Lens Cases	194
Solar Shields	182-185
Soldering Clamps	84
Solvents	7, 14
Spin-On UV-Hardcoat	44
Spring Hinge Screws	96
Squeeze Lens Cleaner	208
Star Nuts	95
Stick-On Nose Pads	103

Submersible Pumps	37
Substitone	14
Sun Clips	156-162
Sunglass Flat Packs	190
Sunglasses	182-185
Super Hydro Anti-Slip Spray	31
Super IFP	31
Surface Saver Blades	50
Surface Saver Tapes	51
Surfacing Pads	45-49

## T

Tabletop Lumifier	89
Tape Dispenser System	50
Tempering Salts	52
Temple Bending Pliers	64
Temple Locks	104
Temple Tips / Ends	104-105
Test Lenses	36
Three-Piece Adjusting Pliers	59
Tin Pans / Lids	18
Tint Display	10
Tinting Lens Holders	18
Tinting Unit	19
Tints	9-11
Titanium Pliers	71-75
Tool Cases	81
Tool Holders	81
Tool Kits	82-83
Tool Sleeve Replacement	81
Tophats	94
Tray Cleaner	43
Trays	43
Trial Frames	115
Trial Lenses	115
Truing Sticks	36
Tweezers	84

## U

Ultimate Collection - Readers	152
Ultrasonic Cleaners	16
Ultrasonic Cleaning Fluid	14
UV Dyes	10
UV Formulas	4-5
UV Hardcoat	44
UV Meter	18

## V

Vertexometer	90
Visor Clips	200

## W

Washers	95
Wave Lens Cleaners	205
Weco Blocks	32
Wheels	35
Wooden PD Ruler	90

# Terms and Conditions

## Copyright and Trademark Information:

The materials contained in this catalog are copyright 2008 OptiSource International, Inc. You may not distribute, modify, transmit, reuse, report, or use the contents of the catalog for public or commercial purposes, with the exception of brief quotes in professional or trade publications. OptiSource is a registered trademark of OptiSource International, Inc. All trademarks appearing herein are acknowledged. The name of OptiSource International, Inc. or any of the trademarks or logos used herein may not be used in any manner without specific, written prior permission. You should assume that everything you see or read in this catalog is copyrighted or subject to trademark protection, unless otherwise noted, and may not be used except as provided in these Terms and Conditions without the written permission of OptiSource.

## General Information:

The information contained in this catalog is subject to change without notice. While OptiSource has used reasonable efforts to include accurate and up-to-date information, OptiSource makes no warranties or representations as to its accuracy. OptiSource assumes no liability or responsibility for any errors or omissions in the content. OptiSource may at any time revise these Terms and Conditions. You are bound by any such revisions. In the event a product is listed at an incorrect price or with incorrect information due to typographical error or error in pricing or product information received from our suppliers, OptiSource shall have the right to refuse or cancel any orders placed for product listed at the incorrect price. OptiSource shall have the right to refuse or cancel any such orders whether or not the order has been confirmed and your credit card charged. If your credit card has already been charged for the purchase and your order is canceled, OptiSource shall immediately issue a credit to your credit card account in the amount of the charge.

## Warranties:

Every third-party product you buy from OptiSource is backed first by the product manufacturer's warranty. OptiSource's 30-day limited warranty against defects may also apply. That warranty provides for either repair or replacement (at OptiSource's sole discretion) of merchandise confirmed as defective by either the manufacturer or OptiSource. We will assist customers whenever possible in gaining satisfaction with product manufacturers. No returns will be accepted when the manufacturer's or distributor's return policies supersede ours.

## Order Acceptance Policy:

All orders are accepted in accordance with the Terms and Conditions set forth herein. OptiSource reserves the right at any time after receipt of your order to accept or decline your order for any reason. OptiSource reserves the right at any time after receipt of your order, without prior notice to you, to supply less than the quantity you ordered of any item. All orders placed over USD \$2,000 must obtain credit pre-approval.

Following acceptance by Seller, orders are not subject to cancellation or modification, except upon written approval by Seller, and shall be subject to cancellation charges. OptiSource reserves the right to correct and amend any typographical errors.

All orders placed by the Buyer are binding. Buyer agrees that Buyer is wholly responsible for the actions of Buyer's employees, agents or representatives. If an employee of Buyer places an order unbeknownst to its management, Buyer is responsible for said person's actions, and Buyer assumes all responsibilities, whether authorized or not. Following written acceptance of or by signing for packages, Buyer agrees that Buyer authorized the purchase and accepts the terms and conditions of the sale with Seller. The Buyer's employee, agent or representative is acting on behalf of the Buyer, and by signing and receiving the package, the Buyer agrees to the Terms and Conditions of purchase and is responsible for payment of the merchandise.

Buyer is hereby notified that for the purposes of quality control, training, order and shipping accuracy, Seller may monitor agreements to purchase. This agreement is the policy of the Seller. This policy supersedes any arrangement the Buyer may have with a third-party billing or buying group. This policy is non-negotiable and cannot be modified or compromised at any time by anyone, including Seller's employees or any buying group.

## Limitations of Liability and Indemnity:

In no event shall OptiSource or any of its subsidiaries or affiliates be liable for any indirect, special, incidental or consequential damages, including but not limited to loss of use, loss of data, loss of business, or loss of profits. Some localities do not allow the exclusion or limitation of incidental or consequential damages, so the above limitation or exclusion may not apply to you. Seller assumes no liability for damage and/or injury resulting from use or misuse of equipment or supplies supplied by Seller. In no event will Seller be liable for indirect or consequential damages whatsoever resulting from loss of use, data or profits arising out of, or in connection with, the use or misuse of Seller's product. Buyer agrees to indemnify and hold the Seller harmless for any expense or loss arising out of, or resulting from, the installation of said product by Buyer.

## Return of Product and Refused Shipments:

All return claims must be made within 30 days of receipt of goods. All returns must be authorized by OptiSource and accompanied by a Return Authorization number. Claims for damages and shortages must be made within 15 days of the date of delivery. All returns must be shipped freight prepaid by Buyer. Absolutely no returns will be accepted after 60 days of receipt of goods. All unauthorized returns will be refused by Seller. All authorized returns are subject to a restocking and transportation fee of 25% of the entire invoice in question, unless Buyer chooses to exchange for another comparable product. Any products omitted from returned package will automatically be billed at full price. All free items must be returned with original invoice. Returns are subject to Seller's prior inspection and analysis to verify that merchandise has not been mishandled, altered or contaminated in any way. All products returned to Seller due to refusal of acceptance by Buyer, without Seller's authorization, will be subject to a 25% restocking and transportation charge.

Special-design and custom-constructed or custom-formulated merchandise is not returnable. Contact customer service for return authorization at 1-800-OPTISOURCE (678-4768).

3 Easy Ways To Order...

1-800-OptiSource (678-4768) Fax 631-924-8375 [www.1-800-OptiSource.com](http://www.1-800-OptiSource.com)







# NEW & IMPROVED DESIGN

Needle Tip for Easier Insertion  
Breaks Cleaner, Smoother, and Flatter!

**Snapit**<sup>TM</sup>  
frame screws

For the same price or less than other premium frame screws,  
Snapit turns dreaded repairs into a simple task.



Screw it in



Snap it off

Assorted Screw Wheel



Contains 10 of the best selling sizes (250 Screws)  
Available in Silver or Gold

U.S. Patent Numbers 8070403, 8375546, 8556556





**The Optical Supply Resource**

1-800-OptiSource (678-4768)

International: 631-924-8360

Fax: 631-924-8375

[www.1-800-OptiSource.com](http://www.1-800-OptiSource.com)

[info@1-800-OptiSource.com](mailto:info@1-800-OptiSource.com)

